



NEHRP Recommended Seismic Provisions

for New Buildings and Other Structures

FEMA P-750 / 2009 Edition



FEMA



NEHRP (National Earthquake Hazards Reduction Program)

Recommended Seismic Provisions

for New Buildings and Other Structures (FEMA P-750)

2009 Edition

Prepared for the Federal Emergency Management Agency of the
U.S. Department of Homeland Security
By the Building Seismic Safety Council of the
National Institute of Building Sciences

BUILDING SEISMIC SAFETY COUNCIL
A council of the National Institute of Building Sciences
Washington, D.C.
2009

NOTICE: Any opinions, findings, conclusions, or recommendations expressed in this publication do not necessarily reflect the views of the Federal Emergency Management Agency. Additionally, neither FEMA nor any of its employees make any warranty, expressed or implied, nor assume any legal liability or responsibility for the accuracy, completeness, or usefulness of any information, product, or process included in this publication.

The **Building Seismic Safety Council** (BSSC) was established in 1979 under the auspices of the National Institute of Building Sciences as a forum-based mechanism for dealing with the complex regulatory, technical, social, and economic issues involved in developing and promulgating building earthquake hazard mitigation regulatory provisions that are national in scope. By bringing together in the BSSC all of the needed expertise and all relevant public and private interests, it was believed that issues related to the seismic safety of the built environment could be resolved and jurisdictional problems overcome through authoritative guidance and assistance backed by a broad consensus.

The BSSC is an independent, voluntary membership body representing a wide variety of building community interests. Its fundamental purpose is to enhance public safety by providing a national forum that fosters improved seismic safety provisions for use by the building community in the planning, design, construction, regulation, and utilization of buildings.

This report was prepared under Contract HSFEHQ-04-C-0465 between the Federal Emergency Management Agency and the National Institute of Building Sciences.

For further information on Building Seismic Safety Council activities and products, see the Council's website (www.bssconline.org) or contact the Building Seismic Safety Council, National Institute of Building Sciences, 1090 Vermont, Avenue, N.W., Suite 700, Washington, D.C. 20005; phone 202-289-7800; fax 202-289-1092; e-mail bssc@nibs.org.

Copies of this report on CD Rom may be obtained from the FEMA Publication Distribution Facility at 1-800-480-2520. Limited paper copies also will be available. The report can also be downloaded in pdf form from the BSSC website at www.bssconline.org.

The National Institute of Building Sciences and its Building Seismic Safety Council caution users of this *Provisions* document to be alert to patent and copyright concerns especially when applying prescriptive requirements.

FOREWORD

One of the goals of the Federal Emergency Management Agency (FEMA) and the National Earthquake Hazards Reduction Program (NEHRP) is to encourage design and building practices that address the earthquake hazard and minimize the resulting risk of damage and injury. Publication of the 2009 edition of the *NEHRP Recommended Seismic Provisions for New Buildings and Other Structures* (FEMA P-750) reaffirms FEMA's ongoing support of efforts to achieve this goal. First published in 1985, the 2009 edition of the *Provisions* marks the seventh in a series of updates to the document and several complementary publications. FEMA is proud to have sponsored this project conducted by the Building Seismic Safety Council (BSSC) of National Institute of Building Sciences (NIBS) and continues to encourage the widespread dissemination and voluntary use of this state-of-art consensus resource document.

In contrast to the earlier editions of the *Provisions* which resulted from three-year update projects, the 2009 edition is the first resulting from a five-year update effort that allowed the BSSC's Provisions Update Committee (PUC) to make some major changes in both the substance and the format of the *Provisions* document. The most significant change involves the adoption by reference of the national consensus design loads standard, ASCE/SEI 7-05, *Minimum Design Loads for Buildings and Other Structures*, including the related consensus standards referenced therein and Supplements 1 and 2. Part 1 of this document includes consensus-approved modifications of the seismic requirements in the standard. Among these modifications is the adoption of new seismic design maps based on seismic hazard maps issued in 2008 by the U.S. Geological Survey (USGS) along with some design-related adjustments. Another major change has been made to the accompanying Commentary, previously issued as a separate volume but now included as Part 2 of the 2009 *Provisions*. The content of the Commentary has been completely rewritten to provide users with an up-to-date, user friendly explanation of how to design using the *Provisions* and the reference standard. Part 3 of the 2009 *Provisions* consists of a series of resource papers intended to clarify aspects of the *Provisions*, stimulate consideration of and feedback from the design community on new seismic design concepts and procedures, and/or encourage the development and adoption of new requirements in ASCE/SEI 7 and the standards referenced therein. Thus, the 2009 *Provisions* serves as a national resource intended for use by both design professionals and the standards- and codes-development community in fostering development of a built environment designed and constructed to protect building occupants from loss of life and serious injury and to reduce the total losses from future earthquakes.

FEMA wishes to express its deepest gratitude for the significant efforts of the over 200 volunteer experts as well as the BSSC Board of Direction, member organizations, consultants, and staff who made the 2009 *NEHRP Recommended Seismic Provisions* possible. Americans unfortunate enough to experience the earthquakes that will inevitably occur in the future will owe much, perhaps even their lives, to the contributions and dedication of these individuals. Without the expertise and efforts of these men and women, this document and all it represents with respect to earthquake risk mitigation would not have been possible.

Federal Emergency Management Agency

Page intentionally left blank.

PREFACE and ACKNOWLEDGEMENTS

Since its creation in 1979, the National Earthquake Hazard Reduction Program (NEHRP) has provided a framework for efforts to reduce the risk from earthquakes. The Building Seismic Safety Council (BSSC) is extremely proud to have been selected by the Federal Emergency Management Agency (FEMA) to play a role under NEHRP in improving the seismic resistance of the built environment. Further, the BSSC is pleased to mark the occasion of its thirtieth anniversary with delivery to FEMA of the consensus-approved 2009 *NEHRP Recommended Seismic Provisions for New Buildings and Other Structures*, the eighth edition of this landmark publication. The *Provisions* has evolved over the past three decades into a widely available, trusted, state-of-the-art seismic design resource document with requirements that have been adapted for use in the nation's model building codes and standards.

Work on the 2009 *Provisions* began in September 2004 when the National Institute of Building Sciences, the BSSC's parent organization, entered into a contract with FEMA for initiation of the 2009 *Provisions* update effort. Based on input from the BSSC member organization representatives and alternate representatives and the BSSC Board of Direction, individuals to serve on the 2009 Provisions Update Committee (PUC) and its Technical Subcommittees (TSs) and ad hoc Issue Teams were identified. The PUC and its TSs and ITs were fully established in 2005 as was a Seismic Design Procedures Review Group (SDPRG) charged to assess ongoing work by the U.S. Geological Survey (USGS) to update its seismic hazard maps. It is the collective efforts and expertise of the national experts serving on these groups that is reflected in the 2009 *Provisions*.

In recognition of the fact that the codes and standards arena now operates differently than it did in the past, the format of 2009 *Provisions* has been changed to focus more on exploration of new technologies and procedures and less on format and editorial changes. To this end, the national consensus design loads standard, *Minimum Design Loads for Building and Other Structures*, ASCE/SEI 7-05 (including Supplements 1 and 2), has been adopted as the primary reference standard of the *Provisions*. Areas of the standard in need of modification also were identified and proposals to do so were prepared and voted on by the membership. These modifications appear in Part 1 of this document and, together with ASCE/SEI 7-05 and the references cited therein, constitute the 2009 *Provisions*. (A summary of the results of the member organization ballots and comment resolution process is available from the BSSC upon written request and will be posted on the BSSC website at www.bssconline.org.)

A major effort also was made to rewrite the commentary to the *Provisions*. Until now, the commentary was published as a separate volume accompanying the *Provisions* and tended to explain the development of the existing requirements. For 2009, the commentary appears in Part 2 of this *Provisions* document and explains how to apply the *Provisions* requirements as articulated in ASCE/SEI 7-05 and the references cited therein. (Note that the Part 1 modifications to the standard are accompanied by their own commentary text.)

Part 3 of this volume is a collection of resource papers. Included are substantive proposals on topics that require further consideration by and feedback from the seismic design community before they become *Provisions* requirements as well as papers that clarify some aspects of the *Provisions* requirements. In addition, three of the appendices from the 2003 *Provisions* are still considered to include information of interest and they also are included in Part 3.

As in the past, the 2009 *Provisions* would not have been possible without the expertise, dedication, and countless hours of effort of the more than 200 dedicated volunteers who participated in the update process. The American people benefit immeasurably from their commitment to improving the seismic-resistance of the nation's buildings. A list of all those who participated in the 2009 *Provisions* update project is included as the Appendix

of this volume, but a few individuals and groups deserve special recognition. As Chairman of the BSSC Board of Direction, it is my pleasure to express heartfelt appreciation to:

- The members of the BSSC Provisions Update Committee, especially to PUC Chair Ronald Hamburger;
- The members of the Seismic Design Procedures Review Group, especially Chair Charles Kircher and Nicolas Luco of the USGS;
- FEMA Project Officers Michael Mahoney and Mai Tong and FEMA Subject Matter Expert Robert Hanson;
- Michael Valley who worked with the update committees to draft the Part 2 commentary to the 2009 *Provisions*;
- The representatives of the BSSC member organizations who devoted considerable time and attention to the four individual rounds of balloting that were required to produce the 2009 *Provisions* document; and
- The BSSC staff who work tirelessly behind the scenes to support all the update groups and who bring the finished product forward for acceptance.

Finally, I wish to thank the members of the BSSC Board of Direction who recognize the importance of this effort and provided sage advice throughout the update. We are all proud of the 2009 *NEHRP Recommended Seismic Provisions* and it is my pleasure to introduce them.

David Bonneville
Chairman, BSSC Board of Direction

CONTENTS

Foreword	iii
Preface and Acknowledgements	v
2009 NEHRP RECOMMENDED SEISMIC PROVISIONS FOR NEW BUILDINGS AND OTHER STRUCTURES: PART 1, PROVISIONS	1
1.1 Intent	3
1.2 Reference Document	3
Commentary to Sections 1.1 and 1.2.....	3
1.3 Modifications to ASCE/SEI 7-05	5
Chapter 11, Seismic Design Criteria	
Section 11.1.2, Scope	5
Section 11.2, Definitions	5
Section 11.3, Notation.....	5
Section 11.4, Seismic Ground Motion	6
Section 11.8, Geologic Hazards and Geotechnical Investigation.....	8
Commentary to Section 11.1.2.....	10
Commentary to Section 11.2.....	10
Commentary to Section 11.4.3 and 11.4.4	10
Commentary to Section 11.8.3.....	19
Chapter 12, Seismic Design Requirements for Building Structures	
Table 12.2-1, Design Coefficients and Factors for Basic Seismic-Force-Resisting Systems.....	21
Table 12.6-1, Permitted Analytical Procedures.....	25
Section 12.8.7, P-delta Limit.....	26
Section 12.11.2.2.1, Transfer of Anchorage Forces into Diaphragm	26
Section 12.11.2.2.3, Wood Diaphragms.....	27
Section 12.14.7.5.1, Transfer of Anchorage Forces into Diaphragm	27
Section 12.14.7.5.2, Wood Diaphragms.....	27
Section 12.14.8.1, Seismic Base Shear	27
Commentary to Section 12.6.....	28
Commentary to Section 12.8.7.....	28
Additional References for Chapter 12 Commentary	28
Chapter 13, Seismic Design Requirements for Nonstructural Elements	
Section 13.6.5.5, Additional Requirements [for Component Supports].....	29
Section 13.6.8.2, Fire Protection Sprinkler Systems in Seismic Design Category C.....	29
Section 13.6.8.3, Fire Protection Sprinkler Systems in Seismic Design Categories D through F.....	29
Commentary to Section 13.6.5.5	29
Commentary to Section 13.6.8.2.....	29
Chapter 14, Material Specific Seismic Design and Detailing Requirements	
Section 14.1, Steel.....	31
Section 14.2.2, Modifications to ACI 318.....	33
Section 14.2.3, Additional Detailing Requirements for Concrete Piles and Section 14.2.3.1, Concrete Pile Requirements for Seismic Design Category C.....	34

Section 14.2.3.2, Concrete Pile Requirements for Seismic Design Categories D through F.....	35
Section 14.2.4, Acceptance Criteria for Special Precast Structural Walls Based on Validation Testing	36
Section 14.4.5, Modifications to Chapter 1 of ACE 530/ASCE 5/TMS 402.....	40
Commentary to Section 14.1.1	40
Commentary to Section 14.1.4	40
Commentary to Section 14.2	41
Commentary to Section 14.2.3	42
Commentary to Section 14.2.4	43
Commentary to Section 14.4.5	53
Additional References for Chapter 14 Commentary	54
 Chapter 15, Seismic Design Requirements for Nonbuilding Structures	
Table 15.4-2, Seismic Coefficients for Nonbuilding Structures Not Similar to Buildings.....	57
Section 15.5.3, Steel Storage Racks	57
Section 15.6.2, Stacks and Chimneys.....	57
Section 15.7.6, Ground-Supported Storage Tanks for Liquids.....	58
Commentary to Section 15.5.3	58
Commentary to Section 15.6.2	58
Commentary to Section 15.7.6.1	59
Additional Reference for Chapter 15 Commentary	59
 Chapter 16, Seismic Response History Procedures	
Section 16.1.3.2, Three-dimensional Analysis	61
Commentary to Section 16.1.3.2	61
Additional References for Chapter 16 Commentary	62
 Chapter 18, Seismic Design Requirements for Structures with Damping Systems	
Section 18.3.1, Nonlinear Response History Procedure.....	63
Section 18.3.2, Nonlinear Static Procedure	63
 Chapter 19, Soil-Structure Interaction for Seismic Design	
Table 19.2-1, Values of G/G_o and V_s/V_{so}	65
Figure 19.2-1, Foundation Damping Factor	65
 Chapter 21, Site-Specific Ground Motion Procedures for Seismic Design	
Section 21.2, Ground Motion Hazard Analysis.....	67
Commentary to Section 21.2	67
Additional References for Chapter 21 Commentary	70
 Chapter 22, Seismic Ground Motion and Long-period Transition Maps	
Chapter 22	73
Commentary for New Chapter 22	92
 Chapter 23, Seismic Design Reference Documents	
Section 23.1, Consensus Standards and Other Reference Documents	95
 New Chapter 23, Vertical Ground Motions for Seismic Design	
Chapter 23	97
Commentary for New Chapter 23	98

2009 NEHRP RECOMMENDED SEISMIC PROVISIONS FOR NEW BUILDINGS AND OTHER STRUCTURES: PART 2, COMMENTARY TO ASCE/SEI 7-05 101

Commentary to Chapter 11, Seismic Design Criteria

C11.1	General	103
	C11.1.1 Purpose	103
	C11.1.2 Scope	103
	C11.1.4 Alternate Materials and Alternate Means and Methods of Construction	103
C11.4	Seismic Ground Motion Values	104
	C11.4.1 Mapped Acceleration Parameters	104
	C11.4.3 and C11.4.4 Site Coefficient and Adjusted Acceleration Parameters	104
	C11.4.5 Design Response Spectrum	105
	C11.4.7 Site-Specific Ground Motion Procedures	105
C11.5	Importance Factor and Occupancy Category	105
	C11.5.1 Importance Factor	106
	C11.5.2 Protected Access for Category IV Structures	106
C11.6	Seismic Design Categories	107
C11.7	Design Requirements for Seismic Design Category A	108
C11.8	Geologic Hazards and Geotechnical Investigation	109
	C11.8.1 Site Limitation for Seismic Design Categories E And F	109
	C11.8.3 Additional Geotechnical Investigation Report Requirements for Seismic Design Categories D through F	109
References	109

Commentary to Chapter 12, Seismic Design Requirements for Building Structures

C12.1	Structural Design Basis	111
	C12.1.1 Basic Requirements	111
	C12.1.2 Member Design, Connection Design, and Deformation Limit	113
	C12.1.3 Continuous Load Path and Interconnection	114
	C12.1.4 Connection to Supports	114
	C12.1.5 Foundation Design	114
	C12.1.6 Material Design and Detailing Requirements	114
C12.2	Structural System Selection	114
	C12.2.1 Selection and Limitations	114
	C12.2.2 Combinations of Framing Systems in Different Directions	116
	C12.2.3 Combinations of Framing Systems in the Same Direction	116
	C12.2.4 Combination of Framing Detailing Requirements	116
	C12.2.5 System Specific Requirements	116
C12.3	Diaphragm Flexibility, Configuration Irregularities, and Redundancy	117
	C12.3.1 Diaphragm Flexibility	117
	C12.3.2 Irregular and Regular Classification	118
	C12.3.3 Limitations and Additional Requirements for Systems with Structural Irregularities	119
	C12.3.4 Redundancy	121
C12.4	Seismic Load Effects and Combinations	123
	C12.4.1 Applicability	123
	C12.4.2 Seismic Load Effect	123
	C12.4.3 Seismic Load Effect Including Overstrength Factor	123
	C12.4.4 Minimum Upward Force For Horizontal Cantilevers for Seismic Design Categories D Through F	123
C12.5	Direction of Loading	124
C12.6	Analysis Selection Procedure	124
C12.7	Modeling Criteria	124
	C12.7.1 Foundation Modeling	124

	C12.7.2 Effective Seismic Weight.....	125
	C12.7.3 Structural Modeling	125
	C12.7.4 Interaction Effects	126
C12.8	Equivalent Lateral Force Procedure	126
	C12.8.1 Seismic Base Shear	126
	C12.8.2 Period Determination	127
	C12.8.3 Vertical Distribution of Seismic Forces	128
	C12.8.4 Horizontal Distribution of Forces	129
	C12.8.6 Story Drift Determination	130
	C12.8.7 P-delta Effects	132
C12.9	Modal Response Spectrum Analysis	133
	C12.9.1 Number of Modes	133
	C12.9.2 Modal Response Parameters	133
	C12.9.3 Combined Response Parameters	133
	C12.9.4 Scaling Design Values of Combined Response	134
	C12.9.5 Horizontal Shear Distribution	134
	C12.9.6 P-delta Effects	134
C12.10	Diaphragms, Chords, and Collectors	134
	C12.10.1 Diaphragm Design	134
C12.11	Structural Walls and Their Anchorage	135
	C12.11.1 Design for Out-of- Plane Forces	135
	C12.11.2 Anchorage of Concrete or Masonry Structural Walls	136
C12.12	Drift and Deformation	137
	C12.12.3 Building Separation.....	138
	C12.12.4 Deformation Compatibility for Seismic Design Categories D Through F.....	139
C12.13	Foundation Design.....	139
	C12.13.3 Foundation Load-Deformation Characteristics	139
	C12.13.4 Reduction of Foundation Overturning	140
	C12.13.5 Requirements for Structures Assigned to Seismic Design Category C.....	140
	C12.13.6 Requirements for Structures Assigned to Seismic Design Categories D Through F	141
C12.14	Simplified Alternative Structural Design Criteria for Simple Bearing Wall or Building Frame Systems	142
	C12.14.1 General.....	142
	C12.14.3 Seismic Load Effects and Combinations.....	142
	C12.14.7 Design and Detailing Requirements.....	143
	C12.14.8 Simplified Lateral Force Analysis Procedure	143
References	143

Commentary to Chapter 13, Seismic Design Requirements for Nonstructural Components

C13.1	General	145
	C13.1.1 Scope.....	147
	C13.1.2 Seismic Design Category	148
	C13.1.3 Component Importance Factor.....	148
	C13.1.4 Exemptions	149
	C13.1.5 Applicability of Nonstructural Component and Requirements	150
	C13.1.6 Reference Documents	150
	C13.1.7 Reference Documents Using Allowable Stress Design.....	150
C13.2	General Design Requirements	151
	C13.2.1 Applicable Requirements for Architectural, Mechanical, and Electrical Components, Supports, and Attachments.....	151
	C13.2.2 Special Certification Requirements For Designated Seismic Systems	151
	C13.2.3 Consequential Damage	151
	C13.2.4 Flexibility.....	152

	C13.2.5 Testing Alternative for Seismic Capacity Determination	152
	C13.2.6 Experience Data Alternative for Seismic Capacity Determination.....	153
	C13.2.7 Construction Documents.....	153
C13.3	Seismic Demands on Nonstructural Components	154
	C13.3.1 Seismic Design Force	154
	C13.3.2 Seismic Relative Displacements	156
C13.4	Nonstructural Component Anchorage	157
	C13.4.2 Anchors in Concrete or Masonry.....	157
	C13.4.3 Installation Conditions.....	158
	C13.4.4 Multiple Attachments	158
	C13.4.5 Power Actuated Fasteners.....	158
	C13.4.6 Friction Clips	158
C13.5	Architectural Components.....	159
	C13.5.1 General.....	159
	C13.5.2 Forces and Displacements	159
	C13.5.3 Exterior Nonstructural Wall Elements and Connections	159
	C13.5.5 Out-of-Plane Bending.....	160
	C13.5.6 Suspended Ceilings.....	160
	C13.5.7 Access Floors.....	161
	C13.5.8 Partitions.....	161
	C13.5.9 Glass in Glazed Curtain Walls, Glazed Storefronts, and Glazed Partitions.....	161
C13.6	Mechanical and Electrical Components	162
	C13.6.1 General.....	163
	C13.6.2 Component Period	163
	C13.6.3 Mechanical Components and C13.6.4 Electrical Components	164
	C13.6.5 Component Supports	164
	C13.6.6 Utility and Service Lines	164
	C13.6.7 HVAC Ductwork.....	165
	C13.6.8 Piping Systems.....	165
	C13.6.9 Boilers and Pressure Vessels	165
	C13.6.10 Elevator and Escalator Design Requirements.....	165
	C13.6.11 Other Mechanical and Electrical Components.....	166
References	166
 Commentary to Chapter 14, Material Specific Seismic Design and Detailing Requirements		
C14.0	Scope	169
C14.1	Steel	169
	C14.1.1 Reference Documents.....	169
	C14.1.2 Seismic Design Categories B and C	169
	C14.1.3 Seismic Design Categories D Through F.....	169
	C14.1.4 Cold-Formed Steel.....	169
	C14.1.5 Prescriptive Framing	170
	C14.1.6 Steel Deck Diaphragms	170
	C14.1.7 Steel Cables	170
	C14.1.8 Additional Detailing Requirements for Steel Piles in Seismic Design Categories D Through F.....	170
C14.2	Concrete	171
C14.3	Composite Steel and Concrete Structures	173
	C14.3.1 Reference Documents.....	173
	C14.3.2 Metal-Cased Concrete Piles.....	174
C14.4	Masonry 206.....	174
	C14.4.2 <i>R</i> Factors	174
	C14.4.3 Classification of Shear Walls.....	174

C14.4.6	Modifications to Chapter 2 of ACI 530/ASCE 5/TMS 402	174
C14.4.7	Modifications to Chapter 3 of ACI 530/ASCE 5/TMS 402	175
C14.4.8	Modifications to Chapter 6 of ACI 530/ASCE 5/TMS 402	175
C14.4.9	Modifications to ACI 530.1/ASCE 6/TMS 602	175
C14.5	Wood	175
C14.5.1	Reference Documents	175
C14.5.2	Framing	175
References	176

Commentary to Chapter 15, Seismic Design Requirements for Nonbuilding Structures

C15.1.1	Nonbuilding Structures	179
C15.1.2	Design	179
C15.1.3	Structural Analysis Procedure Selection	180
C15.2	Reference Documents	185
C15.3	Nonbuilding Structures Supported by Other Structures	186
C15.3.1	Less Than 25 Percent of Combined Weight Condition	186
C15.3.2	Greater Than or Equal to 25 Percent Combined Weight Condition	186
C15.4	Structural Design Requirements	187
C15.4.1	Design Basis	187
C15.4.2	Rigid Nonbuilding Structures	188
C15.4.3	Loads	188
C15.4.4	Fundamental Period	188
C15.4.8	Site-Specific Response Spectra	188
C15.5	Nonbuilding Structures Similar to Buildings	188
C15.5.1	General	188
C15.5.2	Pipe Racks	188
C15.5.3	Steel Storage Racks	188
C15.5.4	Electrical Power Generating Facilities	189
C15.5.5	Structural Towers for Tanks And Vessels	189
C15.5.6	Piers and Wharves	189
C15.6	General Requirements for Nonbuilding Structures Not Similar To Buildings	190
C15.6.1	Earth-Retaining Structures	190
C15.6.2	Stacks and Chimneys	190
C15.6.4	Special Hydraulic Structures	190
C15.6.5	Secondary Containment Systems	191
C15.6.6	Telecommunications Towers	191
C15.7	Tanks and Vessels	191
C15.7.1	General	191
C15.7.2	Design Basis	192
C15.7.3	Strength and Ductility	193
C15.7.4	Flexibility of Piping Attachments	193
C15.7.5	Anchorage	193
C15.7.6	Ground-Supported Storage Tanks for Liquids	193
C15.7.7	Water Storage and Water Treatment Tanks and Vessels	195
C15.7.8	Petrochemical and Industrial Tanks and Vessels Storing Liquids	195
C15.7.9	Ground-Supported Storage Tanks for Granular Materials	196
C15.7.10	Elevated Tanks and Vessels for Liquids and Granular Materials	197
C15.7.11	Boilers and Pressure Vessels	197
C15.7.12	Liquid and Gas Spheres	197
C15.7.13	Refrigerated Gas Liquid Storage Tanks and Vessels	197
C15.7.14	Horizontal, Saddle Supported Vessels for Liquid or Vapor Storage	198
References	199

Commentary to Chapter 16, Seismic Response History Procedures

C16.1	Linear Response History Procedure	201
C16.1.1	Analysis Requirements	201
C16.1.2	Modeling.....	201
C16.1.3	Ground Motion	202
C16.1.4	Response Parameters	203
C16.2	Nonlinear Response History Procedure.....	204
C16.2.1	Analysis Requirements	204
C16.2.2	Modeling.....	204
C16.2.3	Ground Motion and Other Loading	205
C16.2.4	Response Parameters.....	205
C16.2.5	Design Review	206
References	206

Commentary to Chapter 17, Seismic Design Requirements for Seismically Isolated Structures

C17.1	General	207
C17.1.1	Variations in Material Properties	208
C17.2	General Design Requirements	208
C17.2.4	Isolation System.....	209
C17.2.5	Structural System.....	209
C17.2.6	Elements of Structures and Nonstructural Components	209
C17.3	Ground Motion for Isolated Structures.....	209
C17.3.1	Design Spectra	209
C17.3.2	Ground Motion Histories	210
C17.4	Analysis Procedure Selection.....	210
C17.5	Equivalent Lateral Force Procedure	211
C17.5.3	Minimum Lateral Displacements.....	211
C17.5.4	Minimum Lateral Forces	212
C17.5.5	Vertical Distribution of Forces	213
C17.5.6	Drift Limits	213
C17.6	Dynamic Analysis Procedures.....	214
C17.7	Design Review	214
C17.8	Testing	214
C17.8.5	Design Properties of the Isolation System	215
References	216

Commentary to Chapter 18, Seismic Design Requirements for Structures with Damping Systems

C18.1	General	217
C18.2	General Design Requirements	217
C18.2.2	System Requirements	217
C18.2.4	Procedure Selection	217
C18.3	Nonlinear Procedures	219
C18.4	Response Spectrum Procedures and C18.5 Equivalent Lateral Force Procedure.....	219
C18.6	Damped Response Modification	221
C18.6.1	Damping Coefficient.....	221
C18.6.2	Effective Damping.....	222
C18.7	Seismic Load Conditions and Acceptance Criteria	222
References	222

Commentary to Chapter 19, Soil Structure Interaction for Seismic Design

C19.1	General	225
C19.2	Equivalent Lateral Load Procedure	226
C19.2.1	Base Shear	226

C19.2.2	Vertical Distribution of Seismic Forces	228
C19.2.3	Other Effects	229
C19.3	Modal Analysis Procedure.....	229
References	229

Commentary to Chapter 20, Site Classification Procedure for Seismic Design

C20.1	Site Classification	231
C20.3	Site Class Definitions	231
	C20.3.1 Site Class F	231
	C20.3.2 through C20.3.5	231
C20.4	Definitions of Site Class Parameters	231

Commentary to Chapter 21, Site-Specific Ground Motion Procedures for Seismic Design

	General	233
C21.1	Site Response Analysis.....	233
	C21.1.1 Base Ground Motions	233
	C21.1.2 Site Condition Modeling	234
	C21.1.3 Site Response Analysis and Computed Results	234
C21.2	Ground Motion Hazard Analysis.....	234
	C21.2.1 Probabilistic MCE.....	235
	C21.2.2 Deterministic MCE	235
C21.3	Design Response Spectrum	235
C21.4	Design Acceleration Parameters.....	235
References	235

Commentary to Chapter 22, Seismic Ground Motion and Long-Period Transition Maps

	Seismic Ground Motion Maps	237
	Long-Period Transition Maps	237
References	238

2009 NEHRP RECOMMENDED SEISMIC PROVISIONS FOR NEW BUILDINGS AND OTHER STRUCTURES: PART 3, RESOURCE PAPERS (RP) ON SPECIAL TOPICS IN SEISMIC DESIGN.....239

RP 1	Alternate Materials, Design, and Methods of Construction	241
RP 2	Nonlinear Static Procedure	243
RP 3	Seismic Response-History Analysis	247
RP 4	Foundation Geotechnical Ultimate Strength Design of Foundations and Foundation Load-Deformation Modeling.....	251
RP 5	Alternative Provisions for the Design of Piping Systems.....	259
RP 6	Other Nonbuilding Structures	263
RP 7	Special Requirements for Seismic Design of Structural Glued Laminated Timber (Gluam) Arch Members and Their Connections in Three-Hinge Arch Systems	267
RP 8	Appropriate Seismic Load Combinations for Base Plates, Anchorage, and Foundations	275
RP 9	Seismic Design Using Target Drift, Ductility, and Plastic Mechanisms as Performance Criteria	289
RP 10	Seismic Design Methodology for Precast Concrete Floor Diaphragms	311
RP 11	Shear Wall Load-Deflection Parameters and Performance Expectations.....	333
RP 12	Evaluation of Geologic Hazards and Determination of Seismic Lateral Earth Pressures.....	341
RP 13	Light-Frame Wall Systems with Wood Structural Panel Sheathing	365

APPENDIX, Participants in the BSSC 2009 Provisions Update Project.....373

2009 NEHRP RECOMMENDED SEISMIC PROVISIONS FOR NEW BUILDINGS AND OTHER STRUCTURES:

PART 1, PROVISIONS

Work on this 2009 edition of the NEHRP (National Earthquake Hazards Reduction Program) Recommended Seismic Provisions for New Buildings and Other Structures began in September 2004 when the National Institute of Building Sciences, the parent organization of the Building Seismic Safety Council (BSSC), entered into a contract with Federal Emergency Management Agency (FEMA) for initiation of the 2009 Provisions update effort. During 2005, the BSSC member organization representatives and alternate representatives and the BSSC Board of Direction were asked to identify individuals to serve on the 2009 Provisions Update Committee (PUC) and its Technical Subcommittees (TSs) and to suggest topics for concentrated study by ad hoc Issue Teams.

The 2009 PUC and its eight Technical Subcommittees (TS) then were established to address document composition and management; design criteria and analysis and advanced technologies; mapping, foundations, and geotechnical considerations; concrete structures; masonry structures; steel and composite steel and concrete structures; wood structures; nonstructural components and nonbuilding structures. Three Issue Teams (ITs) also were established to focus on performance criteria, design parameters, and foundation design requirements. Further, given ongoing work by the U.S. Geological Survey (USGS) to update its seismic hazard maps, a Seismic Design Procedures Review Group (SDPRG) was established to consider the emerging maps and to re-examine the existing design maps and procedures that were introduced in the 1997 edition of the Provisions and that remained essentially unchanged for the 2000 and 2003 editions of the Provisions.

Work already done and decisions made prior to initiation of the 2009 Provisions update project recognized that the codes and standards arena has changed over the past decade and that those changes called for a refocusing of the Provisions on exploration of new technologies and procedures and less consideration of format and editorial changes. To this end, the initial efforts of the 2009 PUC and its TSs focused on adoption of the national load standard, Minimum Design Loads for Building and Other Structures, ASCE/SEI 7-05 (including Supplements No. 1 and No. 2), as the primary reference standard of the Provisions and the identification of parts of the 2003 Provisions that should be maintained as modifications to the standard or otherwise revised to reflect new knowledge and experience data. The result of this effort was a vote by the BSSC member organizations to adopt ASCE/SEI 7-05 by reference and for it to serve as the base document for the update cycle. Three modifications to standard, originally appendices to various chapters of the 2003 Provisions, had been deemed needed by the PUC and TSs and were approved as part of this vote by the membership for inclusion in the 2009 Provisions. As the update cycle progressed, additional modifications to the standard were prepared and voted on by the membership in three separate ballots. All these modifications appear in Part 1 of this document and, together with ASCE/SEI 7-05 and the references cited therein, constitute the 2009 Provisions. (A summary of the results of the member organization ballots and comment resolution process is available from the BSSC upon written request and will be posted on the BSSC website at www.bssconline.org.)

A major effort also was made to rewrite the commentary to the Provisions. Until now, the commentary was published in a separate volume and tended to explain the development of the requirements. For 2009, the commentary appears in Part 2 of this Provisions volume and explains how to apply the Provisions requirements as articulated in ASCE/SEI 7-05 and the references cited therein. (Note that the Part 1 modifications to the standard are accompanied by appropriate commentary text included in Part 1.)

Part 3 of this Provisions volume introduces new procedures or provisions not currently contained in the referenced standards for consideration and experimental use by the design community, researchers, and standards- and code-development organizations and feedback from these users is encouraged. Part 3 also presents individual summaries of ongoing committee work that awaits additional research before being submitted to the BSSC membership for consensus

approval and provides useful guidance on the application of Part 1 requirements, either as a discussion of an overall approach or as a detailed procedure.

1.1 INTENT

The *NEHRP Recommended Seismic Provisions for New Buildings and Other Structures* presents the minimum recommended requirements necessary for the design and construction of new buildings and other structures to resist earthquake ground motions throughout the United States. The intent of these provisions is to provide reasonable assurance of seismic performance that will:

1. Avoid serious injury and life loss,
2. Avoid loss of function in critical facilities, and
3. Minimize structural and nonstructural repair costs where practical to do so.

These objectives are addressed by seeking to avoid structural collapse in very rare, extreme ground shaking and by seeking to provide reasonable control of damage to structural and nonstructural systems that could lead to injury and economic or functionality losses for more moderate and frequent ground shaking. These design requirements include minimum lateral strength and stiffness for structural systems and guidance for anchoring, bracing, and accommodation of structural drift for nonstructural systems.

Occupancy Category III or IV structures intended to provide enhanced safety and functionality are required to have more strength than Occupancy Category I or II structures in an effort to reduce damage to the structural system. Allowable drifts are reduced to control damage to building components connected to multiple floor levels. Nonstructural system performance is enhanced by strengthening the anchorage and bracing requirements, and important equipment must be shown to be functional after being shaken.

The degree to which these goals can be achieved depends on a number of factors including structural framing type, building configuration, materials, as-built details, and overall quality of design. In addition, large uncertainties as to the intensity and duration of shaking and the possibility of unfavorable response of a small subset of buildings or other structures may prevent full realization of the intent.

1.2 REFERENCE DOCUMENT

Design for seismic resistance of structural elements including foundation elements and nonstructural components shall conform to the requirements of ASCE/SEI 7-05, *Minimum Design Loads for Buildings and Other Structures*, including Supplements No. 1 and No. 2 (referred to hereinafter as ASCE/SEI 7-05), as modified herein.¹

COMMENTARY TO SECTIONS 1.1 AND 1.2

The primary intent of the *NEHRP Recommended Seismic Provisions for New Buildings and Other Structures* is to prevent, for typical buildings and structures, serious injury and life loss caused by damage from earthquake ground shaking. Most earthquake injuries and deaths are caused by structural collapse; therefore, the major thrust of the *Provisions* is to prevent collapse for very rare, intense ground motion, termed the maximum considered earthquake (MCE) ground motion.² The intent remains the same in the 2009 *Provisions*; however, the prevention of collapse is redefined in terms of risk-targeted maximum considered earthquake (MCE_R) ground motions. This change is explained fully in the commentary to the Part 1 modification to ASCE/SEI 7-05 Section 11.2.

Falling exterior walls and cladding and falling interior ceilings, light fixtures, pipes, equipment, and other nonstructural components also cause deaths and injuries. The *Provisions* minimizes this risk using requirements for anchoring and bracing nonstructural components, although this level of protection generally is aimed at ground motions less severe than the MCE_R ground motion. This anchoring and bracing of nonstructural systems coupled with reasonable limitations on differential movement between floors (i.e., story drift limits) also serve to control damage that may be costly to repair or that would result in lengthy building closures, particularly for moderate shaking levels.

¹ Supplement No. 2 of the standard is available for download at <http://content.seinstitute.org/files/pdf/SupplementNo2ofthe2005EditionofASCE7.pdf>.

² The derivation of MCE ground motion was described in detail in Commentary Appendix A of the 2003 *NEHRP Recommended Provisions* (FEMA 450-2), and this appendix, "Development of Maximum Considered Earthquake Ground Motion Maps Figures 3.3-1 through 3.3-14," can be downloaded from <http://www.nibs.org/index.php/bssc/publications/fema450nehrp2003/>.

Stricter story drift limits can further limit damage to components connected to more than one floor (e.g., walls, cladding and stairways) but, at the same time, can create higher acceleration levels in the building that could increase damage to nonstructural components braced or anchored to a single floor (e.g., ceilings, light fixtures, and pipes). Achieving an optimum balance between the cost and performance of the structural system and the effect of structural stiffness on performance of the nonstructural systems is impossible using the prescriptive rules of a building code, particularly given the variety of structural systems used in the United States.

Buildings deemed to have higher importance due to hazardous contents or critical occupancy are assigned to higher Occupancy Categories (see ASCE/SEI 7-05 Table 1-1). The damage level in these buildings is intended to be reduced by decreasing nonlinear demand using an importance factor, I , to reduce the response modification coefficient, R . The resulting increased strength will reduce structural damage, or increase reliability of acceptable performance, for a given level of shaking. Some authorities having jurisdiction subject the design and construction of such buildings to a higher level of scrutiny.

The performance of critical occupancy structures in past earthquakes indicates that the increase in the importance factor controls structural damage in moderate shaking. In strong shaking associated with the design level of two-thirds the maximum considered earthquake or higher, the values of I have not been well tested for their effect on either functionality for critical buildings or increased reliability of life safety protection for high occupancy buildings.

The importance factor also increases the design anchorage and bracing load for nonstructural systems, which should increase the reliability of their staying in place and, thus, remaining undamaged. In addition, certain critical equipment must remain operable after strong shaking. Experience data show that some nonstructural components will remain functional if they stay in position, but other components will require testing to show that they will function following strong shaking. The emphasis to date has been on the seismic qualification of individual components. However, the nonstructural systems of many buildings are, in reality, complex networks that can be shut down by a single failure. For example, a break in a pressurized pipe can flood part or all of a building forcing it to close, and failure of the anchorage (or internal workings) of a battery, day tank, fuel lines, muffler, or main engine can shut down an emergency generator. Therefore, the special regulations for seismic protection of nonstructural systems represent a rational approach to achieving performance appropriate for the various occupancies, but experience data to confirm their adequacy are lacking.

When the hazard definition for design was changed from motion with a 2 percent chance of exceedance in 50 years to the 1 percent chance of collapse in 50 years, the primary intended performance was retained. The design basis ground motion is still two-thirds of the risk-targeted maximum considered earthquake (MCE_R) ground motion. The increase in the importance factor is intended to ensure a lower probability of collapse for the performance of higher occupancy and critical buildings.

The *Provisions* requirements are not intended to prevent damage due to earth slides (such as those that occurred in Anchorage, Alaska) or tsunamis (such as occurred in Hilo, Hawaii, and the Indian Ocean). They provide only for required resistance to earthquake ground shaking without significant settlement, slides, subsidence, or faulting in the immediate vicinity of the structure. In most cases, practical engineering solutions are available to resist other potential earthquake hazards, but they must be developed on a case-by-case basis.

Although the *Provisions* sets the minimum performance goals described in Section 1.1, earthquake performance of buildings and other structures is highly variable. The characteristics of the shaking itself are highly uncertain and even different sets of motions defined to qualify as maximum considered earthquake ground motions can result in significantly different responses. Additional uncertainty is created by the wide variety of systems and configurations allowed under the regulations as well as by the various interpretations and implementation practices of individual designers. Thus, a small percentage of buildings designed to the requirements of the *Provisions* may not meet the performance intent when exposed to earthquake ground motions. The commentary the *Tentative Provisions for the Development of Seismic Regulations for Buildings* (Applied Technology Council, 1978), upon which the first edition of the *NEHRP Recommended Provisions* (1985) was based, suggested a less than 1 percent chance of collapse in a 50-year period for a building designed using the tentative requirements. More recent studies (e.g., *Quantification of Building Seismic Performance Factors*, FEMA P-695, 2009) suggest a 10 percent chance of collapse with shaking at the maximum considered earthquake level, which is roughly equivalent to the 1978 estimations.

1.3 MODIFICATIONS TO ASCE/SEI 7-05

With only a few exceptions (such as the changes to Table 12.2-1 shown in underline and strikeout), modifications are presented as replacements for existing sections of ASCE/SEI 7-05 or as new sections to be added to the standard. Commentary, if any, to the modifications that appear in the remainder of this part of the 2009 Provisions is presented at the end of each chapter of modifications. Commentary to the seismic chapters (Chapters 11 through 22) of the unmodified reference document itself, ASCE/SEI 7-05, is presented in Part 2 of the 2009 Provisions.

Modifications to Chapter 11, Seismic Design Criteria

Replace with the following:

SECTION 11.1.2, SCOPE

11.1.2 Scope. Every structure, and portion thereof, including nonstructural components, shall be designed and constructed to resist the effects of earthquake motions as prescribed by the seismic requirements of this standard. Certain nonbuilding structures, as described in Chapter 15, are also within the scope and shall be designed and constructed in accordance with the requirements for Chapter 15. Requirements concerning alterations, additions, and change of use are set forth in Appendix 11B. Existing structures and alterations to existing structures need only comply with the seismic requirements of this standard where required by Appendix 11B. The following structures are exempt from the seismic requirements of this standard:

1. Detached one- and two-family dwellings that are located where the mapped, short period, spectral response acceleration parameter, S_S , is less than 0.4 or where the Seismic Design Category determined in accordance with Section 11.6 is A, B or C.
2. Dwellings of wood-frame construction satisfying the limitations of and constructed in accordance with the *International Residential Code*.
3. Buildings of wood-frame construction satisfying the limitations of and constructed in accordance with Section 2308 of the *International Building Code*.
4. Agricultural storage structures that are intended only for incidental human occupancy.
5. Structures that require special consideration of their response characteristics and environment that are not addressed in Chapter 15 and for which other regulations provide seismic criteria, such as vehicular bridges, electrical transmission towers, hydraulic structures, buried utility lines and their appurtenances, and nuclear reactors.

SECTION 11.2, DEFINITIONS

Change the definition for “Maximum Considered Earthquake (MCE) Ground Motion” to:

RISK-TARGETED MAXIMUM CONSIDERED EARTHQUAKE (MCE_R) GROUND MOTION: The most severe earthquake effects considered by this standard as defined in Section 11.4.

Add the following new definition:

MAXIMUM CONSIDERED EARTHQUAKE GEOMETRIC MEAN PEAK GROUND ACCELERATION (PGA_M): The most severe earthquake effects considered for liquefaction as defined in Section 11.8.

SECTION 11.3, NOTATION

Add the following:

- | | | |
|-----------|---|---------------------------------------------------------------------------------------------------------------------------------|
| C_R | = | risk coefficient; see Section 21.2.1.1 |
| C_{RS} | = | mapped value of the risk coefficient at short periods as defined by Figure 22-3 |
| C_{R1} | = | mapped value of the risk coefficient at a period of 1 second as defined by Figure 22-4 |
| S_{SD} | = | mapped deterministic, 5 percent damped, spectral response acceleration parameter at short periods as defined in Section 11.4.1 |
| S_{SUH} | = | mapped uniform-hazard, 5 percent damped, spectral response acceleration parameter at short periods as defined in Section 11.4.1 |

- S_{1D} = mapped deterministic, 5 percent damped, spectral response acceleration parameter at a period of 1 second as defined in Section 11.4.1
- S_{1UH} = mapped uniform-hazard, 5 percent damped, spectral response acceleration parameter at a period of 1 second as defined in Section 11.4.1

Revise the following to read as indicated:

- S_S = 5 percent damped, spectral response acceleration parameter at short periods as defined in Section 11.4.3
- S_I = spectral response acceleration parameter at a period of 1 second as defined in Section 11.4.3
- S_{aM} = the site-specific MCE_R spectral response acceleration at any period
- S_{MS} = the MCE_R , 5 percent damped, spectral response acceleration parameter at short periods adjusted for target risk and site-class effects as defined in Section 11.4.3
- S_{MI} = the MCE_R , 5 percent damped, spectral response acceleration parameter at a period of 1 second adjusted for target risk and site-class effects as defined in Section 11.4.3

SECTION 11.4, SEISMIC GROUND MOTION**Replace with the following:****11.4 SEISMIC GROUND MOTION VALUES³**

11.4.1 Mapped Acceleration Parameters and Risk Coefficients. The parameters S_{SUH} , S_{1UH} , S_{SD} , and S_{1D} shall be determined from the 0.2- and 1-second spectral response accelerations shown on Figures 22-1 and 22-2 and Figures 22-5 through 22-6, respectively, and the risk coefficients C_{RS} and C_{RI} shall be determined from Figures 22-3 and 22-4, respectively.

11.4.2 Site Class. Based on the site soil properties, the site shall be classified as either Site Class A, B, C, D, E, or F in accordance with Chapter 20. Where the soil properties are not known in sufficient detail to determine the Site Class, Site Class D shall be used unless the authority having jurisdiction or geotechnical data determines Site Class E or F soils are present at the site.

11.4.3 Site Coefficients, Risk Coefficients, and Risk-targeted Maximum Considered Earthquake (MCE_R) Spectral Response Acceleration Parameters. The spectral response acceleration for short periods (S_S), adjusted for the target risk of collapse, shall be determined as the lesser value of Equations 11.4-1 and 11.4-2:

$$S_S = C_{RS} S_{SUH} \quad (11.4-1)$$

$$S_S = S_{SD} \quad (11.4-2)$$

and the spectral response acceleration at a period of 1 second (S_I), adjusted for the target risk of collapse, shall be determined as the lesser value of Equations 11.4-3 and 11.4-4:

$$S_I = C_{RI} S_{1UH} \quad (11.4-3)$$

$$S_I = S_{1D} \quad (11.4-4)$$

where

- S_{SD} = mapped deterministic, 5 percent damped, spectral response acceleration parameter at short periods as defined in Section 11.4.1
- S_{SUH} = mapped uniform-hazard, 5 percent damped, spectral response acceleration parameter at short periods as defined in Section 11.4.1
- C_{RS} = mapped value of the risk coefficient at short periods as defined in Section 11.4.1
- S_{1D} = mapped deterministic, 5 percent damped, spectral response acceleration parameter at a period of 1 second as defined in Section 11.4.1

³ To utilize the U.S. Geological Survey's seismic design map web application to obtain ground motion values, visit <http://earthquake.usgs.gov/designmaps/usapp>. Also see the USGS introduction to the web application included on the CD that accompanies this volume.

S_{1UH} = mapped uniform-hazard, 5 percent damped, spectral response acceleration parameter at a period of 1 second as defined in Section 11.4.1

C_{R1} = mapped value of the risk coefficient at a period of 1 second as defined in Section 11.4.1

The MCE_R spectral response acceleration for short periods (S_{MS}) and at 1 second (S_{M1}), adjusted for Site Class effects and the target risk of collapse, shall be determined by Equations 11.4-5 and 11.4-6, respectively.

$$S_{MS} = F_a S_s \quad (11.4-5)$$

$$S_{M1} = F_v S_1 \quad (11.4-6)$$

where site coefficients F_a and F_v are defined in Tables 11.4-1 and 11.4-2, respectively. When the simplified design procedure of Section 12.14 is used, the value F_a shall be determined in accordance with Section 12.14.8.1, and the values of F_v , S_1 , S_{MS} , and S_{M1} need not be determined. Where S_j is less than or equal to 0.04 and S_s is less than or equal to 0.15, the structure is permitted to be assigned to Seismic Design Category A and is only required to comply with Section 11.7.

Table 11.4-1 Site Coefficient, F_a

Site Class	Spectral Response Acceleration Parameter at Short Period				
	$S_s \leq 0.25$	$S_s = 0.5$	$S_s = 0.75$	$S_s = 1.0$	$S_s \geq 1.25$
A	0.8	0.8	0.8	0.8	0.8
B	1.0	1.0	1.0	1.0	1.0
C	1.2	1.2	1.1	1.0	1.0
D	1.6	1.4	1.2	1.1	1.0
E	2.5	1.7	1.2	0.9	0.9
F	See Section 11.4.7				

Note: Use straight-line interpolation for intermediate values of S_s .

Table 11.4-2 Site Coefficient, F_v

Site Class	Spectral Response Acceleration Parameter at 1-second Period				
	$S_1 \leq 0.1$	$S_1 = 0.2$	$S_1 = 0.3$	$S_1 = 0.4$	$S_1 \geq 0.5$
A	0.8	0.8	0.8	0.8	0.8
B	1.0	1.0	1.0	1.0	1.0
C	1.7	1.6	1.5	1.4	1.3
D	2.4	2.0	1.8	1.6	1.5
E	3.5	3.2	2.8	2.4	2.4
F	See Section 11.4.7				

Note: Use straight-line interpolation for intermediate values of S_1 .

11.4.4 Design Spectral Acceleration Parameters. Design earthquake spectral response acceleration parameter at short periods, S_{DS} , and at a 1-second period, S_{D1} , shall be determined from Equations 11.4-7 and 11.4-8, respectively. Where the alternate simplified design procedure of Section 12.14 is used, the value of S_{DS} shall be determined in accordance with Section 12.14.8.1, and the value of S_{D1} need not be determined:

$$S_{DS} = \frac{2}{3} S_{MS} \quad (11.4-7)$$

$$S_{D1} = \frac{2}{3} S_{M1} \quad (11.4-8)$$

11.4.5 Design Response Spectrum. Where a design response spectrum is required by this standard and site-specific ground motion procedures are not used, the design response spectrum curve shall be developed as indicated in Figure 11.4-1 and as follows:

- For periods less than T_0 , the design spectral response acceleration, S_a , shall be taken as given by Equation 11.4-9:

$$S_a = S_{DS} \left(0.4 + 0.6 \frac{T}{T_0} \right) \quad (11.4-9)$$

- For periods greater than or equal to T_0 and less than or equal to T_S , the design spectral response acceleration, S_a , shall be taken equal to S_{DS} .

3. For periods greater than T_S , and less than or equal to T_L , the design spectral response acceleration, S_a , shall be taken as given by Equation 11.4-10:

$$S_a = \frac{S_{D1}}{T} \tag{11.4-10}$$

4. For periods greater than T_L , S_a shall be taken as given by Equation 11.4-11:

$$S_a = \frac{S_{D1}T_L}{T^2} \tag{11.4-11}$$

where

- S_{DS} = the design spectral response acceleration parameter at short periods;
- S_{D1} = the design spectral response acceleration parameter at 1-second period;
- T = the fundamental period of the structure, seconds;
- T_0 = $0.2 S_{D1}/S_{DS}$;
- T_S = S_{D1}/S_{DS} ; and
- T_L = long-period transition period (seconds) shown in Figure 22-7.

11.4.6 MCE_R Response Spectrum. Where a MCE_R response spectrum is required, it shall be determined by multiplying the design response spectrum by 1.5.

11.4.7 Site-Specific Ground Motion Procedures. The site-specific ground motion procedures set forth in Chapter 21 are permitted to be used to determine ground motions for any structure. A site response analysis shall be performed in accordance with Section 21.1 for structures on Site Class F sites, unless the exception to Section 20.3.1 is applicable. For seismically isolated structures and for structures with damping systems on sites with S_1 greater than or equal to 0.6, a ground motion hazard analysis shall be performed in accordance with Section 21.2.

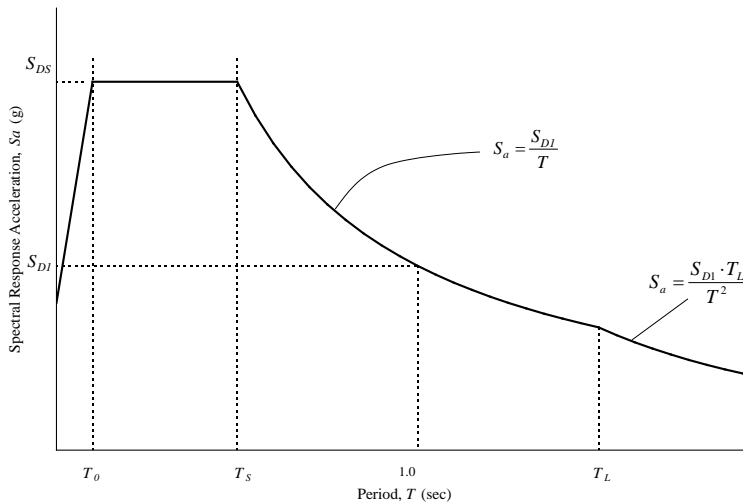

Figure 11.4-1 Design response spectrum.

SECTION 11.8, GEOLOGIC HAZARDS AND GEOTECHNICAL INVESTIGATION

Replace with the following:

11.8 Geologic Hazards and Geotechnical Investigation

11.8.1 Site Limitation for Seismic Design Categories E and F. A structure assigned to Seismic Design Category E or F shall not be located where there is a known potential for an active fault to cause rupture of the ground surface at the structure.

11.8.2 Geotechnical Investigation Report Requirements for Seismic Design Categories C through F. A geotechnical investigation report shall be provided for a structure assigned to Seismic Design Category C, D, E, or F in

accordance with this section. An investigation shall be conducted and a report shall be submitted that shall include an evaluation of the following potential geologic and seismic hazards:

1. Slope instability;
2. Liquefaction;
3. Total and differential settlement; and
4. Surface displacement due to faulting or seismic-induced lateral spreading or lateral flow.

The report shall contain recommendations for appropriate foundation designs or other measures to mitigate the effects of the above hazards.

EXCEPTION: Where deemed appropriate by the authority having jurisdiction, a site-specific geotechnical report is not required when prior evaluations of nearby sites with similar soil conditions provide sufficient direction relative to the proposed construction.

11.8.3 Additional Geotechnical Investigation Report Requirements for Seismic Design Categories D through F.

The geotechnical investigation report for a structure assigned to Seismic Design Category D, E, or F shall include:

1. The determination of dynamic seismic lateral earth pressures on basement and retaining walls due to design earthquake ground motions.
2. The potential for liquefaction and soil strength loss evaluated for site peak ground acceleration, earthquake magnitude, and source characteristics consistent with the maximum considered earthquake geometric mean peak ground accelerations. Peak ground acceleration shall be determined based on either: (a) a site-specific study taking into account soil amplification effects as specified in Section 11.4.7 or (b) the peak ground acceleration, PGA_M , from Equation 11.8-1:

$$PGA_M = F_{PGA} PGA \quad (11.8-1)$$

where

PGA_M = maximum considered earthquake geometric mean peak ground acceleration adjusted for Site Class effects;

PGA = mapped maximum considered earthquake geometric mean peak ground acceleration shown in Figures 22-8 through 22-11; and

F_{PGA} = site coefficient from Table 11.8-1.

3. Assessment of potential consequences of liquefaction and soil strength loss as computed in Item 2, including estimation of total and differential settlement, lateral soil movement, lateral soil loads on foundations, reduction in foundation soil-bearing capacity and lateral soil reaction, soil downdrag and reduction in axial and lateral soil reaction for pile foundations, increases in soil lateral pressures on retaining walls, and flotation of buried structures.
4. Discussion of mitigation measures such as selection of appropriate foundation type and depths, selection of appropriate structural systems to accommodate anticipated displacements and forces, ground stabilization, or any combination of these measures and how they shall be considered in the design of the structure.

Table 11.8-1 Site Coefficient F_{PGA}

Site Class	Mapped MCE Geometric Mean Peak Ground Acceleration, PGA				
	PGA ≤ 0.1	PGA = 0.2	PGA = 0.3	PGA = 0.4	PGA ≥ 0.5
A	0.8	0.8	0.8	0.8	0.8
B	1.0	1.0	1.0	1.0	1.0
C	1.2	1.2	1.1	1.0	1.0
D	1.6	1.4	1.2	1.1	1.0
E	2.5	1.7	1.2	0.9	0.9
F	See Section 11.4.7				

Note: Use straight-line interpolation for intermediate values of PGA.

Commentary to Chapter 11 Modifications

COMMENTARY TO SECTION 11.1.2

C11.1.2 Scope. The scope statement establishes in general terms the applicability of the standard as a base of reference. Certain structures are exempt and need not comply. The reasons for each are described below.

Note that it is not acceptable to use a combination of *International Building Code (IBC)* and *International Residential Code (IRC)* conventional construction provisions. Conventional requirements of either the IBC or the IRC can be combined with engineered design of elements in accordance with IBC engineered design requirements. Elements designed using the IBC engineered design requirements are not exempt from the seismic requirements of ASCE/SEI 7.

Exemption 1 – Detached one- and two-family dwellings in Seismic Design Categories A, B, and C, along with those located where $S_s < 0.4g$, are exempt because they represent low seismic risks.

Exemption 2 – This exemption recognizes that the wood-frame seismic design requirements of the *International Residential Code (IRC)* substantially meet the intent of conventional construction (wood-frame) provisions included in the *NEHRP Recommended Seismic Provisions* through the 2003 Edition.

Exemption 3 – This exemption recognizes that wood-frame seismic design requirements of *International Building Code (IBC)* Section 2308 substantially meet the intent of conventional construction (wood-frame) provisions included in the *NEHRP Recommended Seismic Provisions* through the 2003 Edition.

Exemption 4 – Agricultural storage structures generally are exempt from most code requirements because of the exceptionally low risk to life involved.

Exemption 5 – Bridges, transmission towers, nuclear reactors, and other structures with special configurations and uses are not covered because regulations developed to apply to buildings and building-like structures do not adequately address their design and performance issues.

The standard is not retroactive and usually applies to existing structures only where there is an addition, change of use, or alteration. Minimum acceptable seismic resistance of existing buildings is a policy issue normally set by the authority having jurisdiction. Appendix 11B of the standard contains rules of application for basic conditions. ASCE 31, *Seismic Evaluation of Buildings*, and ASCE 41, *Seismic Rehabilitation of Existing Buildings*, are available for technical guidance but do not contain policy recommendations. The International Code Council includes a chapter in the IBC to control the alteration, repair, addition, and change of occupancy of existing buildings and also maintains the *International Existing Building Code (IEBC)* and an associated commentary.

COMMENTARY TO SECTION 11.2

C11.2 DEFINITIONS

Renaming the maximum considered earthquake (MCE) ground motions as the risk-targeted maximum considered earthquake (MCE_R) ground motions is an editorial change recommended by the BSSC's Provisions Update Committee and accepted by the BSSC's Board. The MCE_R ground motions are based on the 2008 USGS seismic hazard maps and also incorporate three technical changes to ASCE/SEI 7-05:

1. Use of risk-targeted ground motions,
2. Use of maximum direction ground motions, and
3. Use of near-source 84th percentile ground motions.

Reasons for each of the three technical changes are included in the commentary that accompanies the modifications to Chapter 21.

COMMENTARY TO SECTIONS 11.4.3 AND 11.4.4

C11.4.3 Site Coefficients, Risk Coefficients, and Risk-targeted Maximum Considered Earthquake (MCE_R) Spectral Response Acceleration Parameters. The following illustrates the process of developing MCE_R response spectral accelerations using the formulas and maps of Section 11.4.3 and Chapter 22, respectively, and provides a summary of design ground motions for 34 city sites in regions of the United States of greatest seismic risk. Additional information and

references explaining the differences from the MCE ground motions in ASCE/SEI 7-05 are included in the commentary to Chapter 21.

Illustration of the Development of MCE_R Spectral Response Acceleration Using Section 11.4.3 Equations and Chapter 22 Uniform-Hazard, Risk Coefficient, and Deterministic Maps.

The formulas of Section 11.4.3 (and the associated uniform-hazard, risk coefficient, and deterministic maps of Chapter 22) are intended to add transparency to the development of MCE_R ground motions. The development of MCE_R ground motions is explained in Section 21.2 and its commentary as part of the site-specific ground motion procedures for seismic design. As will be illustrated, the formulas (and maps) add transparency by emulating the site-specific procedure. A cost of this transparency is the added complexity of more formulas (and maps). However, a USGS website similar to the USGS Java ground motion parameter calculator automates use of the proposed formulas (and maps): <http://earthquake.usgs.gov/designmaps/usapp>.

The three steps that the website implements are as follows:

Step 1 – Adjust uniform-hazard ground motions (Site Class B) for target risk of collapse

As illustrated in the top row of Figure C11.4-1, the first step is to obtain the mapped uniform-hazard (2 percent-in-50-years probability of exceedance) spectral response acceleration for short periods (S_{SUH}) from Figure 22-1 and for a period of 1 second (S_{1UH}) from Figure 22-2, and then to multiply these values by the corresponding mapped risk coefficients (C_{RS} and C_{R1}) from Figures 22-3 and 22-4, respectively. This step is expressed in Equations 11.4-1 for the short periods and 11.4-3 for the 1-second period and is consistent with Section 21.2.1 of the site-specific procedure in Chapter 21. The resulting spectral response accelerations, $C_{RS}S_{SUH}$ and $C_{R1}S_{1UH}$, are referred to as probabilistic ground motions. Figure C11.4-1 illustrates this for the 1-second period only using small maps of the conterminous United States that depict S_{1UH} , C_{R1} , and $C_{R1}S_{1UH}$.

The reasons for using 2 percent-in-50-years (uniform-hazard) spectral response accelerations, which were the basis for the probabilistic portions of the MCE ground motion maps in ASCE/SEI 7-05, are explained in the commentary of the 2003 *NEHRP Recommended Provisions*. As explained below in the Chapter 21 commentary, the uniform-hazard maps (Figures 22-1 and 22-2) represent the spectral response acceleration in the maximum direction, which are larger than the *geometric mean* spectral response acceleration maps developed by the USGS by factors of 1.1 for the short periods and 1.3 for the 1-second period. The risk coefficients adjust these uniform-hazard (2 percent-in-50-years) spectral response accelerations to achieve building designs with 1 percent probability of collapse in 50 years (i.e., uniform risk), as explained below in the Chapter 21 commentary.

Step 2 – Take minimum of probabilistic and deterministic ground motions (Site Class B)

As illustrated in the middle row of Figure C11.4-1, the second step in the development of MCE_R ground motions is to obtain the mapped deterministic spectral response acceleration for short periods (S_{SD}) from Figure 22-5 and for a period of 1 second (S_{1D}) from Figure 22-6, and then to take the minimum of each of these values (expressed in Equations 11.4-2 and 11.4-4, respectively) and the corresponding value resulting from Step 1 (i.e., those expressed in Equations 11.4-1 and 11.4-3, respectively). This step is consistent with Sections 21.2.2 (“Deterministic Ground Motions”) and 21.2.3 (“Site Specific MCE_R ”) of the site-specific procedure in Chapter 21. The resulting spectral response accelerations are denoted S_S for the short periods and S_1 for the 1-second period. Figure C11.4-1 illustrates this for the 1-second period only using small maps of the conterminous United States that depict $C_{R1}S_{1UH}$, S_{1D} , and S_1 .

The reasons for using the minimum of probabilistic and deterministic spectral response accelerations, which was done previously (but not transparently) in developing the MCE ground motions maps in ASCE/SEI 7-05, are explained in the commentary of the 2003 *NEHRP Recommended Provisions*. In brief, deterministic ground motions provide a reasonable and practical upper-bound to design ground motions, but their use implies a somewhat higher level of collapse risk than the 1 percent probability of collapse in 50 years associated with probabilistic (risk-targeted) ground motions. In general, deterministic ground motions govern only at sites near active sources in regions of high seismicity.

As defined in ASCE/SEI 7-05 Section 21.2.2, the deterministic spectral response accelerations (for Site Class B) shall not be taken as lower than 1.5g for the short periods and 0.6g for the 1-second period; hence, the ground motions on the proposed deterministic maps (Figures 22-5 and 22-6) are no lower than these values. Otherwise the ground motions on the proposed deterministic maps are 180 percent (as opposed to 150 percent in ASCE/SEI 7-05) of median spectral response accelerations, for reasons explained below in the section entitled “Deterministic Ground Motions – 84th Percentile.” Like the proposed uniform-hazard maps used in Step 1, the proposed deterministic maps represent the spectral response acceleration in the maximum direction.

Step 3 – Adjust Site Class B ground motions for site condition (e.g., Site Class D)

As illustrated in the bottom row of Figure C11.4-1, the third step is to multiply the spectral response accelerations resulting from Step 2 (S_S and S_1) by the corresponding site coefficients (F_a and F_v) from Tables 11.4-1 and 11.4-2, respectively. This step is expressed in Equation 11.4-5 for the short periods and 11.4-6 for the 1-second period, where the resulting ground motions are named risk-targeted maximum considered earthquake (MCE_R) spectral response accelerations and are denoted S_{MS} and S_{M1} , respectively. Figure C11.4-1 illustrates the step for the 1-second period only using a small map of the conterminous United States that depicts S_1 , an abbreviated version of Table 11.4-2, and another small map that depicts S_{M1} .

This step is the same as that in ASCE/SEI 7-05 Section 11.4.3, except that the resulting MCE spectral response accelerations (S_{MS} and S_{M1}) have been renamed MCE_R spectral response accelerations.

Figures C11.4-2 and C11.4-3 are maps of the United States and California, respectively, showing values of the MCE_R 1-second spectral response acceleration parameter, S_{M1} , and associated regions of Seismic Design Category, assuming Site Class D conditions. These maps illustrate MCE_R ground motions resulting from the three-step process described above for the 1-second period only.

The design ground motions are 2/3 of these MCE_R ground motions as calculated using Equations 11.4-7 and 11.4-8.

Summary of Design Ground Motions – 34 United States Cities

Example values of the design ground motions that incorporate both USGS updates to uniform-hazard values (and hazard functions), including the new NGA relations, and the three technical changes mentioned above, are shown next. For comparison, values of design ground motions of the current standard (ASCE/SEI 7-05) and, for California sites, values of design ground motions of the 2001 *California Building Code* (CBC) are given. In all cases, example values are based on design ground motions, representative of Site Class D conditions (i.e., default site class).

Table C11.4-1 lists the 34 city sites by region, the county (or counties) and associated populations they represent, and the latitude and longitude of the specific location of the city site. Typically, each city is the largest city of the county or metropolitan statistical area (MSA) of interest. The exception is Los Angeles County which has four city sites due to its large geographical area and associated risk. The specific location (latitude and longitude) of city sites is important for sites in high seismic regions (i.e., near an active source) since ground motions can vary greatly over relatively small distances. Example sites are selected to be coincident with the location of the hazard grid point nearest the center of the city of interest. Hazard grid points are the discrete locations at which the USGS calculates values of probabilistic and deterministic ground motions (and risk coefficients). At the time that these examples were developed, ground motions were available (from the USGS) only for these discrete locations; however, final maps and database tools such as the USGS online ground motion parameter calculator also provide values of ground motions at intermediate locations.

Table C11.4-2 provides values of short-period spectral acceleration, S_{DS} , and Table C11.4-3 provides values of 1-second spectral acceleration, S_{D1} , for each of the 34 city sites of Table C11.4-1. Spectral acceleration values and Seismic Design Category (SDC) are given for both ASCE/SEI 7-05 provisions and changes put forth in these provisions (2009 *Provisions*). For California city sites, these tables also provide the corresponding values of seismic coefficients ($2.5C_a$, at short periods, and, C_v , at 1 second) of the 2001 *California Building Code* (1997 Uniform Building Code or UBC). Weighted mean values of spectral acceleration (and seismic coefficients) are calculated for each region considering the population associated with each city site in Tables 11.4-2 and 11.4-3.

The following observations are made by comparing the design ground motions of these *Provisions* with those of ASCE/SEI 7-05 and the design coefficients of the 2001 *California Building Code* (CBC):

1. On a regional basis, the changes to ASCE/SEI 7-05 put forth in these *Provisions* result in only a slight increase or decrease in design ground motions, on average. Notable exceptions are short-period ground motions in the central and eastern United States (CEUS) for which the changes reduce design values and for certain city sites (e.g., St. Louis, Chicago, and New York) where the changes also lower the Seismic Design Category.
2. In the western region (WUS), the changes to ASCE/SEI 7-05 put forth in these *Provisions* result in a modest increase, or decrease, in design ground motions (plus or minus 10 percent), and generally lower seismic design values from those of 2001 CBC (1997 UBC).
3. For certain city sites (e.g., San Bernardino and San Diego), the changes to ASCE/SEI 7-05 put forth in these *Provisions* result in a substantial increase, or decrease, in design ground motions due primarily to changes in underlying updated USGS hazard functions.

Step 1 – Adjust uniform-hazard ground motions (Site Class B) for target risk of collapse

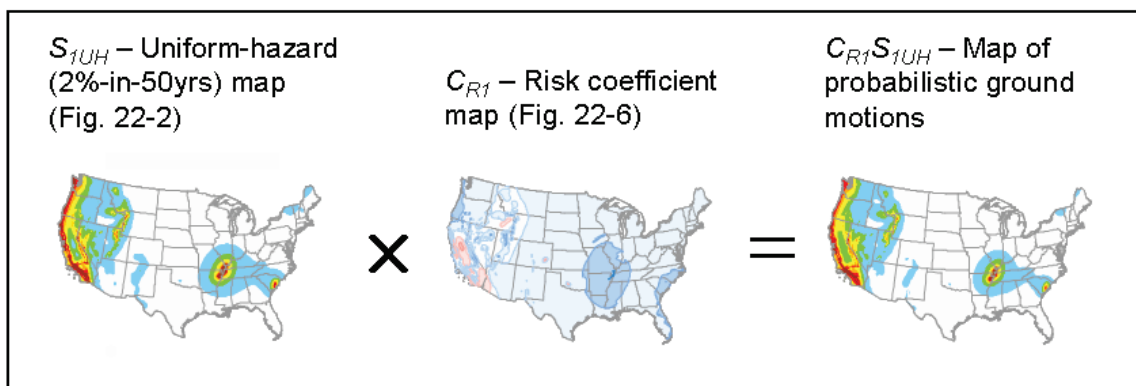

Step 2 – Take minimum of probabilistic and deterministic ground motions (Site Class B)

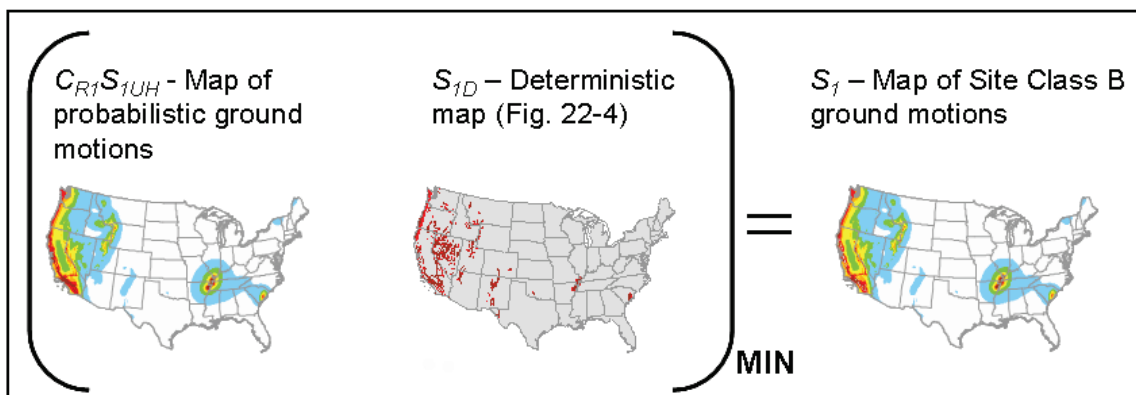

Step 3 – Adjust Site Class B ground motions for site conditions (e.g., Site Class D)

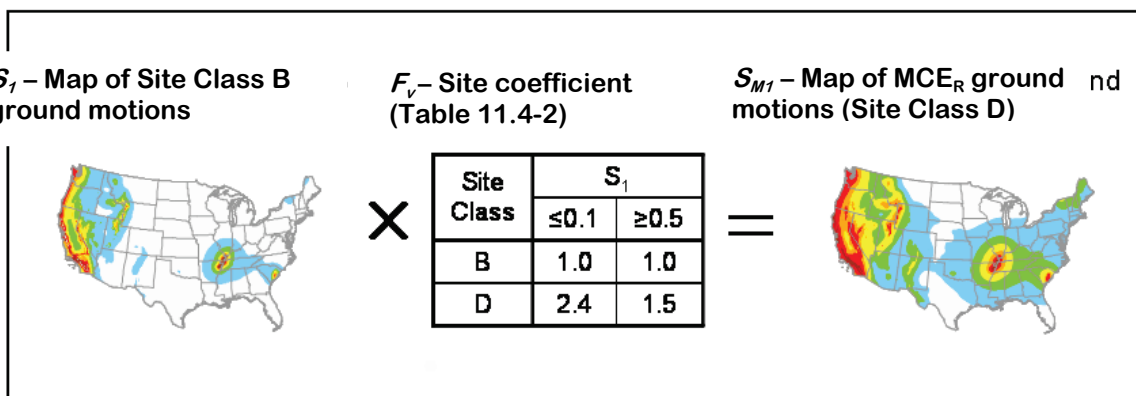

Figure C11.4-1 Illustration of process for developing 1-second MCE_R Site Class D ground motions using formulas of Section 11.4.3 and associated mapped values of ground motions and risk coefficients of Chapter 22.

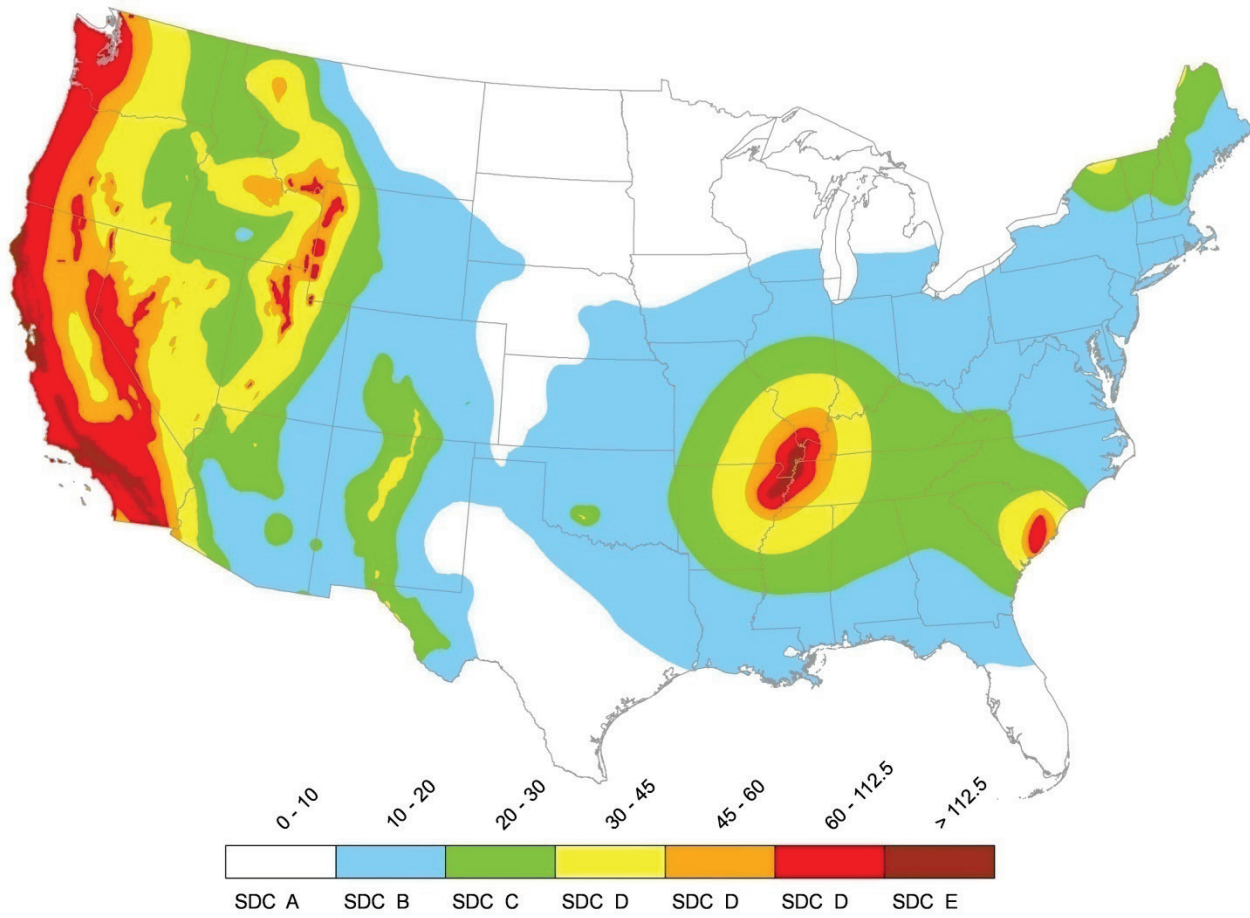

Figure C11.4-2 Map illustrating values of the MCE_R 1-second spectral response acceleration parameter, S_{M1} (%g), and associated regions of Seismic Design Category, assuming Site Class D conditions.

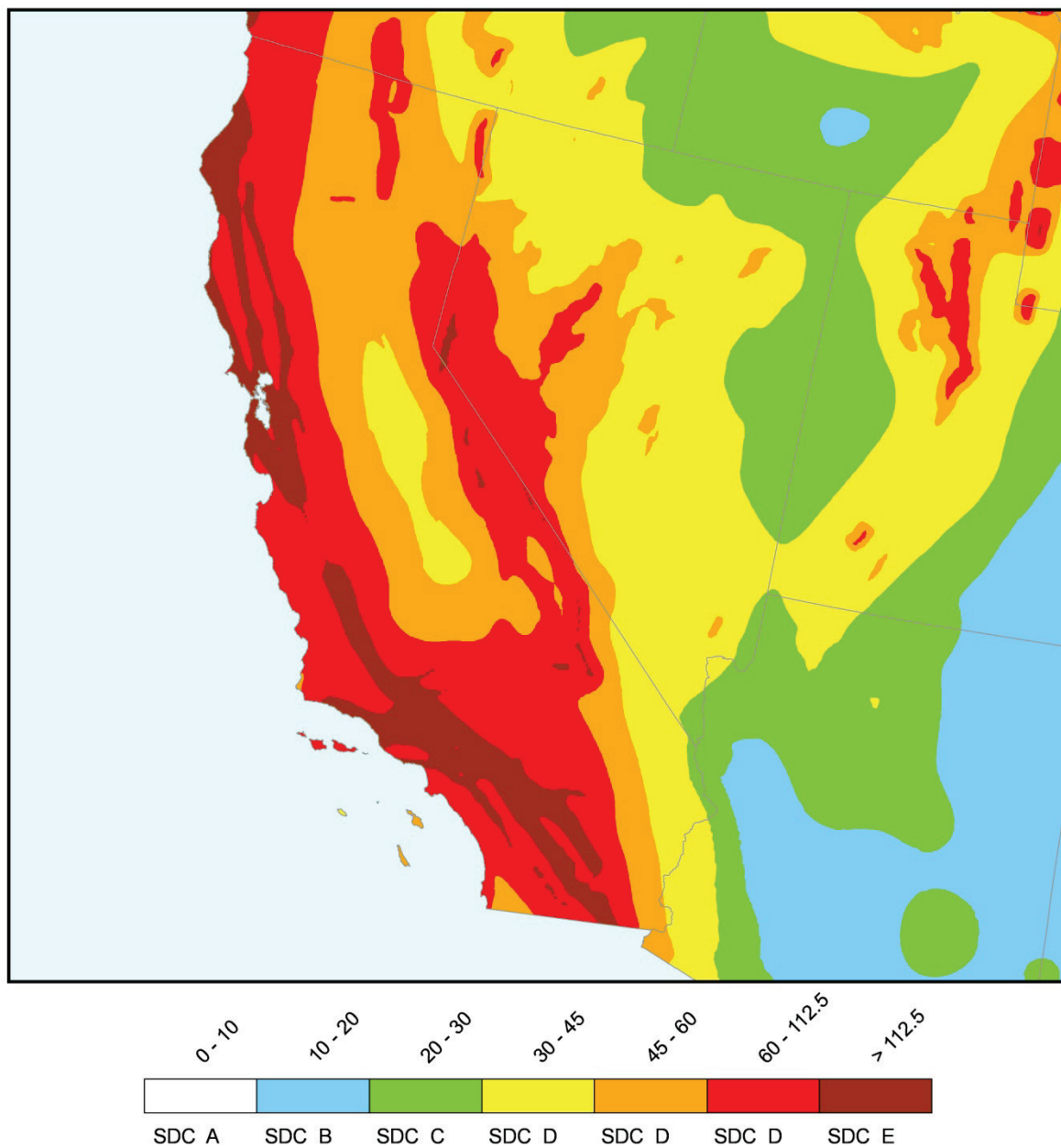

Figure C11.4-3 Map illustrating values of the MCE_R 1-second spectral response acceleration parameter, S_{M1} (%g), and associated regions of Seismic Design Category, assuming Site Class D conditions, for California sites.

Table C11.4-1 Thirty-Four Cities, Site Locations (Latitude and Longitude), and Associated Counties and Populations At Risk for Which Values of Ground Motions Are Provided

Region	City and Location of Site			County or Metropolitan Statistical Area	
	Name	Latitude	Longitude	Name	Population
Southern California	Los Angeles	34.05	-118.25	Los Angeles	9,948,081
	Century City	34.05	-118.40		
	Northridge	34.20	-118.55		
	Long Beach	33.80	-118.20		
	Irvine	33.65	-117.80	Orange	3,002,048
	Riverside	33.95	-117.40	Riverside	2,026,803
	San Bernardino	34.10	-117.30	San Bernardino	1,999,332
	San Luis Obispo	35.30	-120.65	San Luis Obispo	257,005
	San Diego	32.70	-117.15	San Diego	2,941,454
	Santa Barbara	34.45	-119.70	Santa Barbara	400,335
	Ventura	34.30	-119.30	Ventura	799,720
	Total Population - S. California			22,349,098	Population - 8 Counties
Northern California	Oakland	37.80	-122.25	Alameda	1,502,759
	Concord	37.95	-122.00	Contra Costa	955,810
	Monterey	36.60	-121.90	Monterey	421,333
	Sacramento	38.60	-121.50	Sacramento	1,233,449
	San Francisco	37.75	-122.40	San Francisco	776,733
	San Mateo	37.55	-122.30	San Mateo	741,444
	San Jose	37.35	-121.90	Santa Clara	1,802,328
	Santa Cruz	36.95	-122.05	Santa Cruz	275,359
	Vallejo	38.10	-122.25	Solano	423,473
	Santa Rosa	38.45	-122.70	Sonoma	489,290
	Total Population - N. California			14,108,451	Population - 10 Counties
Pacific Northwest	Seattle	47.60	-122.30	King WA	1,826,732
	Tacoma	47.25	-122.45	Pierce WA	766,878
	Everett	48.00	-122.20	Snohomish WA	669,887
	Portland	45.50	-122.65	Portland Metro OR (3)	1,523,690
	Total Population - OR and WA			10,096,556	Population - 6 Counties
Other WUS	Salt Lake City	40.75	-111.90	Salt Lake UT	978,701
	Boise	43.60	-116.20	Ada/Canyon ID (2)	532,337
	Reno	39.55	-119.80	Washoe NV	396,428
	Las Vegas	36.20	-115.15	Clarke NV	1,777,539
	Total Population - ID/UT/NV			6,512,057	Population - 5 Counties
CEUS	St. Louis	38.60	-90.20	St. Louis MSA (16)	2,786,728
	Memphis	35.15	-90.05	Memphis MSA (8)	1,269,108
	Charleston	32.80	-79.95	Charleston MSA (3)	603,178
	Chicago	41.85	-87.65	Chicago MSA (7)	9,505,748
	New York	40.75	-74.00	New York MSA (23)	18,747,320
	Total Population - MO/TN/SC/IL/NY			48,340,918	Population - 57 Counties

Table C11.4-2 Comparison of Values of the Short-Period Design Ground Motion Parameter (S_{DS}) and Corresponding Seismic Design Category (SDC) Put Forth in These Provisions with ASCE/SEI 7-05 and 1997 UBC Values for 34 City Site Locations (Assuming Default Site Class D)

Region	City (Site Location)	2001 CBC (1997 UBC)		Current - ASCE 7-05		2009 Provisions	
		Zone	$2.5 \cdot C_a$	SDC	S_{DS} (g)	SDC	S_{DS} (g)
Southern California	Los Angeles	4	1.10	D	1.44	E	1.60
	Century City	4 (NF)	1.32	D	1.22	E	1.44
	Northridge	4	1.10	D	1.09	D	1.13
	Long Beach	4 (NF)	1.43	D	1.20	D	1.10
	Irvine	4	1.10	D	1.00	D	1.03
	Riverside	4	1.10	D	1.00	D	1.00
	San Bernardino	4 (NF)	1.32	D	1.13	E	1.58
	San Luis Obispo	4	1.10	D	0.83	D	0.78
	San Diego	4 (NF)	1.43	D	1.07	D	0.84
	Santa Barbara	4 (NF)	1.43	E	1.38	E	1.89
	Ventura	4 (NF)	1.43	E	1.64	E	1.59
	Weighted Mean		1.25		1.16		1.22
Northern California	Oakland	4 (NF)	1.43	D	1.06	D	1.24
	Concord	4	1.10	D	1.23	E	1.38
	Monterey	4	1.10	D	0.97	D	1.02
	Sacramento	3	0.90	D	0.52	D	0.57
	San Francisco	4	1.10	D	1.00	D	1.00
	San Mateo	4 (NF)	1.28	E	1.17	D	1.23
	San Jose	4	1.10	D	1.00	D	1.00
	Santa Cruz	4	1.10	D	1.00	D	1.01
	Vallejo	4 (NF)	1.19	D	1.00	D	1.00
	Santa Rosa	4 (NF)	1.65	E	1.37	E	1.67
	Weighted Mean		1.18		1.00		1.08
Pacific Northwest	Seattle			D	0.97	D	0.91
	Tacoma			D	0.82	D	0.86
	Everett			D	0.80	D	0.85
	Portland			D	0.73	D	0.72
	Weighted Mean				0.84		0.83
Other WUS	Salt Lake City			D	1.15	D	1.03
	Boise			B	0.32	B	0.32
	Reno			D	1.00	D	1.00
	Las Vegas			D	0.51	C	0.46
	Weighted Mean				0.70		0.65
CEUS	St. Louis			D	0.52	C	0.42
	Memphis			D	0.93	D	0.74
	Charleston			D	1.01	D	0.80
	Chicago			B	0.18	A	0.14
	New York			C	0.37	B	0.29
	Weighted Mean				0.36		0.29

Table C11.4-3 Comparison of Values of the 1-Second Period Design Ground Motion Parameter (S_{D1}) and Corresponding Seismic Design Category (SDC) Put Forth in These Provisions with ASCE/SEI 7-05 and 1997 UBC Values for 34 City Site Locations (Assuming Default Site Class D)

Region	City (Site Location)	2001 CBC (1997 UBC)		Current - ASCE 7-05		2009 Provisions	
		Zone	C_v	SDC	S_{D1} (g)	SDC	S_{D1} (g)
Southern California	Los Angeles	4 (NF)	0.72	D	0.72	E	0.84
	Century City	4 (NF)	0.93	D	0.72	E	0.80
	Northridge	4	0.64	D	0.61	D	0.60
	Long Beach	4 (NF)	1.02	D	0.70	D	0.62
	Irvine	4	0.64	D	0.53	D	0.57
	Riverside	4	0.64	D	0.60	D	0.60
	San Bernardino	4 (NF)	0.93	D	0.62	E	1.08
	San Luis Obispo	4 (NF)	0.77	D	0.48	D	0.45
	San Diego	4 (NF)	1.02	D	0.64	D	0.49
	Santa Barbara	4 (NF)	1.02	E	0.81	E	0.99
	Ventura	4 (NF)	1.02	E	0.86	E	0.90
	Weighted Mean		0.83		0.65		0.70
Northern California	Oakland	4 (NF)	1.04	D	0.60	D	0.75
	Concord	4 (NF)	0.77	D	0.65	D	0.73
	Monterey	4 (NF)	0.77	D	0.61	D	0.56
	Sacramento	3	0.54	D	0.31	D	0.35
	San Francisco	4 (NF)	0.74	D	0.68	D	0.64
	San Mateo	4 (NF)	0.95	E	0.90	E	0.86
	San Jose	4 (NF)	0.69	D	0.60	D	0.60
	Santa Cruz	4 (NF)	0.72	D	0.60	D	0.60
	Vallejo	4 (NF)	0.87	D	0.60	D	0.60
	Santa Rosa	4 (NF)	1.28	E	0.83	E	1.04
	Weighted Mean		0.81		0.61		0.65
Pacific Northwest	Seattle			D	0.49	D	0.53
	Tacoma			D	0.44	D	0.51
	Everett			D	0.43	D	0.49
	Portland			D	0.39	D	0.44
	Weighted Mean				0.44		0.49
Other WUS	Salt Lake City			D	0.70	D	0.56
	Boise			C	0.17	C	0.17
	Reno			D	0.59	D	0.52
	Las Vegas			D	0.25	D	0.24
	Weighted Mean				0.39		0.34
CEUS	St. Louis			D	0.24	D	0.24
	Memphis			D	0.42	D	0.40
	Charleston			D	0.41	D	0.41
	Chicago			B	0.10	B	0.10
	New York			B	0.11	B	0.11
	Weighted Mean				0.14		0.14

COMMENTARY TO SECTION 11.8.3

C11.8.3 Additional Geotechnical Investigation Report Requirements for Seismic Design Categories D through F. The dynamic lateral earth pressure on basement and retaining walls during the period of earthquake ground shaking is considered to be an earthquake load, E , for use in design load combinations. This dynamic earth pressure is superimposed on the pre-existing static lateral earth pressure during ground shaking. The pre-existing static lateral earth pressure is considered to be an H load.

While the dynamic seismic lateral earth pressures (Item 1) may be determined for design earthquake ground motions, taken as $2/3$ of maximum considered earthquake ground motions, the potential for liquefaction and soil strength loss and related consequences (Items 2 and 3) must be evaluated for maximum considered earthquake ground motions because they can be catastrophic to a structure.

Page intentionally left blank.

Modifications to Chapter 12, Seismic Design Requirements for Building Structures

**TABLE 12.2-1, DESIGN COEFFICIENTS AND FACTORS
FOR SEISMIC-FORCE-RESISTING SYSTEMS**

Revise as indicated (substantive changes are shaded, deletions are shown in ~~strikeout~~, and additions are underlined):

Table 12.2-1 Design Coefficients and Factors for Seismic-Force-Resisting Systems

Seismic-Force-Resisting System	ASCE/SEI 7-05 Section Where Detailing Requirements Are Specified	Response Modification Coefficient, R^a	System Overstrength Factor, Ω_0^g	Deflection Amplification Factor, C_d^b	Structural System Limitations and Building Height (ft) Limit ^c				
					Seismic Design Category				
					B	C	D ^d	E ^d	F ^e
A. BEARING WALL SYSTEMS									
1. Special reinforced concrete shear walls	14.2 and 14.2.3.6	5	2½	5	NL	NL	160	160	100
2. Ordinary reinforced concrete shear walls	14.2 and 14.2.3.4	4	2½	4	NL	NL	NP	NP	NP
3. Detailed plain concrete shear walls	14.2 and 14.2.3.2	2	2½	2	NL	NP	NP	NP	NP
4. Ordinary plain concrete shear walls	14.2 and 14.2.3.1	1½	2½	1½	NL	NP	NP	NP	NP
5. Intermediate precast shear walls	14.2 and 14.2.3.5	4	2½	4	NL	NL	40 ^k	40 ^k	40 ^k
6. Ordinary precast shear walls	14.2 and 14.2.3.3	3	2½	3	NL	NP	NP	NP	NP
7. Special reinforced masonry shear walls	14.4 and 14.4.3	5	2½	3½	NL	NL	160	160	100
8. Intermediate reinforced masonry shear walls	14.4 and 14.4.3	3½	2½	2¼	NL	NL	NP	NP	NP
9. Ordinary reinforced masonry shear walls	14.4	2	2½	1¾	NL	160	NP	NP	NP
10. Detailed plain masonry shear walls	14.4	2	2½	1¾	NL	NP	NP	NP	NP
11. Ordinary plain masonry shear walls	14.4	1½	2½	1¼	NL	NP	NP	NP	NP
12. Prestressed masonry shear walls	14.4	1½	2½	1¾	NL	NP	NP	NP	NP
13. Light-framed walls sheathed with wood structural panels rated for shear resistance or steel sheets	14.1, 14.1.4.2, and 14.5	6½	3	4	NL	NL	65	65	65
14. Light-framed walls with shear panels of all other materials	14.1, 14.1.4.2, and 14.5	2	2½	2	NL	NL	35	NP	NP
15. Light-framed wall systems using flat strap bracing	14.1, 14.1.4.2, and 14.5	4	2	3½	NL	NL	65	65	65
<u>16. Ordinary reinforced AAC masonry shear walls</u>	<u>14.4.5.4</u>	<u>2</u>	<u>2 ½</u>	<u>2</u>	<u>NL</u>	<u>35</u>	<u>NP</u>	<u>NP</u>	<u>NP</u>
<u>17. Plain AAC masonry shear walls</u>	<u>14.4.5.3</u>	<u>1 ½</u>	<u>2 ½</u>	<u>1 ½</u>	<u>NL</u>	<u>NP</u>	<u>NP</u>	<u>NP</u>	<u>NP</u>

B. BUILDING FRAME SYSTEMS									
1. Steel eccentrically braced frames, moment-resisting connections at columns away from links	14.1	8	2	4	NL	NL	160	160	100
2. Steel eccentrically braced frames, non-moment-resisting, connections at columns away from links	14.1	7	2	4	NL	NL	160	160	100
23. Special steel concentrically braced frames	14.1	6	2	5	NL	NL	160	160	100
34. Ordinary steel concentrically braced frames	14.1	3 ¹ / ₄	2	3 ¹ / ₄	NL	NL	35 ^j	35 ^j	NP ^j
45. Special reinforced concrete shear walls	14.2 and 14.2.3.6	6	2 ¹ / ₂	5	NL	NL	160	160	100
56. Ordinary reinforced concrete shear walls	14.2 and 14.2.3.4	5	2 ¹ / ₂	4 ¹ / ₂	NL	NL	NP	NP	NP
67. Detailed plain concrete shear walls	14.2 and 14.2.3.2	2	2 ¹ / ₂	2	NL	NP	NP	NP	NP
78. Ordinary plain concrete shear walls	14.2 and 14.2.3.1	1 ¹ / ₂	2 ¹ / ₂	1 ¹ / ₂	NL	NP	NP	NP	NP
89. Intermediate precast shear walls	14.2 and 14.2.3.5	5	2 ¹ / ₂	4 ¹ / ₂	NL	NL	40 ^k	40 ^k	40 ^k
94. Ordinary precast shear walls	14.2 and 14.2.3.3	4	2 ¹ / ₂	4	NL	NP	NP	NP	NP
104. Composite steel and concrete eccentrically braced frames	14.3	8	2	4	NL	NL	160	160	100
112. Composite steel and concrete concentrically braced frames	14.3	5	2	4 ¹ / ₂	NL	NL	160	160	100
123. Ordinary composite steel and concrete braced frames	14.3	3	2	3	NL	NL	NP	NP	NP
134. Composite steel plate shear walls	14.3	6 ¹ / ₂	2 ¹ / ₂	5 ¹ / ₂	NL	NL	160	160	100
145. Special composite reinforced concrete shear walls with steel elements	14.3	6	2 ¹ / ₂	5	NL	NL	160	160	100
156. Ordinary composite reinforced concrete shear walls with steel elements	14.3	5	2 ¹ / ₂	4 ¹ / ₂	NL	NL	NP	NP	NP
167. Special reinforced masonry shear walls	14.4	5 ¹ / ₂	2 ¹ / ₂	4	NL	NL	160	160	100
178. Intermediate reinforced masonry shear walls	14.4	4	2 ¹ / ₂	4	NL	NL	NP	NP	NP
189. Ordinary reinforced masonry shear walls	14.4	2	2 ¹ / ₂	2	NL	160	NP	NP	NP
192. Detailed plain masonry shear walls	14.4	2	2 ¹ / ₂	2	NL	NP	NP	NP	NP
204. Ordinary plain masonry shear walls	14.4	1 ¹ / ₂	2 ¹ / ₂	1 ¹ / ₄	NL	NP	NP	NP	NP
212. Prestressed masonry shear walls	14.4	1 ¹ / ₂	2 ¹ / ₂	1 ³ / ₄	NL	NP	NP	NP	NP
223. Light-framed walls sheathed with wood structural panels rated for shear resistance or steel sheets	14.1, 14.1.4.2, and 14.5	7	2 ¹ / ₂	4 ¹ / ₂	NL	NL	65	65	65
234. Light-framed walls with shear panels of all	14.1, 14.1.4.2, and 14.5	2 ¹ / ₂	2 ¹ / ₂	2 ¹ / ₂	NL	NL	35	NP	NP

other materials									
25. Buckling-restrained braced frames, non-moment-resisting beam-column connections	14.1	7	2	5½	NL	NL	160	160	100
246. Buckling-restrained braced frames, moment-resisting beam-column connections	14.1	8	2½	5	NL	NL	160	160	100
257. Special steel plate shear wall	14.1	7	2	6	NL	NL	160	160	100
C. MOMENT-RESISTING FRAME SYSTEMS									
1. Special steel moment frames	14.1 and 12.2.5.5	8	3	5½	NL	NL	NL	NL	NL
2. Special steel truss moment frames	14.1	7	3	5½	NL	NL	160	100	NP
3. Intermediate steel moment frames	12.2.5.6, 12.2.5.7, 12.2.5.8, 12.2.5.9, and 14.1	4.5	3	4	NL	NL	35 ^{h,i}	NP ^h	NP ⁱ
4. Ordinary steel moment frames	12.2.5.6, 12.2.5.7, 12.2.5.8, and 14.1	3.5	3	3	NL	NL	NP ^h	NP ^h	NP ⁱ
5. Special reinforced concrete moment frames	12.2.5.5 and 14.2	8	3	5½	NL	NL	NL	NL	NL
6. Intermediate reinforced concrete moment frames	14.2	5	3	4½	NL	NL	NP	NP	NP
7. Ordinary reinforced concrete moment frames	14.2	3	3	2½	NL	NP	NP	NP	NP
8. Special composite steel and concrete moment frames	12.2.5.5 and 14.3	8	3	5½	NL	NL	NL	NL	NL
9. Intermediate composite moment frames	14.3	5	3	4½	NL	NL	NP	NP	NP
10. Composite partially restrained moment frames	14.3	6	3	5½	160	160	100	NP	NP
11. Ordinary composite moment frames	14.3	3	3	2½	NL	NP	NP	NP	NP
12. Cold-formed steel – special bolted frame ^m	14.1	3½	3 ^l	3½	35	35	35	35	35
D. DUAL SYSTEMS WITH SPECIAL MOMENT FRAMES CAPABLE OF RESISTING AT LEAST 25% OF PRESCRIBED SEISMIC FORCES									
1. Steel eccentrically braced frames	14.1	8	2½	4	NL	NL	NL	NL	NL
2. Special steel concentrically braced frames	14.1	7	2½	5½	NL	NL	NL	NL	NL
3. Special reinforced concrete shear walls	14.2	7	2½	5½	NL	NL	NL	NL	NL
4. Ordinary reinforced concrete shear walls	14.2	6	2½	5	NL	NL	NP	NP	NP
5. Composite steel and concrete eccentrically braced frames	14.3	8	2½	4	NL	NL	NL	NL	NL
6. Composite steel and concrete concentrically braced frames	14.3	6	2½	5	NL	NL	NL	NL	NL
7. Composite steel plate	14.3	7½	2½	6	NL	NL	NL	NL	NL

shear walls									
8. Special composite reinforced concrete shear walls with steel elements	14.3	7	2½	6	NL	NL	NL	NL	NL
9. Ordinary composite reinforced concrete shear walls with steel elements	14.3	6	2½	5	NL	NL	NP	NP	NP
10. Special reinforced masonry shear walls	14.4	5½	3	5	NL	NL	NL	NL	NL
11. Intermediate reinforced masonry shear walls	14.4	4	3	3½	NL	NL	NP	NP	NP
12. Buckling-restrained braced frame	14.1	8	2½	5	NL	NL	NL	NL	NL
13. Special steel plate shear walls	14.1	8	2½	6½	NL	NL	NL	NL	NL
E. DUAL SYSTEMS WITH INTERMEDIATE MOMENT FRAMES CAPABLE OF RESISTING AT LEAST 25% OF PRESCRIBED SEISMIC FORCES	12.2.5.1								
1. Special steel concentrically braced frames ^f	14.1	6	2½	5	NL	NL	35	NP	NP ^{h,k}
2. Special reinforced concrete shear walls	14.2	6½	2½	5	NL	NL	160	100	100
3. Ordinary reinforced masonry shear walls	14.4	3	3	2½	NL	160	NP	NP	NP
4. Intermediate reinforced masonry shear walls	14.4	3½	3	3	NL	NL	NP	NP	NP
5. Composite steel and concrete concentrically braced frames	14.3	5½	2½	4½	NL	NL	160	100	NP
6. Ordinary composite braced frames	14.3	3½	2½	3	NL	NL	NP	NP	NP
7. Ordinary composite reinforced concrete shear walls with steel elements	14.3	5	3	4½	NL	NL	NP	NP	NP
8. Ordinary reinforced concrete shear walls	14.2	5½	2½	4½	NL	NL	NP	NP	NP
F. SHEAR WALL-FRAME INTERACTIVE SYSTEM WITH ORDINARY REINFORCED CONCRETE MOMENT FRAMES AND ORDINARY REINFORCED CONCRETE SHEAR WALLS	12.2.5.10 and 14.2	4½	2½	4	NL	NP	NP	NP	NP
G. CANTILEVERED COLUMN SYSTEMS DETAILED TO CONFORM TO THE REQUIREMENTS FOR:	12.2.5.2								
1. Special steel moment frames	12.2.5.5 and 14.1	2½	1¼	2½	35	35	35	35	35
2. Intermediate steel moment frames	14.1	1½	1¼	1½	35	35	35 ^h	NP ^{h,i}	NP ^{h,i}
3. Ordinary steel moment frames	14.1	1¼	1¼	1¼	35	35	NP	NP ^{h,i}	NP ^{h,i}

4. Special reinforced concrete moment frames	12.2.5.5 and 14.2	2½	1¼	2½	35	35	35	35	35
5. Intermediate concrete moment frames	14.2	1½	1¼	1½	35	35	NP	NP	NP
6. Ordinary concrete moment frames	14.2	1	1¼	1	35	NP	NP	NP	NP
7. Timber frames	14.5	1½	1½	1½	35	35	35	NP	NP
H. STEEL SYSTEMS NOT SPECIFICALLY DETAILED FOR SEISMIC RESISTANCE, EXCLUDING CANTILEVER COLUMN SYSTEMS	14.1	3	3	3	NL	NL	NP	NP	NP

^aResponse modification coefficient, R , for use throughout the standard. Note R reduces forces to a strength level, not an allowable stress level.

^bReflection amplification factor, C_d , for use in Sections 12.8.6, 12.8.7, and 12.9.2

^cNL = Not Limited and NP = Not Permitted. For metric units use 30.5 m for 100 ft and use 48.8 m for 160 ft. Heights are measured from the base of the structure as defined in Section 11.2.

^dSee Section 12.2.5.4 for a description of building systems limited to buildings with a height of 240 ft (73.2 m) or less.

^eSee Section 12.2.5.4 for building systems limited to buildings with a height of 160 ft (48.8 m) or less.

^fOrdinary moment frame is permitted to be used in lieu of intermediate moment frame for Seismic Design Categories B or C.

^gThe tabulated value of the overstrength factor, Ω_0 , is permitted to be reduced by subtracting one-half for structures with flexible diaphragms, but shall not be taken as less than 2.0 for any structure.

^hSee Sections 12.2.5.6 and 12.2.5.7 for limitations for steel OMFs and IMFs in structures assigned to Seismic Design Category D or E.

ⁱSee Sections 12.2.5.8 and 12.2.5.9 for limitations for steel OMFs and IMFs in structures assigned to Seismic Design Category F.

^jSteel ordinary concentrically braced frames are permitted in single-story buildings up to a height of 60 ft (18.3 m) where the dead load of the roof does not exceed 20 psf (0.96 kN/m²) and in penthouse structures.

^lAlternatively, the seismic load effect with overstrength, E_{ms} , can be based on the expected strength determined in accordance with AISI S110.

^mCold-formed steel – special bolted moment frames shall be limited to one story in height in accordance with AISI S110.

TABLE 12.6-1, PERMITTED ANALYTICAL PROCEDURES

Replace with the following:

Table 12.6-1 Permitted Analytical Procedures

Seismic Design Category	Structural Characteristics	Equivalent Lateral Force Analysis Section 12.8	Modal Response Spectrum Analysis Section 12.9	Seismic Response History Procedures Chapter 16
B, C	All structures	P	P	P
D, E, F	Regular structures not exceeding 160 feet in height and all structures of light frame construction	P	P	P
	Regular structures equal to or exceeding 160 feet in height with $T < 3.5 T_s$	P	P	P
	Irregular structures not exceeding 160 feet in height and having only horizontal irregularities type 2, 3, 4, or 5 of Table 12.3-1 or vertical irregularities type 4, 5a or 5b of Table 12.3-2	P	P	P
	All other structures	NP	P	P

Note: P – Permitted; NP – Not permitted.

SECTION 12.8.7, P-DELTA LIMIT

Replace with the following:

12.8.7 P-delta Limit. Stability coefficient, θ , as determined for each level of the structure by the following equation, shall not exceed 0.10:

$$\theta = \frac{P_x A I}{V_x h_{sx} C_d} \quad (12.8-16)$$

where:

- P_x = the total vertical design load at and above Level x . Where calculating the vertical design load for purposes of determining P-delta effects, the individual load factors need not exceed 1.0.
- A = the design story drift calculated in accordance with Section 12.8.6.
- I = the occupancy importance factor determined in accordance with Section 11.5.1.
- V_x = the seismic shear force acting between Level x and $x - 1$.
- h_{sx} = the story height below Level x .
- C_d = the deflection amplification factor from Table 12.2-1

EXCEPTION: The stability coefficient, θ , shall be permitted to exceed 0.10 if either of the following applies:

1. The resistance to lateral forces is determined to increase continuously in a monotonic nonlinear static (pushover) analysis according to ASCE/SEI 41 Section 3.3.3.3.2 using S_a defined as a MCE_R spectral response acceleration according to the *Provisions* at the effective fundamental period. Modeling and analysis shall conform to ASCE/SEI 41 Section 3.3.3, except that the analysis shall be done for seismic actions occurring simultaneously with the effects of dead load in combination with not less than 25 percent of the required design live loads, reduced as permitted for the area of a single floor. Degradation shall be modeled and P-delta effects shall be included in the analysis. A review of the nonlinear static analysis shall be performed by an independent team having experience in seismic analysis methods and the theory and application of nonlinear seismic analysis and structural behavior under earthquake loading. The review team shall be composed of at least two members including at least one registered design professional.
2. Compliance with the provisions of the nonlinear response history procedure in Chapter 16 is demonstrated.

SECTION 12.11.2.2.1, TRANSFER OF ANCHORAGE FORCES INTO DIAPHRAGM

Replace with the following:

12.11.2.2.1 Transfer of Anchorage Forces into Diaphragm. Diaphragms shall be provided with continuous ties or struts between diaphragm chords to distribute these anchorage forces into the diaphragm.

EXCEPTION: In buildings with diaphragms of light-frame construction, continuous cross-ties are not required provided all of the following are satisfied:

1. The unsupported height of the wall does not exceed 12 feet,
2. Anchorages are spaced no more than 4 feet on center,
3. The length of the diaphragm in the direction parallel to the wall being anchored does not exceed 2.5 times the length of the diaphragm in the orthogonal direction, and
4. The anchorage connection extends far enough into the diaphragm to transfer the anchorage force into the diaphragm.

Diaphragm connections shall be positive, mechanical, or welded. Added chords are permitted to be used to form subdiaphragms to transmit the anchorage forces to the main continuous cross-ties. The maximum length-to-width ratio of the structural subdiaphragm shall be 2.5 to 1. Connections and anchorages capable of resisting the prescribed forces shall be provided between the diaphragm and the attached components. Connections shall extend into the diaphragm a sufficient distance to develop the force transferred into the diaphragm.

SECTION 12.11.2.2.3, WOOD DIAPHRAGMS

Replace with the following:

12.11.2.2.3 Wood Diaphragms. In wood diaphragms, the continuous ties shall be in addition to the diaphragm sheathing.

EXCEPTION: Where continuous cross-ties are not required by Section 12.11.2.2.1 and the anchorage connections extend into the diaphragm a sufficient distance to develop the force transferred into the diaphragm sheathing.

Anchorage shall not be accomplished by use of toenails or nails subject to withdrawal nor shall wood ledgers or framing be used in cross-grain bending or cross-grain tension. The diaphragm sheathing shall not be considered effective as providing the ties or struts required by this section.

SECTION 12.14.7.5.1, TRANSFER OF ANCHORAGE FORCES INTO DIAPHRAGM

Replace with the following:

12.14.7.5.1 Transfer of Anchorage Forces into Diaphragm. Diaphragms shall be provided with continuous ties or struts between diaphragm chords to distribute these anchorage forces into the diaphragm.

EXCEPTION: In buildings with diaphragms of light-framed construction, continuous cross-ties are not required provided all of the following are satisfied:

1. The unsupported height of the wall does not exceed 12 feet,
2. Anchorages are spaced no more than 4 feet on center,
3. The length of the diaphragm in the direction parallel to the wall being anchored does not exceed 2.5 times the length of the diaphragm in the orthogonal direction, and
4. The connection extends far enough into the diaphragm to transfer the anchorage force into the diaphragm.

Added chords are permitted to be used to form subdiaphragms to transmit the anchorage forces to the main continuous cross-ties. The maximum length-to-width ratio of the structural subdiaphragm shall be 2.5 to 1. Connections and anchorages capable of resisting the prescribed forces shall be provided between the diaphragm and the attached components. Connections shall extend into the diaphragm a sufficient distance to develop the force transferred into the diaphragm.

SECTION 12.14.7.5.2, WOOD DIAPHRAGMS

Replace with the following:

12.14.7.5.2 Wood Diaphragms. In wood diaphragms, the continuous ties shall be in addition to the diaphragm sheathing.

EXCEPTION: Where continuous cross-ties are not required by Section 12.14.7.5.1 and the anchorage connections extend into the diaphragm a sufficient distance to develop the force transferred into the diaphragm sheathing.

Anchorage shall not be accomplished by use of toenails or nails subject to withdrawal nor shall wood ledgers or framing be used in cross-grain bending or cross-grain tension. The diaphragm sheathing shall not be considered effective as providing the ties or struts required by this section.

SECTION 12.14.8.1, SEISMIC BASE SHEAR

Revise, in part, to read as follows:

. . . In calculating S_{DS} , S_s shall be in accordance with Section 11.4.3, but need not be taken larger than 1.5.

[Remainder of section stays the same.]

Commentary to Chapter 12 Modifications

COMMENTARY TO SECTION 12.6

C12.6 ANALYSIS SELECTION PROCEDURE

Table 12.6-1 applies only to buildings without seismic isolation (Chapter 17) or passive energy devices (Chapter 18). The four basic procedures addressed in Table 12.6-1 are equivalent lateral force (ELF) analysis (Section 12.8), modal response spectrum (MRS) analysis (Section 12.9), linear response history (LRH) analysis, and nonlinear response history (NRH) analysis. Requirements for performing response history analysis are provided in Chapter 16. Nonlinear static (pushover) analysis is not provided as an “approved” analysis procedure in ASCE/SEI 7-05. The value of $T_s = S_{D1}/S_{DS}$ depends on the site class because S_{DS} and S_{D1} include such effects. When ELF is not allowed, the analysis must be performed using modal response spectrum or response history analysis.

ELF is not allowed for buildings with the listed irregularities because it assumes a gradually varying distribution of mass and stiffness along the height and negligible torsional response. The $3.5T_s$ limit recognizes that higher modes are more significant in taller buildings (Lopez and Cruz, 1996; Chopra, 2007), such that the ELF method may underestimate the design base shear and may not predict correctly the vertical distribution of seismic forces.

Table C12.6-1 demonstrates that $3.5T_s$ generally increases as ground motion intensity increases and as soils become softer. Assuming that the fundamental building period is about 0.1 times the number of stories, the maximum building height for which the ELF applies ranges from about 10 stories for low seismic hazard sites with firm soil to 30 stories for high seismic hazard sites with soft soil. Since this trend was not intended, the modification to Section 12.6 adds a height limit of 160 feet.

Table C12.6-1 Values of $3.5T_s$ for Various Cities and Various Site Classes

Location	S_s (g)	S_1 (g)	$3.5T_s$ (seconds) for Site Class			
			A&B	C	D	E
Denver	0.219	0.057	0.91	1.29	1.37	1.07
Boston	0.275	0.067	0.85	1.21	1.30	1.03
New York City	0.359	0.070	0.68	0.97	1.08	0.93
Las Vegas	0.582	0.179	1.08	1.50	1.68	1.89
St. Louis	0.590	0.169	1.00	1.40	1.60	1.81
San Diego	1.128	0.479	1.31	1.73	1.99	2.91
Memphis	1.341	0.368	0.96	1.38	1.59	2.25
Charleston	1.414	0.348	0.86	1.25	1.47	2.08
Seattle	1.448	0.489	1.18	1.55	1.78	2.63
San Jose	1.500	0.600	1.40	1.82	2.10	2.12
Salt Lake City	1.672	0.665	1.39	1.81	2.09	3.10

COMMENTARY TO SECTION 12.8.7

C12.8.7 P-delta Limit. ASCE/SEI 7-05 allows amplified forces to be used in a linear elastic analysis where the stability coefficient, θ , exceeds 0.10. By comparison, FEMA 350 requires explicit modeling of P-delta effects for steel moment-resisting frames where θ exceeds approximately 0.04. Where the tangent stiffness of the structure may become negative, dynamic displacement demands can increase significantly (Gupta and Krawinkler, 2000). Structures with θ not greater than 0.10 generally are expected to have a positive tangent stiffness, depending on the progression of plastic hinging and strain hardening. The 2009 *Provisions* allows structures to exceed this limit only if a nonlinear static analysis including P-delta effects demonstrates that the tangent stiffness remains positive up to the target displacement computed for the MCE_R or if nonlinear dynamic analysis demonstrates adequate resistance to instability.

The occupancy importance factor, I , is inserted into Equation 12.8-16 to correct an error in ASCE/SEI 7. In this way, the stability coefficient is based on the elastic stiffness of the system.

ADDITIONAL REFERENCES FOR CHAPTER 12 COMMENTARY

Federal Emergency Management Agency. 2000. *Recommended Seismic Design Criteria for New Steel Moment-Frame Buildings*, FEMA 350. Prepared for FEMA by the SAC Joint Venture. Federal Emergency Management Agency, Washington, D.C.

Gupta, A., and H. Krawinkler. 2000. “Dynamic P-delta effects for flexible inelastic steel structures,” *ASCE Journal of Structural Engineering*, 126(1):145-154.

Modifications to Chapter 13, Seismic Design Requirements for Nonstructural Elements

SECTION 13.6.5.5, ADDITIONAL REQUIREMENTS [FOR COMPONENT SUPPORTS]

Replace Item 6f with the following:

Attachments into concrete utilize anchors that have not been prequalified for seismic applications in accordance with ACI 355.2.

SECTION 13.6.8.2, FIRE PROTECTION SPRINKLER SYSTEMS IN SEISMIC DESIGN CATEGORY C

Replace with the following:

13.6.8.2 Fire Protection Sprinkler Systems. Fire protection sprinkler systems designed and constructed in accordance with NFPA 13 shall be deemed to meet the other requirements of this section.

SECTION 13.6.8.3, FIRE PROTECTION SPRINKLER SYSTEMS IN SEISMIC DESIGN CATEGORIES D THROUGH F

Delete this section and renumber remaining sections.

Commentary to Chapter 13 Modifications

COMMENTARY TO SECTION 13.6.5.5

C13.6.5.5 Additional Requirements [for Component Supports]. As reflected in this section of the standard and in the footnote to Table 13.6-1, vibration isolated equipment with snubbers is subject to amplified loads as a result of dynamic impact.

Use of expansion anchors for non-vibration isolated mechanical equipment rated over 10 hp is prohibited based on experience with older anchor types. The ASCE 7 Seismic Subcommittee is considering a proposal that also would exempt anchors qualified by simulated seismic testing and long-term vibration testing.

The previous language in Item 6f was intended to identify anchor types that would be considered non-ductile. The previous requirement has been superseded by requirements for qualification that include checks for ductility and good performance in earthquake conditions.

COMMENTARY TO SECTION 13.6.8.2

C13.6.8.2 Fire Protection Sprinkler Systems. NFPA 13-2007 applies to Seismic Design Categories C, D, E, and F. The lateral design procedures of NFPA 13-2007 have been revised for consistency with the ASCE/SEI 7-05 design approach while retaining traditional sprinkler system design concepts. Using conservative upper-bound values of the various design parameters, a single lateral force coefficient, C_p , was developed. It is a function of the mapped short period response parameter S_s . Stresses in the pipe and connections are controlled by limiting the maximum reaction at bracing points as a function of pipe diameter.

In Seismic Design Category C, the prescriptive requirements of NFPA 13-2007, using a default lateral force of 50 percent of the weight of the water-filled pipe, provide a conservative design, although application of the NFPA sway bracing calculation may produce a lower design lateral force.

Page intentionally left blank.

Modifications to Chapter 14, Material Specific Seismic Design and Detailing Requirements

SECTION 14.1, STEEL

Replace with the following:

14.1 STEEL

Structures, including foundations, constructed of steel to resist seismic loads shall be designed and detailed in accordance with this standard including the reference documents and additional requirements provided in this section.

14.1.1 Reference Documents. The design, construction, and quality of steel components that resist seismic forces shall conform to the applicable requirements of the following as amended herein:

1. AISC 360
2. AISC 341
3. AISI NAS
4. AISI S110
5. AISI-GP
6. AISI-PM
7. AISI Lateral
8. AISI WSD
9. ASCE 19
10. ASCE 8
11. SJI Tables

14.1.1.1 Modifications to AISC 341-05. The text of AISC 341 shall be modified as indicated in Sections 14.1.1.1.1 and 14.1.1.1.2. Italics are used for text to indicate requirements that differ from AISC 341.

14.1.1.1.1 Replace Section 15.7 with the following:

15.7 Beam-to-Column Connections

Where a brace or gusset plate connects to both members at a beam-to-column connection, the connection shall conform to one of the following:

- (1) *The connection shall accommodate the required rotation at a minimum story drift of 2.5 percent of the story height or*
- (2) *The connection shall be designed to resist a moment equal to the lesser of the following:*
 - (i) *A moment corresponding to $1.1R_yF_yZ$ (LRFD) or $(1.1/1.5)R_yF_yZ$ (ASD), as appropriate, of the beam.*
 - (ii) *A moment corresponding to $\Sigma 1.1R_yF_yZ$ (LRFD) or $\Sigma[(1.1/1.5)R_yF_yZ]$ (ASD), as appropriate, of the column.*

This moment shall be considered in combination with the required strength of the brace connection and beam connection, including amplified diaphragm collector forces.

14.1.1.1.2 Add new Section 16.7 as follows:

16.7 Beam-to-Column Connections

Where a brace or gusset plate connects to both members at a beam-to-column connection, the connection shall conform to one of the following:

- (1) *The connection shall accommodate the required rotation at a minimum story drift of 2.5 percent of the story height or*
- (2) *The connection shall be designed to resist a moment equal to the lesser of the following:*
 - (i) *A moment corresponding to $1.1R_yF_yZ$ (LRFD) or $(1.1/1.5)R_yF_yZ$ (ASD), as appropriate, of the beam.*
 - (ii) *A moment corresponding to $\Sigma 1.1R_yF_yZ$ (LRFD) or $\Sigma[(1.1/1.5)R_yF_yZ]$ (ASD), as appropriate, of the column.*

This moment shall be considered in combination with the required strength of the brace connection and beam connection, including amplified diaphragm collector forces.

14.1.2 Seismic Design Categories B and C. Steel structures assigned to Seismic Design Category B or C shall be of any construction permitted by the reference documents in Section 14.1.1. An R factor as set forth in Table 12.2-1 is permitted where the structure is designed and detailed in accordance with the requirements of AISC 341 for structural steel buildings, AISI S110 for cold-formed steel construction, or AISI Lateral for light-framed cold-formed steel construction. Systems not detailed in accordance with AISC 341, AISI S110, or AISI Lateral shall use the R factor designated for “Structural steel systems not specifically detailed for seismic resistance” in Table 12.2-1.

14.1.3 Seismic Design Categories D through F. Steel structures assigned to Seismic Design Category D, E, or F shall be designed and detailed in accordance with AISC 341 for structural steel, AISI S110 for cold-formed steel construction, or AISI Lateral for light-framed cold-formed steel construction.

14.1.4 Cold-formed Steel. The design of cold-formed carbon or low-alloy steel to resist seismic loads shall be in accordance with the requirements of AISI NAS, AISI S110 and the design of cold-formed stainless steel structural members to resist seismic loads shall be in accordance with the requirements of ASCE 8.

14.1.4.1 Modifications to AISI S110 (2007 edition). The text of AISI S110 shall be modified as indicated in Sections 14.1.4.1.1 through 14.1.2.1.5. Italics are used for text within Sections 14.1.4.1.1 through 14.1.2.1.5 to indicate requirements that differ from AISI S110.

14.1.4.1.1 AISI S110, Section D1. Revise Section D1 to read as follows:

D1 Cold-Formed Steel Special Bolted Moment Frames (CFS-SBMF)

Cold-formed steel–special bolted moment frames (CFS-SBMF) systems shall withstand inelastic deformations through friction and bearing at their bolted connections. Beams, columns, and connections shall satisfy the requirements in this section. CFS-SBMF systems shall be limited to one-story structures, no greater than 35 feet in height, without column splices and satisfying the requirements in this section. *The SBMF shall engage all columns supporting the roof or floor above. The single size beam and single size column with the same bolted moment connection detail shall be used for each frame. The frame is to be supported on a level floor or foundation.*

14.1.4.1.2 AISI S110, Section D1.1.1. Revise Section D1.1.1 to read as follows:

D1.1.1 Connection Limitations

Beam-to-column connections in CFS-SBMF systems shall be bolted connections with snug-tight high-strength bolts. The bolt spacing and edge distance shall be in accordance with the limits of AISI S100, Section E3. *The 8-bolt configuration shown in Table D1-1 shall be used. The faying surfaces of the beam and column in the bolted moment connection region shall be free of any lubricants or debris.*

14.1.4.1.3 AISI S110, Section D1.2.1. Revise Section D1.2.1 to read as follows:

D1.2.1 Beam Limitations

In addition to the requirements of Section D1.2.3, beams in CFS-SBMF systems shall be *ASTM A653 Gr. 55 galvanized steel* cold-formed C-sections members with lips, and designed in accordance with Chapter C of AISI S100. *The beam depth shall be between 12 in (305 mm) and 20 in (508 mm).* The flat depth-to-thickness ratio of the web shall not exceed $6.18\sqrt{E/F_y}$.

14.1.4.1.4 AISI S110, Section D1.2.2. Revise Section D1.2.2 to read as follows:

D1.2.2 Column Limitations

In addition to the requirements of D1.2.3, columns in CFS-SBMF systems shall be *ASTM A500 Gr. B* cold-formed hollow structural section (HSS) members *painted with a standard industrial finished surface*, and designed in accordance with Chapter C of AISI S100. *The column depth shall be between 8 in (203 mm) and 12 in (305 mm).* The flat depth-to-thickness ratio shall not exceed $1.40\sqrt{E/F_y}$.

14.1.4.1.5 AISI S110, Section D1.3. Revise Section D1.3 to read as follows:

D1.3 Design Story Drift

Where the applicable building code does not contain design coefficients for CSF-SBMF systems, the provisions of Appendix 1 shall apply. The design story drift shall not exceed $0.03h$, unless approved by authority having jurisdiction. *In no case shall the design story drift exceed $0.05h$.*

For structures having a period less than T_S , as defined in the applicable building code, alternate methods of computing Δ shall be permitted, provided such alternate methods are acceptable to the authority having jurisdiction.

[Remainder of Section 14.1 is unchanged.]

SECTION 14.2.2, MODIFICATIONS TO ACI 318

Replace with the following:

14.2.2 Modifications to ACI 318. The text of ACI 318 shall be modified as indicated in Sections 14.2.2.1 through 14.2.2.9. Italics are used for text within Sections 14.2.2.1 through 14.2.2.9 to indicate provisions that differ from ACI 318.

14.2.2.1 Definitions. Add the following definitions to Section 2.2.

DETAILED PLAIN CONCRETE STRUCTURAL WALL: *A wall complying with the requirements of Chapter 22.*

ORDINARY PRECAST STRUCTURAL WALL: *A precast wall complying with the requirements of Chapters 1 through 18.*

WALL PIER: *A wall segment with a horizontal length-to-thickness ratio of at least 2.5, but not exceeding 6, whose clear height is at least two times its horizontal length.*

14.2.2.2 ACI 318, Section 7.10. Modify Section 7.10 by revising Section 7.10.5.6 to read as follows:

7.10.5.6 Where anchor bolts are placed in the top of columns or pedestals, the bolts shall be enclosed by lateral reinforcement that also surrounds at least four vertical bars of the column or pedestal. The lateral reinforcement shall be distributed within 5 in. of the top of the column or pedestal, and shall consist of at least two No.4 or three No.3 bars. *In structures assigned to Seismic Design Categories C, D, E or F, the ties shall have a hook on each free end that complies with 7.1.4.*

14.2.2.3 Scope. Modify Section 21.1.1.3 to read as follows:

21.1.1.3 All members shall satisfy requirements of Chapters 1 to 19 and 22. Structures assigned to SDC B, C, D, E, or F also shall satisfy 21.1.1.4 through 21.1.1.8, as applicable, *except as modified by the requirements of Chapters 14 and 15 of this document.*

14.2.2.4 Intermediate Precast Structural Walls: Modify Section 21.4 by renumbering Section 21.4.3 to Section 21.4.4 and adding new Sections 21.4.3 and 21.4.5, to read as follows:

21.4 *Connections that are designed to yield shall be capable of maintaining 80 percent of their design strength at the deformation induced by design displacement, or shall use type 2 mechanical splices.*

21.4.4 *Elements of the connection that are not designed to yield shall develop at least $1.5 S_y$.*

21.4.5 *Wall piers not designed as part of a moment frame shall have transverse reinforcement designed to resist the shear forces determined from Section 21.3.3. Spacing of transverse reinforcement shall not exceed 8 in. Transverse reinforcement shall be extended beyond the pier clear height for at least 12 in.*

EXCEPTIONS: *The preceding requirement need not apply in the following situations:*

1. *Wall piers that satisfy Section 21.13.*
2. *Wall piers along a wall line within a story where other shear wall segments provide lateral support to the wall piers and such segments have a total stiffness of at least six times the sum of the in-plane stiffnesses of all the wall piers.*

Wall segments with a horizontal length-to-thickness ratio less than 2.5 shall be designed as columns.

14.2.2.5 Wall Piers and Wall Segments. Modify Section 21.9 by adding a new Section 21.9.10 to read as follows:

21.9.10 Wall Piers and Wall Segments in Special Structural Walls.

21.9.10.1 Wall piers not designed as a part of a special moment-resisting frame shall have transverse reinforcement designed to satisfy the requirements in Section 21.9.10.2.

EXCEPTIONS:

1. Wall piers that satisfy Section 21.13.
2. Wall piers along a wall line within a story where other shear wall segments provide lateral support to the wall piers, and such segments have a total stiffness of at least six times the sum of the in-plane stiffnesses of all the wall piers.

21.9.10.2 Transverse reinforcement with seismic hooks at both ends shall be designed to resist the shear forces determined from Section 21.6.5.1. Spacing of transverse reinforcement shall not exceed 6 in. (152 mm). Transverse reinforcement shall be extended beyond the pier clear height for at least 12 in. (304 mm).

21.9.10.3 Wall segments with a horizontal length-to-thickness ratio less than 2.5 shall be designed as columns.

14.2.2.6 Special Precast Structural Walls. Modify Section 21.10.2 to read as follows:

21.10.2 Special structural walls constructed using precast concrete shall satisfy all the requirements of Section 21.9 in addition to 21.4 as modified in Section 14.2.2.7.

14.2.2.7 Foundations. Modify Section 21.12.1.1 to read as follows:

21.12.1.1 Foundations resisting earthquake-induced forces or transferring earthquake-induced forces between structure and ground shall comply with requirements of Section 21.12 and other applicable code provisions unless modified by Sections 12.1.5, 12.13 or 14.2 of ASCE/SEI 7-05.

14.2.2.8 Detailed Plain Concrete Shear Walls. Modify Section 22.6 by adding a new Section 22.6.7 to read:

22.6.7 Detailed Plain Concrete Shear Walls.

22.6.7.1 Detailed plain concrete shear walls are walls conforming to the requirements for ordinary plain concrete shear walls and 22.6.7.2

22.6.7.2 Reinforcement shall be provided as follows:

- a. Vertical reinforcement of at least 0.20 in.^2 (129 mm^2) in cross-sectional area shall be provided continuously from support to support at each corner, at each side of each opening, and at the ends of walls. The continuous vertical bar required beside an opening is permitted to substitute for the No. 5 bar required by Section 22.6.6.5.
- b. Horizontal reinforcement at least 0.20 in.^2 (129 mm^2) in cross-sectional area shall be provided:
 1. Continuously at structurally connected roof and floor levels and at the top of walls.
 2. At the bottom of load-bearing walls or in the top of foundations where doveled to the wall
 3. At a maximum spacing of 120 in. (3048 mm).

Reinforcement at the top and bottom of openings, where used in determining the maximum spacing specified in Item 3 in the preceding text, shall be continuous in the wall.

14.2.2.9 Strength Requirements for Anchors: Modify Section D.4 by adding a new exception at the end of Section D.4.2.2 to read as follows:

EXCEPTION: If N_b is determined using Equation D-7, the concrete breakout strength of Section D.4.2 shall be considered satisfied by the design procedure of Sections D.5.2 and D.6.2 without the need for testing regardless of anchor bolt diameter and tensile embedment.

SECTIONS 14.2.3, ADDITIONAL DETAILING REQUIREMENTS FOR CONCRETE PILES, AND 14.2.3.1, CONCRETE PILE REQUIREMENTS FOR SDC C

Replace with the following:

14.2.3 Additional Detailing Requirements for Concrete Piles. In addition to the foundation requirements set forth in

ACI 318 Sections 12.1.5, 12.13 and 21.12, design, detailing and construction of concrete piles shall conform to the provisions of this section.

14.2.3.1 Concrete Pile Requirements for Seismic Design Category C. Concrete piles in structures assigned to Seismic Design Category C shall comply with the requirements of this section.

14.2.3.1.1 Anchorage of Piles. All concrete piles and concrete filled pipe piles shall be connected to the pile cap by embedding the pile reinforcement in the pile cap for a distance equal to the development length as specified in ACI 318 as modified by Section 14.2.2 of this standard or by the use of field-placed dowels anchored in the concrete pile. For deformed bars, the development length is the full development length for compression or tension, in the case of uplift, without reduction in length for excess area.

Hoops, spirals, and ties shall be terminated with seismic hooks as defined in ACI 318 Section 2.2.

Where a minimum length for reinforcement or the extent of closely spaced confinement reinforcement is specified at the top of the pile, provisions shall be made so that those specified lengths or extents are maintained after pile cut-off.

SECTION 14.2.3.2, CONCRETE PILE REQUIREMENTS FOR SEISMIC DESIGN CATEGORIES D THROUGH F

Replace Sections 14.2.3.2.1 through 14.2.3.2.5 with the following:

14.2.3.2.1 Site Class E or F Soil. Where concrete piles are used in Site Class E or F, they shall have transverse reinforcement in accordance with ACI 318 Sections 21.6.4.2 through 21.6.4.4 within seven pile diameters of the pile cap and the interfaces between strata that are hard or stiff and strata that are liquefiable or are composed of soft to medium stiff clay.

14.2.3.2.2 Nonapplicable ACI 318 Sections for Grade Beam and Piles. ACI 318 Section 21.12.3.3 need not apply where grade beams have the required strength to resist the forces from the load combinations with overstrength factor of Section 12.4.3.2 or 12.14.3.2.2. ACI 318 Section 21.12.4.4(a) need not apply to concrete piles, and Section 21.12.4.4(b) need not apply to precast, prestressed concrete piles.

14.2.3.2.3 Reinforcement for Uncased Concrete Piles (SDC D through F). Reinforcement shall be provided where required by analysis. For uncased cast-in-place drilled or augered concrete piles, a minimum of four longitudinal bars with a minimum longitudinal reinforcement ratio of 0.005 and transverse reinforcement in accordance with ACI 318 Sections 21.6.4.2 through 21.6.4.4 shall be provided throughout the minimum reinforced length of the pile as defined below starting at the top of the pile. The longitudinal reinforcement shall extend beyond the minimum reinforced length of the pile by the tension development length.

The minimum reinforced length of the pile shall be taken as the greater of:

1. One-half of the pile length;
2. A distance of 10 ft (3 m);
3. Three times the pile diameter;
4. The flexural length of the pile which shall be taken as the length of from the bottom of the pile cap to a point where the concrete section cracking moment multiplied by a resistance factor 0.4 exceeds the required factored moment at that point.

In addition, for piles located in Site Class E or F, longitudinal reinforcement and transverse confinement reinforcement, as described above, shall extend the full length of the pile.

Where transverse reinforcement is required, transverse reinforcing ties shall be a minimum of No. 3 bars for up to 20-in.-diameter (300 mm) piles and No.4 bars for piles of larger diameter.

In Site Classes A through D, longitudinal reinforcement and transverse confinement reinforcement, as defined above, shall extend a minimum of seven times the pile diameter above and below the interfaces of soft to medium stiff clay or liquefiable strata except that transverse reinforcing ties not located within the minimum reinforced length shall be permitted to use a transverse spiral reinforcement ratio of not less than one-half of that required in ACI 318 Section 21.6.4.4(a). Spacing of transverse reinforcement not located within the minimum reinforced length is permitted to be increased, but shall not exceed the least of the following:

1. 12 longitudinal bar diameters;

2. One-half the pile diameter;
3. 12 in. (305 mm).

14.2.3.2.4 Reinforcement for Metal-Cased Concrete Piles (SDC D through F). Reinforcement requirements are the same as for uncased concrete piles.

EXCEPTION: Spiral-welded metal-casing of a thickness not less than No. 14 gauge can be considered as providing concrete confinement equivalent to the closed ties or equivalent spirals required in an uncased concrete pile, provided that the metal casing is adequately protected against possible deleterious action due to soil constituents, changing water levels, or other factors indicated by boring records of site conditions.

14.2.3.2.5 Reinforcement for Precast Concrete Piles (SDC D through F). Transverse confinement reinforcement consisting of closed ties or equivalent spirals shall be provided in accordance with ACI 318 Sections 21.6.4.2 through 21.6.4.4 for the full length of the pile.

EXCEPTION: In other than Site Classes E or F, the specified transverse confinement reinforcement shall be provided within three pile diameters below the bottom of the pile cap, but it shall be permitted to use a transverse reinforcing ratio of not less than one-half of that required in ACI 318 Section 21.6.4.4(a) throughout the remainder of the pile length.

[Remainder of Section 14.2.3.2 is unchanged.]

NEW SECTION 14.2.4, ACCEPTANCE CRITERIA FOR SPECIAL PRECAST STRUCTURAL WALLS BASED ON VALIDATION TESTING

Add the following new section:

14.2.4 Acceptance Criteria for Special Precast Structural Walls Based on Validation Testing

14.2.4.1 Notation

Symbols additional to those in ACI 318 Chapter 2 are defined.

- E_{max} = maximum lateral resistance of test module determined from test results (forces or moments)
- E_n = nominal lateral resistance of test module calculated using specified geometric properties of test members, specified yield strength of reinforcement, specified compressive strength of concrete, a strain compatibility analysis or deformation compatibility analysis for flexural strength and a strength reduction factor ϕ of 1.0
- E_{nt} = calculated lateral resistance of test module using the actual geometric properties of test members, the actual strengths of reinforcement, concrete, and coupling devices, obtained by testing per Sections 14.2.4.7.7, 14.2.4.7.8, and 14.2.4.7.9, and a strength reduction factor ϕ of 1.0
- θ = drift ratio
- β = relative energy dissipation ratio

14.2.4.2 Definitions

Definitions additional to those in ACI 318 Chapter 2 are defined.

14.2.4.2.1 Coupling Elements. Devices or beams connecting adjacent vertical boundaries of structural walls and used to provide stiffness and energy dissipation for the connected assembly greater than the sum of those provided by the connected walls acting as separate units.

14.2.4.2.2 Drift Ratio. Total lateral deformation of the test module divided by the height of the test module.

14.2.4.2.3 Global Toughness. The ability of the entire lateral force resisting system of the prototype structure to maintain structural integrity and continue to carry the required gravity load at the maximum lateral displacements anticipated for the ground motions of the maximum considered earthquake.

14.2.4.2.4 Prototype Structure. The concrete wall structure for which acceptance is sought.

14.2.4.2.5 Relative Energy Dissipation Ratio. Ratio of actual to ideal energy dissipated by test module during reversed cyclic response between given drift ratio limits, expressed as the ratio of the area of the hysteresis loop for that cycle to the area of the circumscribing parallelograms defined by the initial stiffnesses during the first cycle and the peak resistances during the cycle for which the relative energy dissipation ratio is calculated. See Section 14.2.4.9.1.3.

14.2.4.2.5 Test Module. Laboratory specimen representing the critical walls of the prototype structure. See Section 14.2.4.5.

14.2.4.3 Scope and General Requirements

14.2.4.3.1 These provisions define minimum acceptance criteria for new precast structural walls, including coupled precast structural walls, designed for regions of high seismic risk or for structures assigned to high seismic performance or design categories, where acceptance is based on experimental evidence and mathematical analysis.

14.2.4.3.2 These provisions are applicable to precast structural walls, coupled or uncoupled, with height to length, h_w/l_w , ratios equal to or greater than 0.5. These provisions are applicable for either prequalifying precast structural walls for a specific structure or prequalifying a new precast wall type for construction in general.

14.2.4.3.3 Precast structural walls shall be deemed to have a response that is at least equivalent to the response of monolithic structural walls designed in accordance with ACI 318 Sections 21.1 and 21.9, and the corresponding structural walls of the prototype structure shall be deemed acceptable, when all of the conditions in Sections 14.2.4.3.3.1 through 14.2.4.3.3.5 are satisfied.

14.2.4.3.3.1 The prototype structure satisfies all applicable requirements of these provisions and of ACI 318 except Section 21.9.

14.2.4.3.3.2 Tests on wall modules satisfy the conditions in Sections 14.2.4.4 and 14.2.4.9.

14.2.4.3.3.3 The prototype structure is designed using the design procedure substantiated by the testing program.

14.2.4.3.3.4 The prototype structure is designed and analyzed using effective initial properties consistent with those determined in accordance with Section 14.2.4.7.11, and the prototype structure meets the drift limits of these provisions.

14.2.4.3.3.5 The structure as a whole, based on the results of the tests of Section 14.2.4.3.3.2 and analysis, is demonstrated to have adequate global toughness (the ability to retain its structural integrity and support its specified gravity loads) through peak displacements equal to or exceeding the story-drift ratios specified in Section 14.2.4.7.4, 14.2.4.7.5 or 14.2.4.7.6, as appropriate.

14.2.4.4 Design Procedure

14.2.4.4.1 Prior to testing, a design procedure shall be developed for the prototype structure and its walls. That procedure shall account for effects of material non-linearity, including cracking, deformations of members and connections, and reversed cyclic loading. The design procedure shall include the procedures specified in Sections 14.2.4.4.1.1 through 14.2.4.4.1.4 and shall be applicable to all precast structural walls, coupled and uncoupled, of the prototype structure.

14.2.4.4.1.1 Procedures shall be specified for calculating the effective initial stiffness of the precast structural walls, and of coupled structural walls, that are applicable to all the walls of the prototype structure.

14.2.4.4.1.2 Procedures shall be specified for calculating the lateral strength of the precast structural walls, and of coupled structural walls, applicable to all precast walls of the prototype structure.

14.2.4.4.1.3 Procedures shall be specified for designing and detailing the precast structural walls so that they have adequate ductility capacity. These procedures shall cover wall shear strength, sliding shear strength, boundary tie spacing to prevent bar buckling, concrete confinement, reinforcement strain, and any other actions or elements of the wall system that can affect ductility capacity.

14.2.4.4.1.4 Procedures shall be specified for determining that an undesirable mechanism of nonlinear response, such as a story mechanism due to local buckling of the reinforcement or splice failure, or overall instability of the wall, does not occur.

14.2.4.4.2 The design procedure shall be used to design the test modules and shall be documented in the test report.

14.2.4.4.3 The design procedure used to proportion the test specimens shall define the mechanism by which the system resists gravity and earthquake effects and shall establish acceptance values for sustaining that mechanism. Portions of the mechanism that deviate from code requirements shall be contained in the test specimens and shall be tested to determine acceptance values.

14.2.4.5 Test Modules

14.2.4.5.1 At least two modules shall be tested. At least one module shall be tested for each limiting engineering design criteria (shear, axial load and flexure) for each characteristic configuration of precast structural walls, including intersecting structural walls or coupled structural walls. If all the precast walls of the structure have the same

configuration and the same limiting engineering design criterion, then two modules shall be tested. Where intersecting precast wall systems are to be used, the response for the two orthogonal directions shall be tested.

14.2.4.5.2 Where the design requires the use of coupling elements, those elements shall be included as part of the test module.

14.2.4.5.3 Modules shall have a scale large enough to represent the complexities and behavior of the real materials and of the load transfer mechanisms in the prototype walls and their coupling elements, if any. Modules shall have a scale not less than one half and shall be full-scale if the validation testing has not been preceded by an extensive analytical and experimental development program in which critical details of connections are tested at full scale.

14.2.4.5.4 The geometry, reinforcing details, and materials properties of the walls, connections, and coupling elements shall be representative of those to be used in the prototype structure.

14.2.4.5.5 Walls shall be at least two panels high unless the prototype structure is one for which a single panel is to be used for the full height of the wall.

14.2.4.5.6 Where precast walls are to be used for bearing wall structures, as defined in ASCE/SEI 7-05, the test modules shall be subject during lateral loading to an axial load stress representative of that anticipated at the base of the wall in the prototype structure.

14.2.4.5.7 The geometry, reinforcing, and details used to connect the precast walls to the foundation shall replicate those to be used in the prototype structure.

14.2.4.5.8 Foundations used to support the test modules shall have geometric characteristics, and shall be reinforced and supported, so that their deformations and cracking do not affect the performance of the modules in a way that would be different than in the prototype structure.

14.2.4.6 Testing Agency. Testing shall be carried out by an independent testing agency approved by the Authority Having Jurisdiction. The testing agency shall perform its work under the supervision of a registered design professional experienced in seismic structural design.

14.2.4.7 Test Method

14.2.4.7.1 Test modules shall be subjected to a sequence of displacement-controlled cycles representative of the drifts expected under earthquake motions for the prototype structure. If the module consists of coupled walls, approximately equal drifts (within 5 percent of each other) shall be applied to the top of each wall and at each floor level. Cycles shall be to predetermined drift ratios as defined in Sections 14.2.4.7.2 through 14.2.4.7.6.

14.2.4.7.2 Three fully reversed cycles shall be applied at each drift ratio.

14.2.4.7.3 The initial drift ratio shall be within the essentially linear elastic response range for the module. See 14.2.4.7.11. Subsequent drift ratios shall be to values not less than 5/4 times, and not more than 3/2 times, the previous drift ratio.

14.2.4.7.4 For uncoupled walls, testing shall continue with gradually increasing drift ratios until the drift ratio in percent equals or exceeds the larger of : (a) 1.5 times the drift ratio corresponding to the design displacement or (b) the following value:

$$0.80 \leq 0.67 \left[h_w / l_w \right] + 0.5 \leq 2.5 \quad (14.2.4-1)$$

where h_w = height of entire wall for prototype structure (in inches) and l_w = length of entire wall in direction of shear force (in inches).

14.2.4.7.5 For coupled walls, h_w/l_w in Equation 14.2.4-1 shall be taken as the smallest value of h_w/l_w for any individual wall of the prototype structure.

14.2.4.7.6 Validation by testing to limiting drift ratios less than those given by Equation 14.2.4-1 shall be acceptable provided testing is conducted in accordance with this document to drift ratios equal or exceeding of those determined for the response to a suite of nonlinear time history analyses conducted in accordance with the 2009 *NEHRP Recommended Seismic Provisions* for risk-targeted maximum considered earthquake ground motions.

14.2.4.7.7 Actual yield strength of steel reinforcement shall be obtained by testing coupons taken from the same reinforcement batch as used in the test module. Two tests, conforming to the ASTM specifications cited in ACI 318 Section 3.8, shall be made for each reinforcement type and size.

14.2.4.7.8 Actual compressive strength of concrete shall be determined by testing of concrete cylinders cured under the same conditions as the test module and tested at the time of testing the module. Testing shall conform to the applicable requirements of ACI 318 Sections 5.6.1 through 5.6.4.

14.2.4.7.9 Where strength and deformation capacity of coupling devices does not depend on reinforcement tested as required in Section 14.2.4.7.7, the effective yield strength and deformation capacity of coupling devices shall be obtained by testing independent of the module testing.

14.2.4.7.10 Data shall be recorded from all tests such that a quantitative interpretation can be made of the performance of the modules. A continuous record shall be made of test module drift ratio versus applied lateral force, and photographs shall be taken that show the condition of the test module at the peak displacement and after each key testing cycle.

14.2.4.7.11 The effective initial stiffness of the test module shall be calculated based on test cycles to a force between $0.6E_{nt}$ and $0.9E_{nt}$, and using the deformation at the strength of $0.75E_{nt}$ to establish the stiffness.

14.2.4.8 Test Report

14.2.4.8.1 The test report shall contain sufficient evidence for an independent evaluation of all test procedures, design assumptions, and the performance of the test modules. As a minimum, all of the information required by Sections 14.2.4.8.1.1 through 14.2.4.8.1.11 shall be provided.

14.2.4.8.1.1 A description shall be provided of the design procedure and theory used to predict test module strength, specifically the test module nominal lateral resistance, E_n , and the test module actual lateral resistance E_{nt} .

14.2.4.8.1.2 Details shall be provided of test module design and construction, including fully dimensioned engineering drawings that show all components of the test specimen.

14.2.4.8.1.3 Details shall be provided of specified material properties used for design, and actual material properties obtained by testing in accordance with Section 14.2.4.7.7.

14.2.4.8.1.4 A description shall be provided of test setup, including fully dimensioned diagrams and photographs.

14.2.4.8.1.5 A description shall be provided of instrumentation, its locations, and its purpose.

14.2.4.8.1.6 A description and graphical presentation shall be provided of applied drift ratio sequence.

14.2.4.8.1.7 A description shall be provided of observed performance, including photographic documentation, of the condition of each test module at key drift ratios including, (as applicable), the ratios corresponding to first flexural cracking or joint opening, first shear cracking, and first crushing of the concrete for both positive and negative loading directions, and any other significant damage events that occur. Photos shall be taken at peak drifts and after the release of load.

14.2.4.8.1.8 A graphical presentation shall be provided of lateral force versus drift ratio response.

14.2.4.8.1.9 A graphical presentation shall be provided of relative energy dissipation ratio versus drift ratio.

14.2.4.8.1.10 A calculation shall be provided of effective initial stiffness for each test module as observed in the test and as determined in accordance with Section 14.2.4.7.11 and a comparison made as to how accurately the design procedure has been able to predict the measured stiffness. The design procedure shall be used to predict the overall structural response and a comparison made as to how accurately that procedure has been able to predict the measured response.

14.2.4.8.1.11 The test date, report date, name of testing agency, report author(s), supervising registered design professional, and test sponsor shall be provided.

14.2.4.9 Test Module Acceptance Criteria

14.2.4.9.1 The test module shall be deemed to have performed satisfactorily when all of the criteria Sections 14.2.4.9.1.1 through 14.2.4.9.1.3 are met for both directions of in-plane response. If any test module fails to pass the validation testing required by these provisions for any test direction, then the wall system has failed the validation testing.

14.2.4.9.1.1 Peak lateral strength obtained shall be at least $0.9E_{nt}$ and not greater than $1.2 E_{nt}$.

14.2.4.9.1.2 In cycling up to the drift level given by Sections 14.2.4.7.4 through 14.2.4.7.6, fracture of reinforcement or coupling elements, or other significant strength degradation, shall not occur. For a given direction, peak lateral strength during any cycle of testing to increasing displacement shall not be less than 0.8 times E_{max} for that direction.

14.2.4.9.1.3 For cycling at the given drift level for which acceptance is sought in accordance with Section 14.2.4.7.4, 14.2.4.7.5 or 14.2.4.7.6, as applicable, the parameters describing the third complete cycle shall have satisfied the following:

1. The relative energy dissipation ratio shall not be less than 1/8 and
2. The secant stiffness between drift ratios of -1/10 and +1/10 of the maximum applied drift shall not be less than 0.10 times the stiffness for the initial drift ratio specified in Section 14.2.4.7.3.

SECTION 14.4.5, MODIFICATIONS TO CHAPTER 1 OF ACI530/ASCE 5/TMS 402

Add the following new sections:

14.4.5.3 Plain (unreinforced) AAC masonry shear walls shall satisfy the requirements of Section 1.14.2.2.6 of ACI 530/ASCE 5/TMS 402.

14.4.5.4 Ordinary reinforced AAC masonry shear walls shall satisfy the requirements of Section 1.14.2.2.8 of ACI 530/ASCE 5/TMS 402.

Commentary to Chapter 14 Modifications

COMMENTARY TO SECTION 14.1.1

ASCE/SEI 7-05 included two different systems for both eccentrically braced frames (EBF) and buckling restrained braced frames (BRBF). The primary distinction between these two systems was whether or not there were moment resisting beam-column connections within the braced bays. However, testing at the University of California at Berkeley (Uriz and Mahin, 2004) has indicated designs that do not properly account for the stiffness and distribution of forces in braced frame connections may be subject to undesirable performance. This modification to ASCE/SEI 7-05 consolidates the EBF and BRBF building frame systems into a single designation with proper consideration of the beam-column connection demands.

This modification to ASCE/SEI 7-05 and the related changes to AISC 341-05 Sections 15.7 and 16.7 also allow the engineer either to:

1. Provide a fully restrained moment connection meeting the requirements for ordinary moment connections in AISC 341-05 and thereby directly providing a load path to resist the connection force and deformation demands or
2. Provide a connection with the ability to accommodate the potential rotation demands. An example of this would be a configuration tested at Lehigh University (Figure 1 of Fahnstock, et. al. 2006) that effectively formed a pinned condition in the beam just beyond the beam-column-brace connection.

COMMENTARY TO SECTION 14.1.4

C14.1.4 Cold-Formed Steel. This section adopts three standards by direct reference: AISI NAS, *North American Specification for the Design of Cold-Formed Steel Structural Members*, AISI S110, *Standard for Seismic Design of Cold-Formed Steel Structural Systems – Special Bolted Moment Frames*, and ASCE/SEI 8, *Specification for the Design of Cold Formed Stainless Steel Structural Members*.

Each document has specific limits of applicability. AISI NAS applies to the design of structural members that are cold-formed to shape from carbon or low-alloy steel sheet, strip, plate or bar not more than one-inch in thickness (AISI NAS, Section A1.1). Building on the requirements of AISI NAS, AISI S110 has additional special seismic design provisions for a newly designated seismic force resisting system entitled “cold-formed steel – special bolted moment frame (CFS-SBMF).” Finally, ASCE 8 governs the design of structural members that are cold-formed to shape from annealed and cold-rolled sheet, strip, plate, or flat bar stainless steels (ASCE 8, Section 1.1.1). All three documents focus on load-carrying members in buildings; however, allowances are made for applications in nonbuilding structures, if dynamic effects are appropriately considered.

Within AISI NAS and ASCE 8, there are requirements on the general provisions for the applicable types of steel; design of elements, members, structural assemblies, connections and joints; and mandatory testing. In addition, AISI NAS contains a chapter on the design of cold-formed steel structural members and connections undergoing cyclic loading. Both standards contain extensive commentaries for the benefit of the user.

C14.1.4.1.1 CFS-SBMF need to use the same-size beams and same-size columns throughout. In addition, the system needs to engage all primary columns, which support the roof or floor above, and those columns need to be supported on a level floor or foundation.

C14.1.4.1.2 These modifications were made for consistency with the test database.

C14.1.4.1.3 To be consistent with the test database (Uang and Sato, 2007), the limitations on both beam depth, steel grade, and surface treatment are added in Section D1.2.1 of AISI S110.

C14.1.4.1.4 To be consistent with the test database (Uang and Sato, 2007), the limitations on column depth, steel grade, and surface treatment are added in Section D1.2.2 of AISI S110. The width-thickness ratio was reduced based upon further review of the test specimens.

C14.1.4.1.5 AISI S110 is intended primarily for industrial platforms; however, the standard is not limited to these non-building structures and does not prohibit architectural attachments (such as partition walls). Therefore, the $0.05h$ drift limit in Section D1.3 of AISI S110 has been reduced to $0.03h$ to more closely align with the $0.025h$ drift limit of ASCE/SEI 7. The sentence, “In no case shall the design story drift exceed $0.05h$.” was added to ensure an absolute upper bound on the drift limit.

C14.1.4.2 Light-Framed Cold-Formed Construction. This subsection of cold-formed steel relates to light-framed construction, which is defined as a method of construction where the structural assemblies are formed primarily by a system of repetitive wood or cold-formed steel framing members or subassemblies of these members (ASCE/SEI 7, Section 11.2). Not only does this subsection repeat the direct adoptions of AISI NAS and ASCE 8, but it also allows the user to choose from an additional suite of standards that address different aspects of construction, including the following:

1. AISI GP, Standard for Cold-Formed Steel Framing – General Provisions, applies to the design, construction, and installation of structural and non-structural cold-formed steel framing members where the specified minimum base metal thickness is between 18 mils and 118 mils (AISI GP, Section A1).
2. AISI WSD, Standard for Cold-Formed Steel Framing – Wall Stud Design, applies to the design and installation of cold-formed steel studs for both structural and nonstructural walls in buildings (AISI WSD, Section A1).

COMMENTARY TO SECTION 14.2

C14.2 CONCRETE

The section adopts by reference ACI 318 for structural concrete design and construction. In addition, modifications to ACI 318 are made that are needed to coordinate the provisions of that material design standard with the provisions of ASCE/SEI 7. Work is ongoing to better coordinate the provisions of the two documents (ACI 318 and ASCE/SEI 7) such that the provisions in Section 14.2 will be significantly reduced in future editions of ASCE/SEI 7.

C14.2.2.2 ACI 318 Section 7.10. ACI 318 Section 7.10.5.6 prescribes reinforcement details for ties in compression members. Those details are appropriate for SDC A and B structures. This modification prescribes additional details for ties around anchor bolts in structures assigned to SDC C through F.

A wall pier is recognized as a separate category of structural element in this document but not ACI 318.

C14.2.2.3 Scope. This provision describes how the ACI 318 provisions should be interpreted for consistency with the ASCE/SEI 7 provisions.

C14.2.2.4 Intermediate Precast Structural Walls. ACI 318 Section 21.4 imposes requirements on precast walls for moderate seismic risk applications. Ductile behavior is to be ensured by yielding of the steel elements or reinforcement between panels or this provision requires the designer to determine the deformation in the connection corresponding to the earthquake design displacement, and then to check from experimental data that the connection type used can accommodate that deformation without significant strength degradation.

The wall pier requirements of Section 21.4.5 are patterned after the same requirements of Section 14.2.2.4 for wall piers that are part of structures in high seismic design categories. The 2006 Edition of the *International Building Code* restricts yielding to steel reinforcement only because of concern that steel elements in the body of a connection could fracture due to inelastic strain demands.

Several steel element connections have been tested under simulated seismic loading and the adequacy of their load-deformation characteristics and strain capacity have been demonstrated (Schultz and Magana, 1996). One such connection was used in the five-story building test that was part of the PRESSS Phase 3 research. The connection was used to provide

damping and energy dissipation, and demonstrated a very large strain capacity (Nakaki et al., 2001). Since then, several other steel element connections have been developed that can achieve similar results (Banks and Stanton), (Nakaki et al.). In view of these results, it is appropriate to allow yielding in steel elements that have been shown experimentally to have adequate strain capacity to maintain at least 80 percent of their yield force through the full design displacement of the structure.

C14.2.2.5 Wall Piers and Wall Segments. Wall piers are typically segments between openings in walls that are thin in the direction normal to the horizontal length of the wall. In current practice these elements are often not regarded as columns or as part of the structural walls. If not properly reinforced these elements are vulnerable to shear failure and that failure prevents the wall from developing the assumed flexural hinging. Section 21.9.10 is written to reduce the likelihood of a shear failure. Wall segments with a horizontal length-to-thickness ratio less than 2.5 are required to be designed as columns in compliance with Section 21.9 if they are utilized as part of the lateral-force-resisting system, even though the shortest cross-sectional dimension may be less than 12 in. in violation of Section 21.6.1.1. Such wall segments may be designed to comply with Section 21.13 if they are not utilized as part of the lateral-force-resisting system. Wall segments with a horizontal length-to-thickness ratio larger than or equal to 2.5, which do not meet the definition of wall piers (Section 14.2.2.2), must be designed as special structural walls or as portions of special structural walls in full compliance with Section 21.9 or 21.10.

C14.2.2.7 Foundations. The intention is that there should be no conflicts between the provisions of ACI 318 Section 21.12 and ASCE/SEI 7-05 Section 12.1.5, 12.13, or 14.2. However, the additional detailing requirements for concrete piles of Section 14.2.3 can result in conflicts with ACI 318 provisions if the pile is not fully embedded in the soil.

C14.2.2.8 Detailed Plain Concrete Walls. Design requirements for plain masonry walls have existed for many years and the corresponding type of concrete construction is the plain concrete wall. To allow the use of such walls as the lateral-force-resisting system in SDC A and B, this provision requires such walls to contain at least the minimal reinforcement specified in Section 22.6.7.2.

C14.2.2.9 Strength Requirements for Anchors. ACI 318 requires laboratory testing to establish the strength of anchor bolts greater than 2 in. in diameter or exceeding 25 in. in tensile embedment depth. This modification makes the ACI 318 equation giving the basic concrete breakout strength of a single anchor in tension in cracked concrete applicable irrespective of the anchor bolt diameter and tensile embedment depth.

Korean Power Engineering (KPE) has made tension tests on anchors with diameters up to 4.25 in. and embedment depths up to 45 in. and found that the diameter and embedment depth limits of ACI 318 Section D.4.2.2 for the design procedure for anchors in tension (Section D.5.2) can be eliminated. KPE also has conducted shear tests on anchors with diameters up to 3.0 in. and embedment depths as large as 30 in. and found no effect of the embedment depth on shear strength. However, the diameter tests showed that the basic shear breakout strength Equation D-24 needed some modification for the complete elimination of the 2 in. limit to be fully appropriate. Analytical work performed at the University of Stuttgart supports the need for some modification to Equation D-24. Changes consistent with the Korean and Stuttgart findings have already been made to the *FIB Design Guide* for anchors.

COMMENTARY TO SECTION 14.2.3

C14.2.3 Additional Detailing Requirements for Concrete Piles. Chapter 20 of the *PCI Bridge Design Manual* provides detailed information on the structural design of piles and on pile to cap connections for precast prestressed concrete piles. ACI 318 does not contain provisions governing the design and installation of portions of concrete piles, drilled piers, and caissons embedded in ground except for SDC D, E and F structures.

C14.2.3.1.2 Reinforcement for Uncased Concrete Piles (SDC C). The transverse reinforcing requirements in the potential plastic hinge zone of uncased concrete piles in Seismic Design Category C is a selective composite of two ACI 318 requirements. In the potential plastic hinge region of an intermediate moment-resisting concrete frame column, the transverse reinforcement spacing is restricted to the least of: (a) 8 times the diameter of the smallest longitudinal bar, (b) 24 times the diameter of the tie bar, (c) one-half the smallest cross-sectional dimension of the column, and (d) 12 in. Outside of the potential plastic hinge region of a special moment-resisting frame column, the transverse reinforcement spacing is restricted to the smaller of 6 times the diameter of the longitudinal column bars and 6 in.

C14.2.3.1.5 Reinforcement for Precast Nonprestressed Concrete Piles (SDC C). Transverse reinforcement requirements in and outside of the plastic hinge zone of precast nonprestressed piles are clarified. The transverse reinforcement requirement in the potential plastic hinge zone is a composite of two ACI 318 requirements (see Section C14.2.3.1.2). Outside of the potential plastic hinge region, the transverse reinforcement spacing is restricted to sixteen (16) times the longitudinal bar diameter. This should permit the longitudinal bars to reach compression yield before buckling. The maximum 8-in. tie spacing comes from current building code provisions for precast concrete piles.

C14.2.3.1.6 Reinforcement for Precast Prestressed Piles (SDC C). The transverse and longitudinal reinforcing requirements given in ACI 318, Chapter 21, were never intended for slender precast prestressed concrete elements and will result in unbuildable piles. These requirements are based on the *Recommended Practice for Design, Manufacture and Installation of Prestressed Concrete Piling* (PCI Committee on Prestressed Concrete Piling, 1993).

Equation 14.2.4-1, originally from ACI 318, has always been intended to be a lower-bound spiral reinforcement ratio for larger diameter columns. It is independent of the member section properties and can therefore be applied to large or small diameter piles. For cast-in-place concrete piles and precast prestressed concrete piles, the resulting spiral reinforcing ratios from this formula are considered to be sufficient to provide moderate ductility capacities (Fanous et al., 2007).

Full confinement per Equation 14.2.4-1 is required for the upper 20 feet of the pile length where curvatures are large. The amount is relaxed by 50 percent outside of that length in view of lower curvatures and in consideration of confinement provided by the soil.

C14.2.3.2.3 Reinforcement for Uncased Concrete Piles (SDC D through F). The reinforcement requirements for uncased concrete piles are taken from the 2006 IBC requirements, and should be adequate to provide ductility in the potential plastic hinge zones (Fanous et al., 2007).

C14.2.3.2.5 Reinforcement for Precast Concrete Piles (SDC D through F). The transverse reinforcement requirements for precast nonprestressed concrete piles are taken from the 2006 IBC requirements and are should be adequate to provide ductility in the potential plastic hinge zones (Fanous et al., 2007).

C14.2.3.2.6 Reinforcement for Precast-Prestressed Piles (SDC D through F). The reduced amounts of transverse reinforcement specified in this provision compared to those required for column members in ACI 318 are justified by the results of the study by Fanous et al., 2007. The last paragraph of the provision provides minimum transverse reinforcement requirements outside of the zone of prescribed ductile detailing.

COMMENTARY TO SECTION 14.2.4

C14.2.4 Acceptance Criteria for Special Precast Structural Walls Based on Validation Testing

C14.2.4.1 Notation. Symbols additional to those in ACI 318 Chapter 2 are defined:

- A_h = area of hysteresis loop.
- E_1, E_2 = peak lateral resistance for positive and negative loading, respectively, for third cycle of loading sequence.
- f_l = live load factor defined in Section 14.2.4.2.3.
- h_w = height of column of test module, in. or mm.
- K, K' = initial stiffness for positive and negative loading, respectively, for first cycle.
- θ_1, θ_2 = drift ratios at peak lateral resistance for positive and negative loading, respectively, for third cycle of loading sequence.
- θ_1', θ_2' = drift ratios for zero lateral load for unloading at stiffness K, K' from peak positive and negative lateral resistance, respectively, for third cycle of loading sequence.
- Δ = lateral displacement, in. or mm. See Figures C14.2.4.2.2-1, C14.2.4.2.2-2, and C14.2.4.2.2-3.
- Δ_a = allowable story drift, in. or mm. See Table 12.12-1 of ASCE/SEI 7-05.

C14.2.4.2 Definitions

C14.2.4.2.1 Coupling elements. Coupling elements are connections provided at specific intervals along the vertical boundaries of adjacent structural walls. Coupled structural walls are stiffer and stronger than the same walls acting independently. For cast-in-place construction effective coupling elements are typically coupling beams having small span-to-depth ratios. The inelastic behavior of such beams is normally controlled by their shear strength. For precast construction, effective coupling elements can be precast beams connected to the adjacent structural walls either by post-tensioning, ductile mechanical devices, or grouted-in-place reinforcing bars. The resultant coupled construction can be either emulative of cast-in-place construction or non-emulative (jointed). However, for precast construction coupling beams can also be omitted and mechanical devices used to connect directly the vertical boundaries of adjacent structural walls.

C14.2.4.2.2 Drift ratio. The definition of the drift ratio, θ , is illustrated in Figure C14.2.4.2.2-1 for a three panel wall module. The position of the module at the start of testing, with only its self-weight acting, is indicated by broken lines. The module is set on a horizontal foundation support that is centered at A and is acted on by a lateral force H applied at the top of the wall. The self-weight of the wall is distributed uniformly to the foundation support. However, under lateral loading, that self-weight and any axial gravity load acting at the top of the wall cause overturning moments on the wall that are additional

to the overturning moment Hh_w and can affect deformations. The chord AB of the centroidal axis of the wall is the vertical reference line for drift measurements.

For acceptance testing a lateral force H is applied to the wall through the pin at B. Depending on the geometric and reinforcement characteristics of the module that force can result in the module taking up any one, or a combination, of the deformed shapes indicated by solid lines in Figures C14.2.4.2.2-1, C14.2.4.2.2-2 and C14.2.4.2.2-3.

Figure C14.2.4.2.2-2 illustrates several possible components of the displacement Δ for a wall that is effectively solid while Figure C14.2.4.2.2-3 illustrates two possibly undesirable components of the displacement Δ . Regardless of the mode of deformation of the wall, the lateral force causes the wall at B to displace horizontally by an amount Δ . The drift ratio is the angular rotation of the wall chord with respect to the vertical and for the setup shown equals Δ / h_w where h_w is the wall height and is equal to the distance between the foundation support at A and the load point at B. Where prestressing steel is used in wall members, the stress f_{ps} in the reinforcement at the nominal and the probable lateral resistance shall be calculated in accordance with ACI 318 Section 18.7.

C14.2.4.2.3 Global toughness. These provisions describe acceptance criteria for special precast structural walls based on validation testing. The requirements of Section 21.1.1.8 of ACI 318 concerning toughness cover both to the energy dissipation of the wall system which, for monolithic construction, is affected primarily by local plastic hinging behavior and the toughness of the prototype structure as a whole. The latter is termed “global toughness” in these provisions and is a condition that does not apply to the walls alone. That global toughness requirement can be satisfied only through analysis of the performance of the prototype structure as a whole when the walls perform to the criteria specified in these provisions.

The required gravity load for global toughness evaluations is the value given by these provisions. For conformity with Section 9.2.1 of ACI 318-08, UBC 1997, IBC 2006 and NFPA 5000, the required gravity load is $1.2D + f_l L$ where the seismic force is additive to gravity forces and $0.9D$ where the seismic force counteracts gravity forces. D is the effect of dead loads, L is the effect of live loads, and f_l is a factor equal to 0.5 except for garages, areas occupied as places of public assembly, and all areas where the live load is greater than 100 psf (4.79 kN/m²) where f_l equals 1.0.

C14.2.4.2.5 Relative energy dissipation ratio. This concept is illustrated in Figure C14.2.4.2.2-1 for the third loading cycle to the limiting drift ratio required by Section 14.2.4.7.4, 14.2.4.7.5 or 14.2.4.7.6, as appropriate.

Figure 14.2.4.2.2-2 illustrates several possible components of the displacement Δ for a wall that is effectively solid while Figure C14.2.4.2.2-3 illustrates two possibly undesirable components of the displacement Δ . Regardless of the mode of deformation of the wall, the lateral force causes the wall at B to displace horizontally by an amount Δ . The drift ratio is the angular rotation of the wall chord with respect to the vertical and for the setup shown equals Δ / h_w where h_w is the wall height and is equal to the distance between the foundation support at A and the load point at B.

Where prestressing steel is used in wall members, the stress f_{ps} in the reinforcement at the nominal and the probable lateral resistance shall be calculated in accordance with Section 18.7 of ACI 318.

C14.2.4.2.3 Global toughness. These provisions describe acceptance criteria for special precast structural walls based on validation testing. The requirements of ACI 318 Section 21.1.1.8 concerning toughness cover both to the energy dissipation of the wall system which, for monolithic construction, is affected primarily by local plastic hinging behavior and the toughness of the prototype structure as a whole. The latter is termed “global toughness” in these provisions and is a condition that does not apply to the walls alone. That global toughness requirement can be satisfied only through analysis of the performance of the prototype structure as a whole when the walls perform to the criteria specified in these provisions.

The required gravity load for global toughness evaluations is the value given by these provisions. For conformity with Section 9.2.1 of ACI 318-08, UBC 1997, IBC 2006 and NFPA 5000, the required gravity load is $1.2D + f_l L$ where the seismic force is additive to gravity forces and $0.9D$ where the seismic force counteracts gravity forces. D is the effect of dead loads, L is the effect of live loads, and f_l is a factor equal to 0.5 except for garages, areas occupied as places of public assembly, and all areas where the live load is greater than 100 psf (4.79 kN/m²) where f_l equals 1.0.

C14.2.4.2.5 Relative energy dissipation ratio. This concept is illustrated in Figure C14.2.4.2.5 for the third loading cycle to the limiting drift ratio required by Section 14.2.4.7.4, 14.2.4.7.5 or 14.2.4.7.6, as appropriate. For Figure C14.2.4.2.5, it is assumed that the test module has exhibited different initial stiffnesses, K and K' , for positive and negative lateral forces and that the peak lateral resistances for the third cycle for the positive and negative loading directions, E_1 and E_2 , also differ. The area of the hysteresis loop for the third cycle, A_n , is hatched. The circumscribing figure consists of two parallelograms, ABCD and DFGA. The slopes of the lines AB and DC are the same as the initial stiffness, K , for positive loading and the slopes of the lines DF and GA are the same as the initial stiffness, K' , for negative loading. The relative energy dissipation ratio concept is similar to the equivalent damping concept used in Section 17.8.3 of the ASCE/SEI 7-05 for required tests of seismic isolation systems.

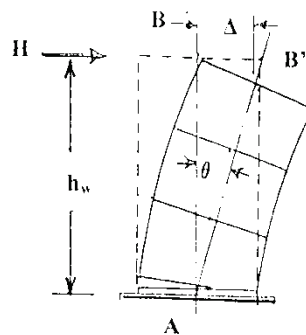

Figure C14.2.4.2.2-1 Definition of drift ratio θ .

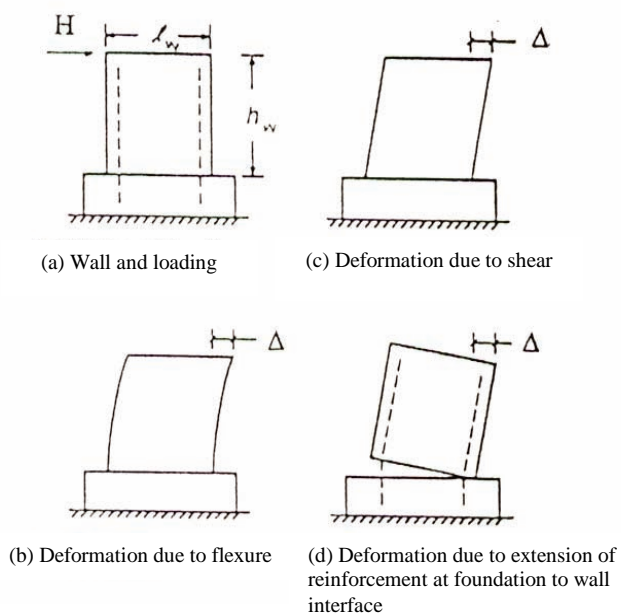

Figure C14.2.4.2.2-2 Typical wall deformation components.

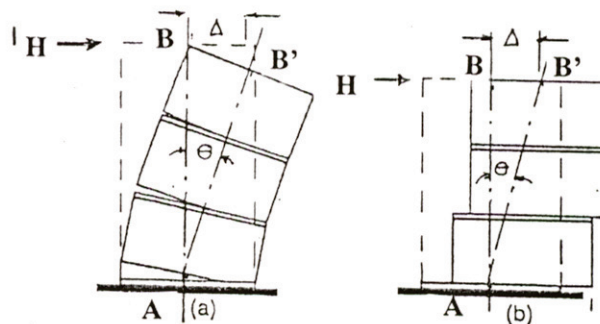

Figure C14.2.4.2.2-3 Undesirable deformations along horizontal joints: (a) excessive gap opening between panels and (b) shear slip.

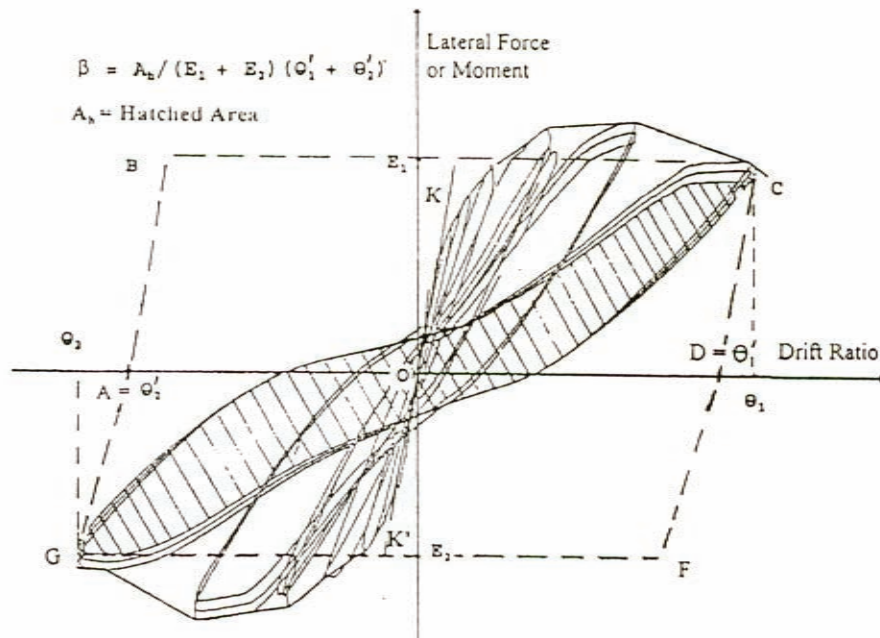

Figure C14.2.4.2.5 Relative energy dissipation ratio.

For a given cycle the relative energy dissipation ratio, β , is the area, A_n , inside the lateral force-drift ratio loop for the module, divided by the area of the effective circumscribing parallelograms ABCD and DFGA. The areas of the parallelograms equal the sum of the absolute values of the lateral force strengths, E_1 and E_2 , at the drift ratios θ_1 and θ_2 multiplied by the sum of the absolute values for the drift ratios θ_1' and θ_2' .

C14.2.4.3 Scope and general requirements. While only ACI Committee 318 can determine the requirements necessary for precast walls to meet the provisions of ACI 318 Section 21.1.1.8, ACI 318 Section 1.4 already permits the building official to accept wall systems, other than those explicitly covered by ACI 318 Chapter 21, provided specific tests, load factors, deflection limits, construction procedures and other pertinent requirements have been established for acceptance of such systems consistent with the intent of the code. The purpose of these provisions is to provide a framework that establishes the specific tests, load factors, deflection limits and other pertinent requirements appropriate for acceptance, for regions of high seismic risk or for structures assigned to high seismic performance or design categories, of precast wall systems, including coupled wall systems, not satisfying all the requirements of ACI 318 Chapter 21. For regions of moderate seismic risk or for structures assigned to intermediate seismic performance or design categories, less stringent provisions than those specified here are appropriate.

These provisions assume that the precast wall system to be tested has details differing from those prescribed by ACI 318 Section 21.9 for conventional monolithic reinforced concrete construction. Such walls may, for example, involve the use of precast elements, precast prestressed elements, post-tensioned reinforcement, or combinations of those elements and reinforcement.

For monolithic reinforced concrete walls a fundamental design requirement of ACI 318 Chapter 21 is that walls with h_w/l_w exceeding 1.0 be proportioned so that their inelastic response is dominated by flexural action on a critical section located near the base of the wall. That fundamental requirement is retained in these provisions. The reason is that tests on modules, as envisioned in these provisions, cannot be extrapolated with confidence to the performance of panelized walls of proportions differing from those tested for the development of ACI 318 Chapter 21 if the shear-slip displacement pattern of Figure C14.2.4.2.2.3, or the shear deformation response of Figure C14.2.4.2.2.2, governs the response developed in the test on the module. Two other fundamental requirements of ACI 318 Chapter 21 are for ties around heavily strained boundary element reinforcement and the provision of minimum amounts of uniformly distributed horizontal and vertical reinforcement in the web of the wall. Ties around boundary element reinforcement to inhibit its buckling in compression are required where the strain in the extreme compression fiber is expected to exceed some critical value. Minimum amounts of uniformly distributed horizontal and vertical reinforcement over the height and length of the wall are required to restrain the opening of inclined

cracks and allow the development of the drift ratios specified in Sections 14.2.4.7.4, 14.2.4.7.5 and 14.2.4.7.6. Deviations from those tie and distributed reinforcement requirements are possible only if a theory is developed that can substantiate reasons for such deviations and that theory is tested as part of the validation testing.

C14.2.4.3.1. These provisions are not intended for use with existing construction or for use with walls that are designed to conform to all the requirements of ACI 318 Section 21.9. The criteria of these provisions are more stringent than those for walls designed to ACI 318 Section 21.9. Some walls designed to Section 21.9, and having low height to length ratios, may not meet the drift ratio limits of Equation 14.2.4-1 because their behavior may be governed by shear deformations. The height to length ratio of 0.5 is the least value for which Equation 14.2.4-1 is applicable.

C14.2.4.3.3 For acceptance, the results of the tests on each module must satisfy the acceptance criteria of Section 14.2.4.9. In particular, the relative energy dissipation ratio calculated from the measured results for the third cycle between the specified limiting drift ratios must equal or exceed 1/8. For uncoupled walls, relative energy dissipation ratios increase as the drift ratio increases. Tests on slender monolithic walls have shown relative energy dissipation ratios, derived from rotations at the base of the wall, of about 40-45 percent at large drifts. The same result has been reported even where there has been a significant opening in the web of the wall on the compression side. For 0.020 drift ratios and walls with height to length ratios of 4, relative energy dissipation ratios have been computed as 30, 18, 12, and 6 percent, for monolithic reinforced concrete, hybrid reinforced/post-tensioned prestressed concrete with equal flexural strengths provided by the prestressed and deformed bar reinforcement, hybrid reinforced/post-tensioned prestressed concrete with 25 percent of the flexural strength provided by deformed bar reinforcement and 75 percent by the prestressed reinforcement, and post-tensioned prestressed concrete special structural walls, respectively. Thus, for slender precast uncoupled walls of emulative or non-emulative design it is to be anticipated that at least 35 percent of the flexural capacity at the base of the wall needs to be provided by deformed bar reinforcement if the requirement of a relative energy dissipation ratio of 1/8 is to be achieved. However, if more than about 40 percent of the flexural capacity at the base of the wall is provided by deformed bar reinforcement, then the self-centering capability of the wall following a major event is lost and that is one of the prime advantages gained with the use of post-tensioning. For squat walls with height to length ratios between 0.35 and 0.69 the relative energy dissipation has been reported as remaining constant at 23 percent for drifts between that for first diagonal cracking and that for a post-peak capacity of 80 percent of the peak capacity. Thus, regardless of whether the behavior of a wall is controlled by shear or flexural deformations a minimum relative energy dissipation ratio of 1/8 is a realistic requirement.

For coupled wall systems, theoretical studies and tests have demonstrated that the 1/8 relative energy dissipation ratio can be achieved by using central post-tensioning only in the walls and appropriate energy dissipating coupling devices connecting adjacent vertical wall boundaries.

C14.2.4.3.3.4. The ASCE/SEI 7-05 allowable story drift limits are the basis for the drift limits of IBC 2006 and NFPA 5000. Allowable story drifts, Δ_a , are specified in Table 1617.3 of IBC 2006 and likely values are discussed in the Commentary to Section 14.2.4.7.4. The limiting initial drift ratio consistent with Δ_a equals $\Delta_a/\phi C_d h_w$, where ϕ is the strength reduction factor appropriate to the condition, flexure or shear, that controls the design of the test module. For example, for Δ_a/h_w equal to 0.015, the required deflection amplification factor C_d of 5, and ϕ equal to 0.9, the limiting initial drift ratio, corresponding to B in Figure C14.2.4.9.1, is 0.0033. The use of a ϕ value is necessary because the allowable story drifts of the IBC are for the design seismic load effect, E , while the limiting initial drift ratio is at the nominal strength, E_n , which must be greater than E/ϕ . The load-deformation relationship of a wall becomes significantly non-linear before the applied load reaches E_n . While the load at which that non-linearity becomes marked depends on the structural characteristics of the wall, the response of most walls remains linear up to about 75 percent of E_n .

C14.2.4.3.3.5. The criteria of Section 14.2.4.9 are for the test module. In contrast, the criterion of Section 14.2.4.3.3.5 is for the structural system as a whole and can be satisfied only by the philosophy used for the design and analysis of the building as a whole. The criterion adopted here is similar to that described in the last paragraph of R21.1.1 of ACI 318 and the intent is that test results and analyses demonstrate that the structure, after cycling three times through both positive and negative values of the limiting drift ratio specified in Section 14.2.4.7.4, 14.2.4.7.5 or 14.2.4.7.6, as appropriate, is still capable of supporting the gravity load specified as acting on it during the earthquake.

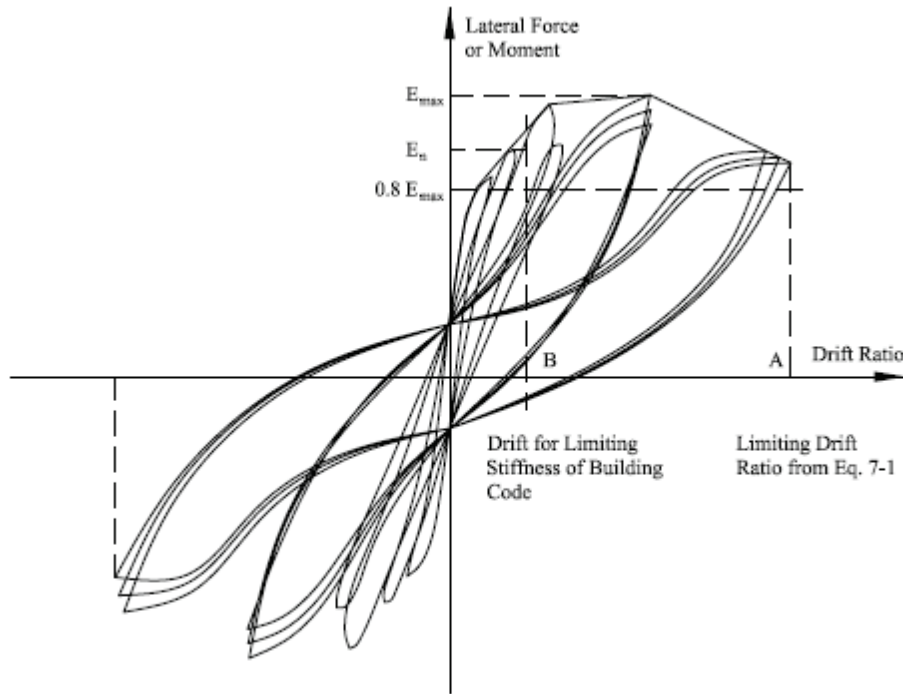

Figure C14.2.4.9.1 Quantities used in evaluating acceptance criteria.

C14.2.4.4 Design Procedure.

C14.2.4.4.1. The test program specified in these provisions is intended to verify an existing design procedure for precast structural walls for a specific structure or for prequalifying a generic type of special precast wall system for construction in general. The test program is not for the purpose of creating basic information on the strength and deformation properties of such systems for design purposes. Thus, the test modules should not fail during the validation testing, a result that is the opposite of what is usually necessary during testing in the development phase for a new or revised design procedure. For a generic precast wall system to be accepted based on these provisions, a rational design procedure is to have been developed prior to this validation testing. The design procedure is to be based on a rational consideration of material properties and force transfer mechanisms, and its development will usually require preliminary and possibly extensive physical testing that is not part of the validation testing. Because special wall systems are likely to respond inelastically during design-level ground shaking, the design procedure must consider wall configuration, equilibrium of forces, compatibility of deformations, the magnitudes of the lateral drifts, reversed cyclic displacements, the relative values of each limiting engineering design criteria (shear, flexure and axial load) and use appropriate constitutive laws for materials that include considerations of effects of cracking, loading reversals and inelasticity.

The effective initial stiffness of the structural walls is important for calculating the fundamental period of the prototype structure. The procedure used to determine the effective initial stiffness of the walls is to be verified from the validation test results as described in Section 14.2.4.7.11.

Provisions Sections 14.2.4.4.1.1 through 14.2.4.4.1.3 state the minimum procedures to be specified in the design procedure prior to the start of testing. The Authority Having Jurisdiction may require that more details be provided in the design procedure than those of Sections 14.2.4.4.1.1 through 14.2.4.4.1.3 prior to the start of testing.

C14.2.4.4.2. The justification for the small number of test modules, specified in Section 14.2.4.5.1 is that a previously developed rational design procedure is being validated by the test results. Thus, the test modules for the experimental program must be designed using the procedure intended for the prototype wall system and strengths must be predicted for the test modules before the validation testing is started.

C14.2.4.5 Test Modules.

C14.2.4.5.1. One module must be tested for each limiting engineering design criterion, such as shear, or axial load and flexure, for each characteristic configuration of walls. Thus, in accordance with Section 14.2.4.4.3 if the test on the module results in a maximum shear stress of $3\sqrt{f'_c}$, then the maximum shear stress that can be used in the prototype is that same value. Each characteristic in-plane configuration of walls, or coupled walls, in the prototype structure must also be tested. Thus, as a minimum for one-way structural walls, two modules with the configuration shown in Figure C14.2.4.2.2-1, and, for one way coupled walls, two modules with the configuration shown in either Figure C14.2.4.5.1(a) or in Figure C14.2.4.5.1(b), must be tested. In addition, if intersecting wall systems are to be used then the response of the wall systems for the two orthogonal directions needs to be tested. For two-way wall systems and coupled wall-frame systems, testing of configurations other than those shown in Figures C14.2.4.2.2-1 and C14.2.4.5.1 may be appropriate when it is difficult to realistically model the likely dominant earthquake deformations using orthogonal direction testing only.

This provision should not be interpreted as implying that only two tests will need to be made to qualify a generic system. During the development of that system it is likely that several more tests will have been made, resulting in progressive refinements of the mathematical model used to describe the likely performance of the generic structural wall system and its construction details. Consequently, only one test of each module type for each limiting engineering design condition, at a specified minimum scale and subjected to specific loading actions, may be required to validate the system. Further, as stated in Section 14.2.4.9.1, if any one of those modules for the generic wall system fails to pass the validation testing required by these provisions, then the generic wall system has failed the validation testing

In most prototype structures, a slab is usually attached to the wall and, as demonstrated by the results of the PRESSS building test, the manner in which the slab is connected to the wall needs to be carefully considered. The connection needs to be adequate to allow the development of story drifts equal to those anticipated in these provisions. However, in conformity with common practice for the sub-assembly tests used to develop the provisions of Chapter 21 of ACI 318, there is no requirement for a slab to be attached to the wall of the test module. The effect of the presence of the slab should be examined in the development program that precedes the validation testing.

C14.2.4.5.3. Test modules need not be as large as the corresponding walls in the prototype structure. The scale of the test modules, however, must be large enough to capture all the complexities associated with the materials of the prototype wall, its geometry and reinforcing details, load transfer mechanisms, and joint locations. For modules involving the use of precast elements, for example, scale effects for load transfer through mechanical connections should be of particular concern. The issue of the scale necessary to capture fully the effects of details on the behavior of the prototype should be examined in the development program that precedes the validation testing.

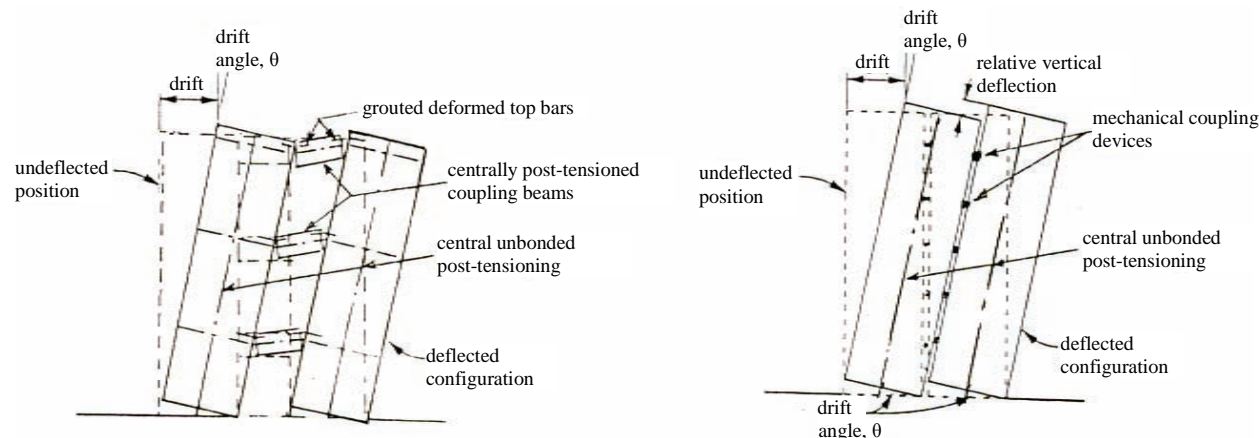

**Figure C14.2.4.5.1 (a) Coupled wall test module with coupling beams;
(b) Coupled wall test module with vertical mechanical couplers.**

C14.2.4.5.4. It is to be expected that for a given generic precast wall structure, such as an unbonded centrally post-tensioned wall constructed using multiple precast or precast pretensioned concrete wall panels, validation testing programs will initially use specific values for the specified strength of the concrete and reinforcement in the walls, the layout of the connections between panels, the location of the post-tensioning, the location of the panel joints, and the design stresses in the wall. Pending the development of an industry standard for the design of such walls, similar to the standard for special hybrid

moment frames, specified concrete strengths, connection layouts, post-tensioning amounts and locations, etc., used for such walls will need to be limited to the values and layouts used in the validation testing programs.

C14.2.4.5.5. For walls constructed using precast or precast/prestressed panels and designed using non-emulative methods, the response under lateral load can change significantly with joint opening (Figure C14.2.4.2.2-2d and Figure C14.2.4.2.2-3a). The number of panels used to construct a wall depends on wall height and design philosophy. If, in the prototype structure, there is a possibility of horizontal joint opening under lateral loading at a location other than the base of the wall, then the consequences of that possibility need to be considered in the development and validation test programs. Joint opening at locations other than the base can be prevented through the use of capacity design procedures.

C14.2.4.5.6. The significance of the magnitude of the gravity load that acts simultaneously with the lateral load needs to be addressed during the validation testing if the development program suggests that effect is significant.

C14.2.4.5.7. Details of the connection of walls to the foundation are critical, particularly for non-emulative wall designs. The deformations that occur at the base of the wall due to plastic hinging or extension of the reinforcing bars or post-tensioning steel crossing the wall to foundation interface, (Figure C14.2.4.2.2-2d), are in part determined by details of the anchorage and the bonding of those reinforcements on either side of the interface. Grout will be normally used to bed panels on the foundation and the characteristics of that grout in terms of materials, strength and thickness, can have a large effect on wall performance. The typical grout pad with a thickness of 1 inch (25 mm) or less can be expected to provide a coefficient of friction of about 0.6 under reversed loadings. Pads with greater thickness and without fiber reinforcement exhibit lesser coefficients of friction. Adequate frictional resistance is essential to preventing undesirable shear-slip deformations of the type shown in Figure C14.2.4.2.2.3(b).

C14.2.4.5.8. The geometry of the foundations need not duplicate that used in the prototype structure. However, the geometric characteristics of the foundations (width, depth and length) need to be large enough that they do not influence the behavior of the test module.

C14.2.4.6 Testing Agency. In accordance with the spirit of the requirements of Sections 1.3.5 and 1.4 of ACI 318, it is important that testing be carried out by a recognized independent testing agency, approved by the agency having jurisdiction and that the testing and reporting be supervised by a registered design professional familiar with the proposed design procedure and experienced in testing and seismic structural design.

C14.2.4.7 Test Method. The test sequence is expressed in terms of drift ratio, and the initial ratio is related to the likely range of linear elastic response for the module. That approach, rather than testing at specific drift ratios of 0.005, 0.010, etc., is specified because, for modules involving prestressed concrete, the likely range of elastic behavior varies with the prestress level.

An example of the test sequence specified in Sections 14.2.4.7.2 through 14.2.4.7.6 is illustrated in Figure C14.2.4.7. The sequence is intended to ensure that displacements are increased gradually in steps that are neither too large nor too small. If steps are too large, the drift capacity of the system may not be determined with sufficient accuracy.

If the steps are too small, the system may be unrealistically softened by loading repetitions, resulting in artificially low maximum lateral resistances and artificially high maximum drifts. Also, when steps are too small, the rate of change of energy stored in the system may be too small compared with the change occurring during a major event. Results, using such small steps, can mask undesirable brittle failure modes that might occur in the inelastic response range during a major event. Because significant diagonal cracking is to be expected in the inelastic range in the web of walls, and in particular in squat walls, the pattern of increasing drifts used in the test sequence can markedly affect diagonal crack response in the post-peak range of behavior.

The drift capacity of a building in a major event is not a single quantity, but depends on how that event shakes the structure. In the forward near field, a single pulse may determine the maximum drift demand, in which case a single large drift demand cycle for the test module would give the best estimation of the drift capacity. More often, however, many small cycles precede the main shock and that is the scenario represented by the specified loading.

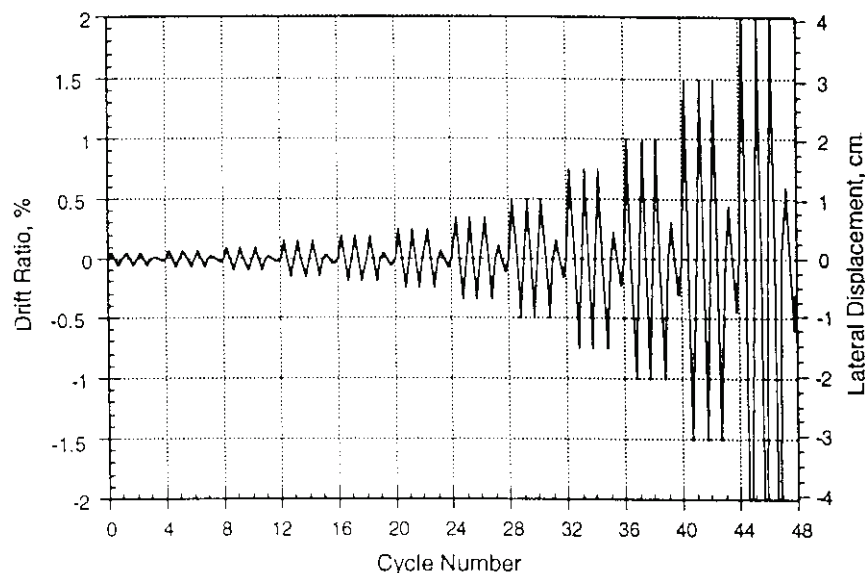

Figure C14.2.4.7 Example of specified test sequence.

There is no requirement for an axial load to be applied to the wall simultaneously with the application of the lateral displacements. In many cases it will be conservative not to apply axial load because, in general, the shear capacity of the wall and the resistance to slip at the base of the wall increase as the axial load on the wall increases. However, as the height of the wall increases and the limiting drift utilized in the design of the wall increases, the likelihood of extreme fiber crushing in compression at maximum drift increases, and the importance of the level of axial load increases. The significance of the level of axial loading should be examined during the development phase.

C14.2.4.7.4 For the response of a structure to the design seismic shear force, building codes (e.g., UBC 97, IBC 2006 or NFPA 5000) or recommended provisions (e.g., ASCE/SEI 7-05 and FEMA 356) specify a maximum allowable drift. However, structures designed to meet that drift limit may experience greater drifts under the design basis earthquake ground motion and are likely to experience greater drifts under the risk-targeted maximum considered earthquake ground motion. In addition to the characteristics of the ground motion, actual drifts will depend on the strength of the structure, its initial elastic stiffness, and the ductility expected for the given lateral load resisting system. Specification of suitable limiting drifts for the test modules requires interpretation and allowance for uncertainties in the assumed ground motions and structural properties.

In IBC 2006, the design seismic shear force applied at the base of a building is related directly to its weight and the design elastic response acceleration, and inversely to a response modification factor, R . That R factor increases with the expected ductility of the lateral force resisting system of the building. Special structural walls satisfying the requirements of Sections 21.1 and 21.9 are assigned an R value of 6 when used in a building frame system and a value of 5 when used in a bearing wall system. They are also assigned allowable story drift ratios that are dependent on the hazard to which the building is exposed. When the design seismic shear force is applied to a building, the building responds inelastically and the resultant computed drifts, (the design story drifts), must be less than a specified allowable drift. Additional guidance is given in FEMA 356 where the deformations for rectangular walls with height to length ratios greater than 2.5, and flanged wall sections with height to length ratios greater than 3.5, are to be assumed to be controlled by flexural actions. When structural walls are part of a building representing a substantial hazard to human life in the event of a failure, the allowable story drift ratio for shear controlled walls is 0.0075 and for flexure controlled walls is a function of the plastic hinge rotation at the base of the wall. For flexure controlled walls values range up to a maximum of about 0.02 for walls with confined boundary elements with low reinforcement ratios and shear stress less than $3\sqrt{f'_c}$.

To compensate for the use of the R value, IBC Section 1617.4.6 requires that the drift determined by an elastic analysis for the code-prescribed seismic forces be multiplied by a deflection amplification factor, C_d , to determine the design story drift and that the design story drift must be less than the allowable story drift. In building frame systems, structural walls satisfying the requirements of Section 21.9 of ACI 318 are assigned a C_d value of 5. However, research has found that design story drift ratios determined in the foregoing manner may be too low. Drift ratios of 6 times IBC-calculated values, (rather

than 5), are more representative of the upper bounds to expected drift ratios. The value of 6 is also in agreement with the finding that the drift ratio of an inelastic structure is approximately the same as that of an elastic structure with the same initial period. For flexure controlled walls the value of 6/5 times the present IBC limits on calculated drift ratio, would lead to a limit on real drift ratios of up to 0.024.

Duffy et al. reviewed experimental data for shear walls to define post-peak behavior and limiting drift ratios for walls with height to length ratios between 0.25 and 3.5. Seo et al. re-analyzed the data of Duffy et al. together with data from tests conducted subsequent to the analysis of Duffy et al. Duffy et al. established that for squat walls with web reinforcement satisfying ACI 318-02 requirements and height to length ratios between 0.25 and 1.1, there was a significant range of behavior for which drifts were still reliable in the post-peak response region. Typically the post-peak drift increased by 0.005 for a 20 percent degradation in capacity under cyclic loading. For greater values of degradation, drifts were less reliable. That finding has also been confirmed through tests conducted by Hidalgo et al. (2002) on squat walls with effective height to length ratios ranging between 0.35 and 1.0. Values of the drift ratio of the walls at inclined cracking and at peak capacity varied little with web reinforcement. By contrast, drifts in the post-peak range were reliable to a capacity equal to 80 percent of the peak capacity and were 0.005 greater than the drifts at peak capacity provided the walls contained horizontal and vertical web reinforcement equal to 0.25 percent.

From an analysis of the available test data, and from theoretical considerations for a wall rotating flexurally about a plastic hinge at its base, Seo et al. concluded that the limiting drift at peak capacity increased almost linearly with the height to length ratio of the wall. When the additional post peak drift capacity for walls with adequate web reinforcement was added to the drift at peak capacity, the total available drift capacity in percent was given by $1.0 \leq 0.67 (h_w/l_w) + 0.5 \leq 3.0$ where h_w is the height of the wall, and l_w is the length of the wall.

The data from the tests of Hidalgo et al. (2002) suggest that while that formula is correct for squat walls, the lower limit on drift can be decreased to 0.8 as specified in these provisions and that the use of that formula should be limited to walls with height to length ratios equal to or greater than 0.5. For wall height to length ratios less than 0.5, the behavior is controlled principally by shear deformations (Figure C14.2.4.2.2.2c), and Equation 14.2.4-1 should not be used. The upper value of 0.030 for the drift ratio was somewhat optimistic because the data were for walls with height to length ratios equal to or less than 3.5 and subsequent tests have shown that the upper limit of 2.5, as specified in Equation 14.2.4.1, is a more realistic limit.

C14.2.4.7.5 The design capacity for coupled wall systems must be developed by the drift ratio corresponding to that for the wall with the least h_w/l_w value. However, it is desirable that testing be continued to the drift given by Equation 14.2.4-1 for the wall with the greatest h_w/l_w in order to assess the reserve capacity of the coupled wall system.

C14.2.4.7.6 The drift limits of Equation 14.2.4.1 are representative of the maximum that can be achieved by walls designed to ACI 318. The use of smaller drift limits is appropriate if the designer wishes to use performance measures less than the maximum permitted by ACI 318. Examples are the use of reduced shear stresses so that the likelihood of diagonal cracking of the wall is minimized or reduced compressive stresses in the boundary elements of the wall so that the risk of crushing is reduced. Nonlinear time history analyses for the response to a suite of risk-targeted maximum considered earthquakes (MCE_R) ground motions, rather than 1.5 times a suite of the corresponding design basis earthquake (DBE) ground motions, is required because the drifts for the response to the MCE_R motion can be significantly larger than 1.5 times the drifts for the response to the DBE motions.

C14.2.4.7.10 In many cases, data additional to the minimum specified in Section 14.2.4.7.7 may be useful to confirm both design assumptions and satisfactory response. Such data include relative displacements, rotations, curvatures, and strains.

C14.2.4.8 Test Report. The test report must be sufficiently complete and self-contained for a qualified expert to be satisfied that the tests have been designed and carried out in accordance with these criteria, and that the results satisfy the intent of these provisions. Sections 14.2.4.8.1.1 through 14.2.4.8.1.11 state the minimum evidence to be contained within the test report. The authority having jurisdiction or the registered design professional supervising the testing may require that additional test information be reported.

C14.2.4.9 Test Module Acceptance Criteria.

The requirements of this clause apply to each module of the test program and not to an average of the results of the program. Figure C14.2.4.9.1 illustrates the intent of this clause.

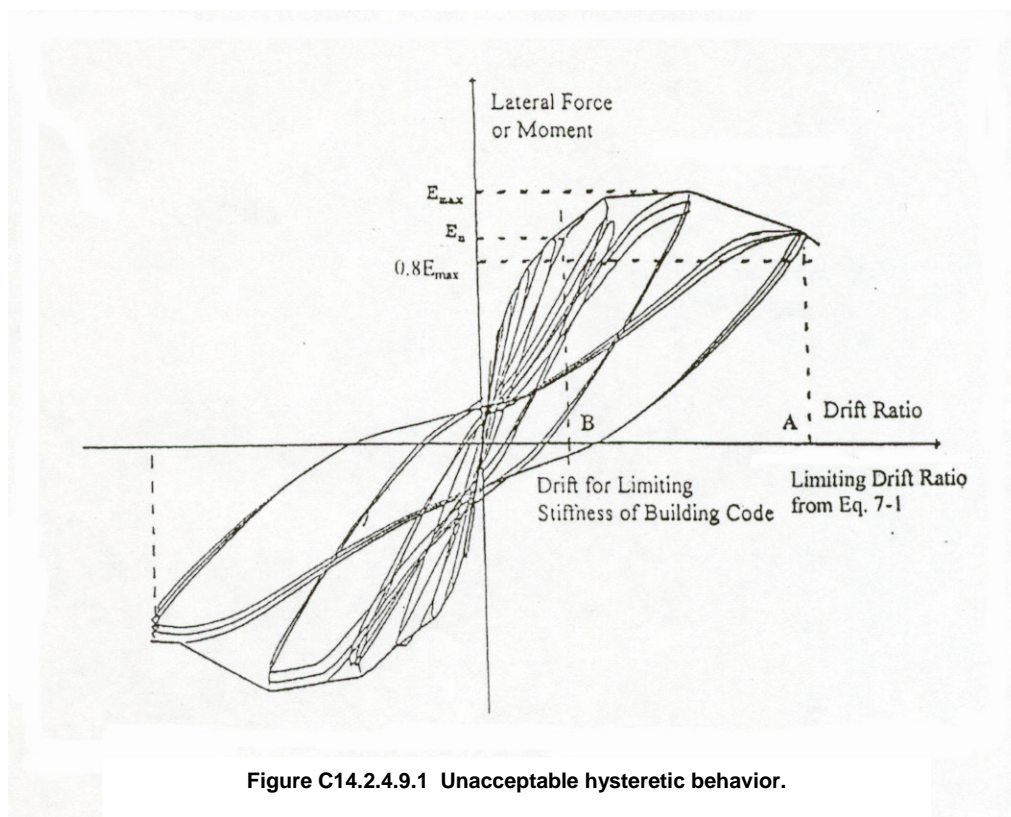

Figure C14.2.4.9.1 Unacceptable hysteretic behavior.

C14.2.4.9.1.1 Where nominal strengths for opposite loading directions differ, as is likely for C-, L- or T- shaped walls, the criterion of Section 14.2.4.9.1.1 applies separately to each direction.

C14.2.4.9.1.2 At high cyclic-drift ratios, strength degradation is inevitable. To limit the level of degradation so that drift ratio demands do not exceed anticipated levels, a maximum strength degradation of $0.20E_{max}$ is specified. Where strengths differ for opposite loading directions, this requirement applies independently to each direction.

C14.2.4.9.1.3. If the relative energy dissipation ratio is less than $1/8$, there may be inadequate damping for the building as a whole. Oscillations may continue for some time after an earthquake, producing low-cycle fatigue effects, and displacements may become excessive.

If the stiffness becomes too small around zero drift ratio, the structure will be prone to large displacements for small lateral force changes following a major earthquake. A hysteresis loop for the third cycle between peak drift ratios of $1/10$ times the limiting drift ratio given by Equation 14.2.4-1, that has the form shown in Figure C14.2.4.9.1, is acceptable. At zero drift ratio, the stiffnesses for positive and negative loading are about 11 percent of the initial stiffnesses. Those values satisfy Section 14.2.4.9.1. An unacceptable hysteresis loop form would be that shown in Figure C14.2.4.9.1 where the stiffness around zero drift ratio is unacceptably small for both positive and negative loading.

COMMENTARY TO SECTION 14.4.5

C14.4.5 Modifications to Chapter 1 of ACI 530/ASCE 5/TMS 402. The seismic design factors, SDC limits, and height restrictions of these provisions are based on a combination of testing, analysis, underlying consensus standards, experience, and consistency with comparable structural systems.

The testing and analysis, described in Tanner et al. (2005a and b) and Varela et al. (2005b), began in 1999 and were developed as part of an integrated research strategy. This strategy, presented at ICC-ES hearings in 2003 and affirmed in its essence using performance-based methods similar to those in the 90-percent-complete draft of FEMA P-695 (Applied Technology Council, 2008), had as its objective the development of seismic design factors consistent with at most a 10 percent probability of collapse under what was essentially equivalent to the maximum considered earthquake ground motion. That research developed factors of R and C_d equal to 3 with no restrictions on SDC or height. Additional information on that research is presented in American Society of Testing and Materials (2007), Masonry Standards Joint Committee (2005a and b and 2008a and b), The Masonry Society (2007), Tanner et al. (2005a and b), and Varela et al. (2006).

Following the initial presentation of this strategy and its associated proposals in the ICC-ES forum, it was discussed extensively with the BSSC's Provisions Update Committee and other interested parties including the BSSC's Code Resource Support Committee. Those discussions led to a modification of the proposal to R and C_d factors equal to 2, to SDC from A to C, and to height restrictions of 35 ft for SDC C. These values and their associated restrictions are consistent with a probability of failure much lower than 10 percent under what was essentially equivalent to the risk-targeted maximum considered earthquake ground motion (MCE_R).

Structures of autoclaved aerated concrete (AAC) masonry are designed and constructed using U.S. consensus standards including material standards (American Society of Testing and Materials, 2007), design provisions, and mandatory construction requirements (Masonry Standards Joint Committee, 2005a and b and 2008a and b). These U.S. consensus standards are augmented by refereed documents (The Masonry Society, 2007) and the online recommendations of the Autoclaved Aerated Concrete Products Association (<http://www.aacpa.org/>).

In the United States, AAC masonry buildings built with local approvals, under design rules consistent with the consensus standards, and with heights greater than those permitted by these provisions, have successfully resisted hurricane winds with no damage.

The seismic design factors, SDC limits, and height restrictions of these provisions are consistent (or even more conservative) than those assigned to Ordinary Reinforced Masonry Shear Walls of clay or concrete masonry.

ADDITIONAL REFERENCES FOR CHAPTER 14 COMMENTARY

- Ali, A. and J. K. Wight. 1990. *Reinforced Concrete Structural Walls with Staggered Opening Configurations Under Reversed Cyclic Loading*, Report UMCE 90-05. Department of Civil Engineering, University of Michigan, Ann Arbor.
- American Concrete Institute Innovation Task Group I and Collaborators. 2001. *Acceptance Criteria for Moment Frames Based on Structural Testing*, T1.1-01, and *Commentary*, T1.1R-01. ACI, Farmington Hills, Michigan.
- American Concrete Institute Innovation Task Group I and Collaborators. 2001. "Special Hybrid Moment Frames Composed of Discretely Jointed Precast and Post-Tensioned Concrete Members (ACI T1.2-XX) and Commentary (ACI T1.2R-XX)," *ACI Structural Journal*, 98(5):771-784.
- American Society of Testing and Materials. 2007. "Standard Specification for Precast Autoclaved Aerated Concrete (PAAC) Wall Construction Units," ASTM C1386-07, *Annual Book of ASTM Standards*. American Society of Testing and Materials, West Conshohocken, Pennsylvania.
- Applied Technology Council. 2008. *Quantification of Building Seismic Performance Factors: 90 Percent Complete Draft*, FEMA P-695. Federal Emergency Management Agency, Washington, D.C.
- Banks, G., and J. Stanton. 2005. "Panel-to-Panel Connections for Hollow-Core Shear Walls Subjected to Seismic Loading," in *Proceedings of the 2005 PCI Convention*, Palm Springs, California.
- Bora, C., M. G. Oliva, S. D. Nakaki, and R. Becker. 2005. "Development of a Precast Concrete Shear-Wall System Requiring Special Code Acceptance," *PCI Journal*, 52(1):122-135.
- Building Seismic Safety Council. 1987. *Guide to Use of NEHRP Recommended Provisions in Earthquake Resistant Design of Buildings*, 1985 Edition, FEMA 140. FEMA, Washington, D.C.
- Building Seismic Safety Council. 2000. *NEHRP Recommended Provisions for Seismic Regulations for New Buildings and Other Structures*, FEMA 368 and 369. FEMA, Washington, D.C.
- Cheok, G. S., and H. S. Lew. 1991. "Performance of Precast Concrete Beam-to-Column Connections Subject to Cyclic Loading," *PCI Journal*, 36(3):56-67.
- Duffy, T. A., A. Goldman, and C. R. Farrar. 1993. *Shear Wall Ultimate Drift Limits*, Report NUREG/CR-6104, LA-12649-MS. U.S. Nuclear Regulatory Commission, Washington, D.C.
- Elliott, K. S., G. Davies, and W. Omar. 1992. "Experimental and Theoretical Investigation of Precast Concrete Hollow-Cored Slabs Used as Horizontal Floor Diaphragms," *The Structural Engineer*, 70(10):175-187.
- Englekirk, R. E. 1987. "Concepts for the Development of Earthquake Resistant Ductile Frames of Precast Concrete," *PCI Journal*, 32(1).
- Fahnestock, Larry A., James M. Ricles, and Richard Sause. 2006. "Experimental Study of a Large-Scale Buckling Restrained Using the Pseudo-Dynamic Testing Method" in *Proceedings of the 8th National Conference on Earthquake Engineering*, San Francisco, California.
- Fanous, A., S. Sritharan, M. Suleiman, and A. Arulmoli, A. 2007. *Minimum Spiral Reinforcement Requirements and lateral Displacement Limits for Prestressed Concrete Piles in High Seismic Regions*, ISU-ERI Ames Report. Department of Civil, Construction and Environmental Engineering, Iowa State University, Ames.

- Federal Emergency Management Agency. 2000. "Concrete," Chapter 6 in *NEHRP Guidelines for the Seismic Rehabilitation of Buildings*, FEMA 356 and 357. FEMA, Washington, D.C.
- French, C. W., M. Hafner, and V. Jayashanker. 1989. "Connections Between Precast Elements - Failure Within Connection Region," *ASCE Journal of Structural Engineering*, 115(12):3171-3192.
- Hawkins, N. M., and R. E. Englekirk. 1987. "U.S.-Japan Seminar on P/C Concrete Construction in Seismic Zones," *PCI Journal*, 32(2).
- Hidalgo, P.A., C.A. Ledezma, and R. A. Jordan. 2002. "Seismic Behavior of Squat Reinforced Concrete Shear Walls," *Earthquake Spectra*, 18(2):287-308.
- Hutchinson, R.L., S.H. Rizkalla, M. Lau, and M. Heuvel. 1991. "Horizontal Post-Tensioned Connections for Precast Concrete Bearing Shear Walls," *PCI Journal*, 36(3):64-76.
- International Code Council. 2006. *International Building Code*. ICC, Falls Church, Virginia.
- International Conference of Building Officials. 1997. *Uniform Building Code*, Vol. 2, Structural Engineering Design Provisions. ICBO, Whittier, California.
- Ishizuka, T., and N. M. Hawkins. 1987. *Effect of Bond Deterioration on the Seismic Response of Reinforced and Partially Prestressed Concrete and Ductile Moment Resistant Frames*, SM87-2. University of Washington, Department of Civil Engineering.
- Jayashanker, V., and C. E. French. 1988. *An Interior Moment Resistant Connection Between Precast Elements Subjected to Cyclic Lateral Loads*, Structural Engineering Report 87-10. University of Minnesota, Minneapolis.
- Kurama, Y. C. 2002. "Hybrid Post-Tensioned Precast Concrete Walls for Use in Seismic Regions," *PCI Journal*, 47(5):36-59.
- Masonry Standards Joint Committee (MSJC). 2005a. *MSJC Code and Specification: Building Code Requirements for Masonry Structures*, ACI 530-05/ASCE 5-05/TMS 402-05. The American Concrete Institute, Farmington Hills, Michigan; the American Society of Civil Engineers, Reston, Virginia; and the Masonry Society, Boulder, Colorado.
- Masonry Standards Joint Committee (MSJC). 2005a. *MSJC Code and Specification: Specifications for Masonry Structures*, ACI 530.1-05/ASCE 6-05/TMS 602-05. The American Concrete Institute, Farmington Hills, Michigan; the American Society of Civil Engineers, Reston, Virginia; and the Masonry Society, Boulder, Colorado.
- Masonry Standards Joint Committee (MSJC). 2008a. *MSJC Code and Specification: Building Code Requirements for Masonry Structures*, TMS 402-08/ACI 530-08/ASCE 5-08. The Masonry Society, Boulder, Colorado; the American Concrete Institute, Farmington Hills, Michigan; and the American Society of Civil Engineers, Reston, Virginia.
- Masonry Standards Joint Committee. 2008b. *MSJC Code and Specification: Specifications for Masonry Structures*, TMS 602-08/ACI 530.1-08/ASCE 6-08. The Masonry Society, Boulder, Colorado; the American Concrete Institute, Farmington Hills, Michigan; and the American Society of Civil Engineers, Reston, Virginia.
- Mast, R. F. 1992. "A Precast Concrete Frame System for Seismic Zone Four." *PCI Journal* 37(1):50-64.
- Precast/Prestressed Concrete Institute. 2004. "Precast Prestressed Concrete Piles," Chapter 20 in *Bridge Design Manual*, PCI BM-20-04. PCI, Chicago, Illinois.
- The Masonry Society. 2007. *Masonry Designers' Guide*, 5th ed., edited by Phillip J. Samblanet. The Masonry Society, Boulder, Colorado.
- Nakaki, S. D., and R. E. Englekirk. 1991. "PRESSSS Industry Seismic Workshops: Concept Development," *PCI Journal* 36(5):54-61.
- Nakaki, S., J. F. Stanton, and S. Sritharan. 2001. "The PRESSSS Five-Story Precast Concrete Test Building, University of California, San Diego, La Jolla, California," *PCI Journal*, 46(5):20-26.
- National Fire Protection Association. 2006. *Building Construction and Safety Code*, NFPA 5000. NFPA, Quincy, Massachusetts.
- Neille, D. S. 1977. "Behavior of Headed Stud Connections for Precast Concrete Connections for Precast Concrete Panels Under Monotonic and Cycled Shear Loading," thesis submitted in partial fulfillment of the requirements of Doctor of Philosophy, University of British Columbia.
- New Zealand Society for Earthquake Engineering. 1991. "Guidelines for the Use of Structural Precast Concrete in Buildings."
- Park, R., and K. J. Thompson. 1977. "Cyclic Load Tests on Prestressed and Partially Prestressed Beam-Column Joints," *PCI Journal*, 22(5):84-110.
- PCI Ad Hoc Committee on Precast Walls. 1997. "Design for Lateral Force Resistance with Precast Concrete Shear Walls," *PCI Journal*, 42(2):44-65.

- Pekau, O. A., and D. Hum. 1991. "Seismic Response of Friction-Jointed Precast Panel Shear Walls," *PCI Journal*, 36(2):56-71.
- Powell, G., F. Filippou, V. Prakash, and S. Campbell. 1993. "Analytical Platform for Precast Structural Systems," in *Proceedings, ASCE Structures Congress '93*. ASCE, New York.
- Priestley, M. J. N. 1991. "Overview of PRESSSS Research Program," *PCI Journal* 36(4):50-57.
- Priestley, M. J. N., and J. T. Tao. 1993. "Seismic Response of Precast Prestressed Concrete Frames with Partially Debonded Tendons," *PCI Journal*, 38(1):58-69.
- Priestley, M. J. N., S. Sriharan, J. Conley, and S. Pampanin. 1999. "Preliminary Results and Conclusions from the PRESSSS Five-Story Precast Concrete Test Building," *PCI Journal*, 44(6):42-67.
- Schultz, A. E. and R.A. Magana. 1996. "Seismic Behavior of Connections in Precast Concrete Walls," Paper SP 162-12, in *Proceedings of the Mete A. Sozen Symposium*, pp.273-311, ACI SP 162. American Concrete Institute, Farmington Hills, Michigan.
- Seo, S-Y., L-H Lee, and N. M. Hawkins. 1998. "The Limiting Drift and Energy Dissipation Ratio for Shear Walls Based on Structural Testing," *Journal of the Korean Concrete Institute*,10(6):335-343.
- Stanton, J. F., T. R. Hicks, and N. M. Hawkins. 1991. "PRESSSS Project 1.3: Connection Classification and Evaluation," *PCI Journal*, 36(5):62-71.
- Stanton, J. F. and S. D. Nakaki. 2002. *Design Guidelines for Precast Concrete Seismic Structural Systems-Unbonded Post-Tensioned Split Walls*, PRESSSS Report 01/03-09, UW Report SM 02-02. Department of Civil Engineering, University of Washington, Seattle.
- Tanner, J. E., J. L. Varela, and R. E. Klingner. 2005a. "Design and Seismic Testing of a Two-story Full-scale Autoclaved Aerated Concrete (AAC) Assemblage Specimen," *ACI Structures Journal*, 102 (1):114-119.
- Tanner, J. E., J. L. Varela, R. E. Klingner, M. J. Brightman, and U. Cancino.2005b. "Seismic Testing of Autoclaved Aerated Concrete (AAC) Shear Walls: A Comprehensive Review," *Structures Journal*, American Concrete Institute, Farmington Hills, Michigan, vol. 102, no. 3, May - June 2005, pp. 374-382.
- Taylor, C. P., P. E. Cote, and J. W. Wallace. "Design of Slender Reinforced Concrete Walls with Openings," *ACI Structural Journal*, 95(4):420-433.
- Thompson, K. J., and R. Park. 1980. "Seismic Response of Partially Prestressed Concrete," *ASCE Journal of the Structural Division*, 106(ST8):1755-1775.
- Uang, C-M., and A. Maarouf. 1993. "Seismic Displacement Amplification Factor in Uniform Building Code," SEAONC Research Bulletin Board, BB93-3, pp. B1-B2, and "Displacement Amplification Factor for Seismic Design Provisions," in *Proceedings of the Structures Congress*, ASCE, Vol.1, pp. 211-216. Irvine, California.
- Uriz, Patxi, and Stephen A. Mahin. 2004. "Seismic Performance Assessment of Concentrically Braced Steel Frames," Paper 1639 in *Proceedings of the 13th World Conference on Earthquake Engineering*. Vancouver, B.C., Canada.
- Varela et al. 2006: Varela, J. L., J. E. Tanner, and R. E. Klingner. 2006. "Development of Seismic Force-Reduction and Displacement Amplification Factors for AAC Structures," *Earthquake Spectra*, 22(1):267-286.

Modifications to Chapter 15, Seismic Design Requirements for Nonbuilding Structures

TABLE 15.4-2, SEISMIC COEFFICIENTS FOR NONBUILDING STRUCTURES NOT SIMILAR TO BUILDINGS

Revise the following items as indicated (deletions in strikeout and additions underlined):

Cast-in-place concrete silos, stacks, and chimneys having walls continuous to the foundation	15.6.2	3	1.75	3	NL	NL	NL	NL	NL
All other reinforced masonry structures not similar to buildings	14.4.1	3	2	2.5	NL	NL	NL	50	50
All other nonreinforced masonry structures not similar to buildings	14.4.1	1.25	2	1.5	NL	NL	50	50	50
<u>Concrete chimneys and stacks</u>	<u>15.6.2</u>	<u>2</u>	<u>1.5</u>	<u>1.5</u>	<u>NL</u>	<u>NL</u>	<u>NL</u>	<u>NL</u>	<u>NL</u>
All other steel and reinforced concrete distributed mass cantilever structures not covered herein including stacks, chimneys, silos, and skirt-supported vertical vessels that are not similar to buildings	15.6.2 15.7.10 and 15.7.10.5 a and b.	3	2	2.5	NL	NL	NL	NL	NL

SECTION 15.5.3, STEEL STORAGE RACKS

Replace with the following:

15.5.3 Steel Storage Racks. Steel storage racks supported at or below grade shall be designed in accordance with Section 2.7 of the ANSI/RMI MH 16.1 standard and its force and displacement requirements.

For storage racks supported above grade, the value of V in Section 2.7.2 of ANSI/RMI MH 16.1 shall not be taken less than the value of F_p determined in accordance with Section 13.3.1 of this standard, where R_p is taken equal to R , and a_p is taken equal to 2.5.

Alternatively, in addition to the requirements of Section 15.5.1, steel storage racks shall be designed in accordance with the requirements of Sections 15.5.3.1 through 15.5.3.4

[Sections 15.5.3.1 through 15.5.3.4 are unchanged.]

SECTION 15.6.2, STACKS AND CHIMNEYS

Replace with the following:

15.6.2 Stacks and Chimneys. Stacks and chimneys are permitted to be either lined or unlined and shall be constructed from concrete, steel, or masonry. Steel stacks, concrete stacks, steel chimneys, concrete chimneys, and liners shall be designed to resist seismic lateral forces determined from a substantiated analysis using reference documents. Interaction of the stack or chimney with the liners shall be considered. A minimum separation shall be provided between the liner and chimney equal to C_d times the calculated differential lateral drift.

For concrete chimneys assigned to Seismic Design Category D, E or F, splices for vertical rebar shall be staggered such that no more than 50 percent of the bars are spliced at any elevation. Design and detailing of cross-sections in the regions of breach openings, where the loss of cross-sectional area is greater than 10 percent, shall be performed in one of the following ways:

- a. For vertical force, shear force, and bending moment demands along the vertical direction, design the affected cross-section using the overstrength factor of 1.5. The following detailing requirements shall be satisfied:
 - i. The region of such overstrength shall extend above and below (except if the opening is at the base) the opening(s) by a distance equal to half of the width of the largest opening in the affected region.
 - ii. Appropriate reinforcement development lengths shall be provided beyond the required region of overstrength.

- iii. The jamb regions around each opening shall be detailed using the column tie requirements in Section 7.10.5 of ACI 318. Such detailing shall extend for a jamb width of a minimum of two times the wall thickness and for a height of the opening height plus twice the wall thickness above and below the opening, but no less than the development length of the longitudinal bars. The percentage of longitudinal reinforcement in jamb regions shall meet the requirements of Section 10.9 of ACI 318 for compression members.
- b. Provided that the cross-sectional moment of inertia in the opening region is at least 70 percent of the same above and below it, it shall be permitted to treat the breach opening region as follows:
 - i. All detailing requirements listed in Item a. above for the overstrength option shall be followed, in addition to the ones listed below.
 - ii. Hoop ties in jamb regions shall be detailed as columns of intermediate moment frames using the requirements in Section 21.3.5 of ACI 318. The dimensions for jamb region shall be the same as that required in Item a. above for the overstrength option.
 - iii. No construction joints within the opening region plus two times the wall thickness above and below the opening.
 - iv. Ratio of outer diameter to wall thickness shall not exceed 20 within the opening region.

SECTION 15.7.6, GROUND-SUPPORTED STORAGE TANKS FOR LIQUIDS

Add the following exception to the end of Section 15.7.6.1, General:

EXCEPTION: For $T_c > 4$ seconds, S_{ac} may be determined by a site-specific study using one or more of the following methods: (a) the procedures found in Chapter 21, provided such procedures, which rely on ground-motion attenuation equations for computing response spectra, cover the natural period band containing T_c , (b) ground-motion simulation methods employing seismological models of fault rupture and wave propagation, and (c) analysis of representative strong-motion accelerogram data with reliable long-period content extending to periods greater than T_c . However, in no case shall the value of S_{ac} be taken as less than the minimum of:

1. The value determined in accordance with Equation 15.7-11 using 50 percent of the mapped value of T_L from Figure 22-7 or
2. 0.8 times the value determined in accordance with Equation 15.7-11 using the mapped value of T_L from Figure 22-7.

In determining the value of S_{ac} , the value of T_L shall not be less than 4 seconds.

Commentary to Chapter 15 Modifications

COMMENTARY TO SECTION 15.5.3

C15.5.3 Steel Storage Racks. The two approaches to the design of steel storage racks set forth by the standard are intended to produce comparable results. The specific revisions to the RMI specification cited in earlier editions of the *Provisions* and the detailed requirements of the new ANSI/RMI standard reflect the recommendations of FEMA 460, *Seismic Considerations for Steel Storage Racks Located in Areas Accessible to the Public*.

COMMENTARY TO SECTION 15.6.2

C15.6.2 Stacks and Chimneys. The design of stacks and chimneys to resist natural hazards generally is governed by wind design considerations. The exceptions to this general rule involve locations with high seismicity, stacks and chimneys with large elevated masses, and stacks and chimneys with unusual geometries. It is prudent to evaluate the effect of seismic loads in all but those areas with the lowest seismicity. Although not specifically required, it is recommended that the special seismic details required elsewhere in the standard be considered for application to stacks and chimneys.

Concrete chimneys have low ductility, and their seismic behavior is especially critical in the opening regions due to inherent reduction in strength and loss of confinement for vertical reinforcement in the jamb regions around the openings. Spectacular earthquake-induced chimney failures have occurred in recent history (in Turkey in 1999) and have been attributed to strength/detailing problems (Kilic and Sozen, 2003). Therefore, the R value of 3 traditionally used in ASCE/SEI 7-05 for

concrete stacks and chimneys is reduced to 2 and detailing requirements for breach openings are added in the 2009 *NEHRP Recommended Seismic Provisions*.

Guyed steel stacks and chimneys are generally lightweight. As a result, the design loads due to natural hazards generally are governed by wind. On occasion, large flares or other elevated masses located near the top may require in-depth seismic analysis. Although it does not specifically address seismic loading, Chapter 6 of Troitsky (1982) provides a methodology appropriate for resolution of the seismic forces defined in the standard.

COMMENTARY TO SECTION 15.7.6.1

C15.7.6.1 General. The response of ground storage tanks to earthquakes is well documented by Housner, Mitchell and Wozniak, Veletsos, and others. Unlike building structures, the structural response of these tanks is influenced strongly by the fluid-structure interaction. Fluid-structure interaction forces are categorized as sloshing (convective) and rigid (impulsive) forces. The proportion of these forces depends on the geometry (height-to-diameter ratio) of the tank. API 650, API 620, AWWA D100, AWWA D110, AWWA D115, and ACI 350.3 provide the data necessary to determine the relative masses and moments for each of these contributions.

The standard requires that these structures be designed in accordance with the prevailing reference documents, except that the height of the sloshing wave, δ_s , must be calculated using Equations 15.7-13. Note that API 650 and AWWA D100 include this requirement in their latest editions.

Equations 15.7-10 and 15.7-11 provide the spectral acceleration of the sloshing liquid for the constant-velocity and constant-displacement regions of the response spectrum, respectively. The 1.5 factor in these equations is an adjustment for 0.5 percent damping. An exception in the use of Equation 15.7-11 was added for the 2009 *NEHRP Recommended Seismic Provisions*. Actual site-specific studies carried out since the introduction of the T_L requirements of ASCE/SEI 7-05 indicate that the mapped values of T_L are extremely conservative. Because a revision of the T_L maps is a time-consuming task that would not be possible during the 2009 *Provisions* update cycle, an exception was added to allow the use of site-specific values that are less than the mapped values with a floor of 4 seconds or one-half the mapped value of T_L . The exception was added under Section 15.7.6 because T_L is a tank issue. Discussion of the site-specific procedures can be found in the Part 2 Commentary for Chapter 22.

ADDITIONAL REFERENCE FOR CHAPTER 15 COMMENTARY

Kilic, S., and M. Sozen. 2003. "Evaluation of Effect of August 17, 1999, Marmara Earthquake on Two Tall Reinforced Concrete Chimneys," *ACI Structural Journal*, 100(3).

Page intentionally left blank.

Modification to Chapter 16, Seismic Response History Procedures

SECTION 16.1.3.2, THREE-DIMENSIONAL ANALYSIS

Replace with the following:

16.1.3.2 Three-Dimensional Analysis. Where three-dimensional analyses are performed, ground motions shall consist of pairs of appropriate horizontal ground motion acceleration components that shall be selected and scaled from individual recorded events. Appropriate ground motions shall be selected from events having magnitudes, fault distances, and source mechanisms that are consistent with those that control the risk-targeted maximum considered earthquake (MCE_R). Where the required number of recorded ground motion pairs is not available, appropriate simulated ground motion pairs are permitted to be used to make up the total number required. For each pair of horizontal ground motion components, a square root of the sum of squares (SRSS) spectrum shall be constructed by taking the SRSS of the 5-percent-damped response spectra for the scaled components (for direct scaling, an identical scale factor is applied to both components of a pair). Each pair of motions shall be scaled such that for each period between $0.2T$ and $1.5T$, the average of the SRSS spectra from all horizontal component pairs does not fall below the corresponding ordinate of the MCE_R response spectrum determined in accordance with Section 11.4.5 or 11.4.7.

At sites within 5 km of an active fault that controls the hazard, each pair of components shall be rotated to the fault-normal and fault-parallel direction of the causative fault and shall be scaled so that the average of the fault-normal components is not less than the MCE_R response spectrum for each period between $0.2T$ and $1.5T$.

Commentary to Chapter 16 Modification

COMMENTARY TO SECTION 16.1.3.2

C16.1.3.2 Three-dimensional Analyses. One key change to the ground motion design requirements developed by the BSSC’s Seismic Design Procedure Review Group (SDPRG) for the 2009 *NEHRP Recommended Seismic Provisions* is the use of maximum direction ground motions. In addition to changing the design values defined in Chapter 11 and used throughout the *Provisions*, implementing maximum direction ground motions affects the previous ground motion scaling rules specified in Section 16.1.3.2. Studies (Maffei and Hashemi, 2008) of 50 ground motions of M6.5-M7.9 earthquakes for both far-field and near-field records and for periods in the range of 0.1 to 3.0 seconds indicate that the maximum direction of ground motion is slightly less than the SRSS of the two components with the SRSS spectrum tending to be approximately 1.16 times the maximum direction spectrum.

For each of the 50 ground motions, the maximum response of a single-degree-of-freedom (SDOF) oscillator (assuming 5-percent damping) was determined for ground motion orientations from 0 to 90 degrees (in one-degree increments) and was compared to the associated SRSS of maximum response. The ratios of the SRSS of maximum response and the maximum amplitude of the response for varying parameters are given in Tables C16.1.3.2-1 through C16.1.3.2-3.

Table C16.1.3.2-1 Ratio of SRSS of Maximum Response to Maximum Amplitude as a Function of SDOF Period

SDoF Period	Number of Data Points	Ratio-Mean	Ratio -Standard Deviation
0.1 sec	50	1.19	0.077
0.3 sec	50	1.16	0.068
1.0 sec	50	1.14	0.067
3.0 sec	50	1.13	0.077
Average	200	1.16	0.076

Table C16.1.3.2-2 Ratio of SRSS of Maximum Response to Maximum Amplitude as a Function of Ground Motion Records

Ground Motion	Number of Data Points	Ratio-Mean	Ratio -Standard Deviation
Far-Field	88	1.16	0.067
Near-Field	112	1.15	0.078
Average	200	1.16	0.076

Table C16.1.3.2-3 Ratio of SRSS of Maximum Response to Maximum Amplitude as a Function of Site Class

Site Class	Number of Data Points	Ratio-Mean	Ratio -Standard Deviation
B	8	1.15	0.066
C	84	1.15	0.072
D	108	1.16	0.073
Average	200	1.16	0.076

The modified scaling requirements simplify phrasing of existing language by replacing 10 percent less than 1.16 times the MCE_R response spectrum with the MCE_R response spectrum, itself, resulting in an effective “1.0” multiplier. This effective multiplier comes from $(0.9)(1.16) \approx 1.0$.

However, for sites within approximately 5 km of an active fault that controls the ground-motion hazard, the near field strong-motion database indicates that the fault-normal (FN) direction is (or is close to) the direction of maximum ground motion for periods around 1.0 second and greater (Huang et al., 2008; Watson-Lamprey and Boore, 2007). In this case, the two horizontal components of a selected record are to be transformed so that one component is the motion in the FN direction and the other component is the motion in the fault-parallel (FP) direction. Scaling so that the average FN component response spectrum is at the level of the MCE_R response spectrum ensures that the FN components will not be underestimated, which would happen if the SRSS rule was applied at short distances. The same scale factor selected for the FN component of a given record is used for the FP component also.

ADDITIONAL REFERENCES FOR CHAPTER 16 COMMENTARY

Huang, Y. N., A. Whittaker, and N. Luco. 2007. “NGA Relationships, USGS Seismic Hazard Maps, Near-Fault Ground Motions and Site Effects: BSSC Project 07 Final Draft Report. BSSC, Washington, D.C.

Maffei, J., and A. Hashemi. 2008. Personal Communication.

Watson-Lamprey, J. A., and D. M. Boore. 2007. “Beyond $S_{a_{GMRot}}$: Conversion to $S_{a_{Arb}}$, $S_{a_{SN}}$, and $S_{a_{MaxRot}}$,” *Bulletin of the Seismology Society of America*, 97:1511-1524.

Modifications to Chapter 18, Seismic Design Requirements for Structures with Damping Systems

SECTION 18.3.1, NONLINEAR RESPONSE HISTORY PROCEDURE

Replace with the following:

18.3.1 Nonlinear Response History Procedure. A nonlinear response history (time history) analysis shall utilize a mathematical model of the structure and the damping system as provided in Chapter 16 and this section. The model shall directly account for the nonlinear hysteretic behavior of elements of the structure and the damping devices to determine its response, through methods of numerical integration, to suites of ground motions compatible with the design response spectrum for the site.

The analysis shall be performed in accordance with Chapter 16 together with the requirements of this section. Inherent damping of the structure shall not be taken greater than 5 percent of critical unless test data consistent with levels of deformation at or just below the effective yield displacement of the seismic-force-resisting system support higher values.

If the calculated force in an element of the seismic force-resisting system does not exceed 1.5 times its nominal strength, that element is permitted to be modeled as linear.

18.3.1.1 Damping Device Modeling. Mathematical models of displacement-dependent damping devices shall include the hysteretic behavior of the devices consistent with test data and accounting for all significant changes in strength, stiffness, and hysteretic loop shape. Mathematical models of velocity-dependent damping devices shall include the velocity coefficient consistent with test data. If this coefficient changes with time and/or temperature, such behavior shall be modeled explicitly. The elements of damping devices connecting damper units to the structure shall be included in the model.

Exception: If the properties of the damping devices are expected to change during the duration of the response history analysis, the dynamic response is permitted to be enveloped by the upper and lower limits of device properties. All these limit cases for variable device properties must satisfy the same conditions as if the time dependent behavior of the devices were explicitly modeled.

18.3.1.2 Response Parameters. For each ground motion analyzed, individual response parameters consisting of the maximum value of the individual member forces, member inelastic deformations and story drifts at each story shall be determined. Moreover, for each ground motion used for response history analysis, individual response parameters consisting of the maximum value of the discrete damping device forces, displacements, and velocities, in the case of velocity-dependent devices, shall be determined.

If at least seven ground motions are used for response history analysis, the design values of the damping device forces, displacements, and velocities are permitted to be taken as the average of the values determined by the analyses. If fewer than seven ground motions are used for response history analysis, the design damping device forces, displacements and velocities shall be taken as the maximum value determined by the analyses. A minimum of three ground motions shall be used.

SECTION 18.3.2, NONLINEAR STATIC PROCEDURE

Replace with the following:

18.3.2 Nonlinear Static Procedure. Nonlinear static procedures may be used to construct the lateral force-displacement curve of the seismic-force-resisting system in lieu of the elastoplastic curve assumed in the response spectrum procedure and in the equivalent lateral force procedure. When nonlinear static procedures is used, the nonlinear modeling described Chapter 16 shall be used. The resulting force-displacement curve shall be used in lieu of the assumed effective yield displacement, D_Y , of Equation 18.6-10 to calculate the effective ductility demand under the design earthquake ground motion, μ_D , and under the risk-targeted maximum considered earthquake ground motion, μ_M , in Equations 18.6-8 and 18.6-9, respectively. The value of (R/C_d) shall be taken as 1.0 in Equations 18.4-4, 18.4-5, 18.4-8, and 18.4-9 for the response spectrum procedure, and in Equations 18.5-6, 18.5-7 and 18.5-15 for the equivalent lateral force procedure.

Page intentionally left blank.

Chapter 19, Soil Structure Interaction for Seismic Design

TABLE 19.2-1, VALUES OF G / G_0 AND V_s / V_{s0}

Replace with the following:

Site Class	Value of v_s / v_{s0}			Value of G / G_0		
	$S_{DS}/2.5$					
	≤ 0.1	0.4	≥ 0.8	≤ 0.1	0.4	≥ 0.8
A	1.00	1.00	1.00	1.00	1.00	1.00
B	1.00	0.97	0.95	1.00	0.95	0.90
C	0.97	0.87	0.77	0.95	0.75	0.60
D	0.95	0.71	0.32	0.90	0.50	0.10
E	0.77	0.22	*	0.60	0.05	*
F	*	*	*	*	*	*

Note: Use straight line interpolation for intermediate values of $S_{DS}/2.5$.

* Should be evaluated from site-specific analysis.

FIGURE 19.2-1, FOUNDATION DAMPING FACTOR

Replace with the following:

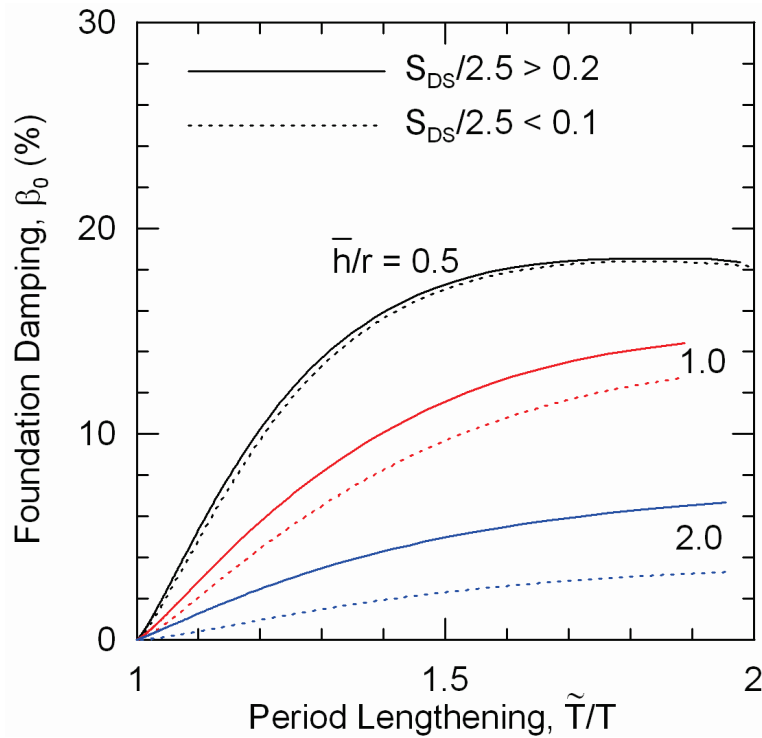

Page intentionally left blank.

Modification to Chapter 21, Site-Specific Ground Motion Procedures for Seismic Design

SECTION 21.2, GROUND MOTION HAZARD ANALYSIS

Replace Sections 21.2.1 through 21.2.3 with the following:

21.2.1 Probabilistic Ground Motions. The probabilistic spectral response acceleration shall be taken as the spectral response acceleration in the maximum direction of ground motions represented by a 5 percent damped acceleration response spectrum that is expected to achieve a 1 percent probability of collapse within a 50-year period. For the purpose of this provision, ordinates of the probabilistic ground-motion response spectrum shall be determined by either Method 1 of Section 21.2.1.1 or Method 2 of Section 21.2.1.2.

21.2.1.1 Method 1. Ordinates of the probabilistic ground-motion response spectrum shall be determined as the product of the risk coefficient at each spectral response period, C_R , and the spectral response acceleration represented by a 5 percent damped acceleration response spectrum having a 2 percent probability of exceedance within a 50-year period. The value of the risk coefficient, C_R , shall be determined using values of C_{RS} and C_{RI} from Figures 22-3 and 22-4, respectively. At spectral response periods less than or equal to 0.2 second, C_R shall be taken as equal to C_{RS} . At spectral response periods greater than or equal to 1.0 second, C_R shall be taken as equal to C_{RI} . At response spectral periods greater than 0.2 second and less than 1.0 second, C_R shall be based on linear interpolation of C_{RS} and C_{RI} .

21.2.1.2 Method 2. Ordinates of the probabilistic ground-motion response spectrum shall be determined at each spectral response period from the iterative integration of a site-specific hazard curve with a lognormal probability density function representing the collapse fragility (i.e., probability of collapse as a function of spectral response acceleration). At each period, the ordinate of the probabilistic ground-motion response spectrum shall achieve a 1 percent probability of collapse within a 50-year period for a collapse fragility having (i) a 10 percent probability of collapse at said ordinate of the probabilistic ground-motion response spectrum and (ii) a logarithmic standard deviation value of 0.8.

21.2.2 Deterministic Ground Motions. The deterministic spectral response acceleration at each period shall be calculated as the largest 84th percentile 5 percent damped spectral response acceleration in the direction of maximum horizontal response computed at that period for characteristic earthquakes on all known active faults within the region. For the purposes of this standard, the ordinates of the deterministic ground motions response spectrum shall not be taken as lower than the corresponding ordinates of the response spectrum determined in accordance with Figure 21.2-1, where F_a and F_v are determined using Tables 11.4-1 and 11.4-2, respectively, with the value of S_s taken as 1.5 and the value of S_l taken as 0.6.

21.2.3 Site-Specific MCE_R . The site-specific MCE_R spectral response acceleration at any period, S_{aM} , shall be taken as the lesser of the spectral response accelerations from the probabilistic ground motions of Section 21.2.1 and the deterministic ground motions of Section 21.2.2.

Commentary to the Chapter 21 Modification

C21.2 GROUND MOTION HAZARD ANALYSIS

As explained in the commentary to Chapter 11, the risk-targeted maximum considered earthquake ground motions (MCE_R) in the 2009 *NEHRP Recommended Seismic Provisions* are based on the 2008 USGS seismic hazard maps and also incorporate three technical changes to ASCE/SEI 7-05:

1. Use of risk-targeted ground motions,
2. Use of maximum direction ground motions, and
3. Use of near-source 84th percentile ground motions.

Reasons for use of maximum direction ground motions are explained first in the commentary below, because they apply to both the probabilistic and deterministic ground motions discussed subsequently. Use of risk-targeted and near-source 84th percentile ground motions are discussed in the probabilistic and deterministic ground motions sections below, respectively.

The requirements in the previous editions of the *Provisions* and ASCE/SEI 7 do not define the direction of ground motions used for design. The procedure used to develop the statistical estimate of ground motion results in the geometric mean (geomean) of two orthogonal components of motion at a site. Many engineers find the maximum direction to be a more meaningful parameter for structural design. The basic concept is that a structure is designed to resist the ground motion at its site; the prediction of ground motion is inherently statistical, and the basis for the statistical estimate of the ground motion is rooted in the probability that a structure will actually fail. In general, structures will not have the same resistance in all directions; however, for those structures in which seismic resistance is a significant economic factor, there is a tendency to design to the level required by building codes, with the result that the resistance of the structure is relatively insensitive to the direction of the motion. When one considers such structures subjected to two simultaneous components of ground motion, these structures characteristically fail in the direction of the stronger of the two components. Failure rates of simple buildings in one recent study (low-rise wood buildings in Applied Technology Council, 2008) show this effect: the overall failure rate for three-dimensional analyses was higher than those for two-dimensional analyses for the same set of structures analyzed for the same 22 pairs of ground motions. The specification of maximum direction ground motions reduces the probability of structural failure based upon equivalent static two-dimensional design compared to the use of the geomean based demand, but this reduction has not been quantified at this time. For consistency, revisions have been made to both probabilistic and deterministic ground motion criteria to reflect required use of maximum direction ground motions.

The USGS updates of the uniform-hazard and deterministic ground motion spectral value maps have used the new next generation attenuation (NGA) relations for sites in the western United States (WUS). The new NGA relationships output an average horizontal spectral demand and the dispersion in that demand, where this average is the rotated geomean denoted as GMRotI50 (Boore et al., 2006). GM denotes the geometric mean of two horizontal components, Rot denotes that rotations over all non-redundant angles are considered, I denotes that period-independent rotations are used, and 50 identifies the prediction of median values. The geometric mean of two horizontal components of ground motions is calculated as the square root of the product of the two horizontal response spectral accelerations at each period of interest. As demonstrated by Boore et al. (2006), GMRotI50 is numerically very similar to (i.e., within 3 percent of) the geometric mean of two as-recorded components that was typically the output of older attenuation relationships.

A recent study (Huang et al., 2008a) found that near-source ground motion spectral response accelerations of the new NGA relations are somewhat less than those in the maximum direction of response. This study (2008a, 2008b) focused on large magnitude earthquakes, with moment magnitudes greater than 6.5 and site-to-source distances less than 15 km. For this family of earthquake records, ground motions in the maximum direction of response are about 110 percent of 5 percent damped, short-period spectral response acceleration, and about 130 percent of 5 percent damped, 1-second spectral response acceleration calculated using the new NGA relations (GMRotI50). Table C21.2-1 presents summary results to enable calculation of median and 84th percentile ratios of maximum to geomean spectral demands across the period range of 0 to 4.0 seconds; values of the ratio are assumed to remain constant for periods greater than 4.0 seconds. Values are rounded to the nearest 0.1, which is the appropriate degree of precision. The ratio of 84th percentile (Column 3) to median (Column 2) demands is approximately 1.8 to 1.9. Linear interpolation should be used to establish values of the ratios for periods not listed.

Other regions (e.g., the central and eastern United States) are expected to have similar ratios of maximum direction ground motions to geomean ground motions although the limited number of strong-motion records from the central and eastern United States precludes rigorous evaluation such as that performed by the NGA study (Huang et al., 2008). However, studies by Beyer and Bommer (2006) using a set of 949 earthquake records with much wider ranges of moment magnitude (4.2 to 7.9) and hypocentral distance (5 to 200 km) indicated similar ratios of maximum to geomean response to those of the Huang et al. study on large magnitude, near-fault ground motions. The Beyer and Bommer data set included records from 20+ European earthquakes.

Table C21.2-1 Median and 84th Percentile of the Ratio of Maximum Spectral Demand to Geomean Demand

Period (second)	Median	84th Percentile	Period (second)	Median	84th Percentile
0.0	1.1	2.0	0.5	1.2	2.1
0.1	1.1	2.0	1.0	1.3	2.3
0.2	1.1	2.0	2.0	1.3	2.5
0.3	1.1	2.0	4.0+	1.4	2.7

For consistency of ground motion scaling (against either geomean or maximum direction spectra) in three-dimensional response history analysis of structures, the 2009 *Provisions* has adopted changes related to Section 16.1.3.2 of ASCE/SEI 7-05 such that it enables the scaling of pairs of horizontal ground motion records matching maximum direction spectra (MCE_R or design spectra of maximum direction of response) to be equivalent to that matching the corresponding geomean spectra. Additional explanation of these changes is provided in Section C16.1.3.2.

C21.2.1 Probabilistic Ground Motions. The definition and basis of probabilistic ground motions in these new *Provisions* has changed from that in ASCE/SEI 7-05, from a 2 percent in 50-year hazard level to a 1 percent in 50-year collapse risk target. This change is intended to improve seismic design by achieving a more uniform level of collapse prevention. The change affects the calculation and values of probabilistic ground motions, but not their use in the design process (i.e., 5 percent damped spectral response accelerations are still used). The technical basis of the change can be found in “Risk-Targeted versus Current Seismic Design Maps for the Conterminous United States” (Luco et al., 2007). A summary of the technical basis is provided below.

In the 1997, 2000 and 2003 editions of the *NEHRP Recommended Provisions*, the probabilistic MCE ground motions are defined as those that have a 2 percent probability of being exceeded in 50 years. In other words, the probabilistic MCE ground motions are of uniform hazard, both geographically and across structural vibration periods. It has long been recognized, however, that “it really is the probability of structural failure with resultant casualties that is of concern, and the geographical distribution of that probability is not necessarily the same as the distribution of the probability of exceeding some ground motion” (p. 296 of ATC 3-06, 1978).

The primary reason that the two probabilities are not the same is that there are geographic differences in the shape of the ground motion versus annual frequency of exceedance hazard curves from which uniform-hazard ground motions are read. The commentary of earlier editions of the *Provisions* (post-1997) reports that “because of these differences, questions were raised concerning whether definition of the ground motion based on a constant probability for the entire United States would result in similar levels of seismic safety for all structures” (p. 319 of the 2003 *NEHRP Recommended Provisions Commentary*). The change to risk-targeted ground motions uses the different shapes of hazard curves to adjust the uniform-hazard (2-percent-in-50-years) ground motions such that they are expected to result in a uniform annual frequency of collapse, or risk level, when used in design. The adjustment factors, or risk coefficients, are akin to the ASCE/SEI 43-05 site-specific design factor, which is a function of an approximate slope of the ground motion hazard curve.

The adjustments to the uniform-hazard ground motions are computed by making use of the so-called risk integral (e.g., McGuire, 2004). The risk integral calculates an annual frequency of collapse by coupling the ground motion hazard curve at a location with the expected performance of a structure designed for that location. More precisely, the hazard curves are coupled with the conditional probability of collapse as a function of the ground motion level. Earlier editions of the *Provisions* express the expectation that “if a structure experiences a level of ground motion 1.5 times the design level [i.e., the MCE ground motion], the structure should have a low likelihood of collapse” (p. 320 of the 2003 *NEHRP Provisions Commentary*). This “low likelihood of collapse” has been estimated as 10 percent (Applied Technology Council, 2009) using state-of-the-art incremental dynamic analysis (e.g., Vamvatsikos and Cornell, 2002) of structures designed in accordance with this edition of the *NEHRP Recommended Seismic Provisions* (2009). For the likelihood of collapse under other (than the MCE) ground motion levels, a so-called β -value of 0.8 has been used for the 2009 *Provisions*, based on both the findings of the Applied Technology Council (2009) and other past research. Other β -values ranging from 0.5 to 1.0 have been considered, with little effect on the resulting risk coefficients. The ground motion hazard curves used in the risk integral are from the USGS.

Using more subjective estimates of the conditional probability of collapse as a function of the ground motion level, and early (1976) hazard curves for only four locations, the authors of the resource document on which the *Provisions* are based (Applied Technology Council, 1978) used the risk integral to estimate the annual frequency of collapse of buildings designed for uniform-hazard ground motions (see ATC 3-06, p. 310-311). They found that “the probabilities of failure [i.e., risk levels] were roughly the same for each of the four buildings.” In contrast, using contemporary hazard curves and building performance expectations, Luco et al. (2007) have found that the risk levels are systematically lower in the central and eastern United States (CEUS) than in the WUS due to well-documented differences in the shapes of ground motion hazard curves (e.g., Leyendecker et al., 2000). To result in uniform risk levels, adjustments to the uniform-hazard ground motions are needed.

The risk level targeted in these *Provisions* (2009) corresponds (approximately) to 1 percent probability of collapse in 50 years. This target is based on the average of the annual frequencies of collapse across the WUS that are expected to result from (as calculated via the risk integral) design for the probabilistic MCE ground motions in the 2003 *NEHRP Recommended Provisions*. Consequently, the requisite risk coefficients are generally within 15 percent of unity in the WUS (except in the coastal region of Oregon, where they are slightly smaller). In the CEUS, the risk coefficients are generally smaller, again due

to the well-documented differences in shapes of ground motion hazard curves there relative to the WUS. In the New Madrid seismic zone and near Charleston, South Carolina, in particular, the adjustments to the uniform-hazard ground motions are as small as a factor of 0.7. Compared to the underlying uniform-hazard ground motions, the risk coefficients are generally less sensitive to refinements of the ground motion hazard curves (e.g., USGS updates or site-specific analyses), since they depend on the shape but not amplitude of the hazard curves. They vary with the structural vibration period and site class, but not dramatically.

The change to risk-targeted probabilistic ground motions complements improvements to the basis for response modification factors (*R* factors) reflected in FEMA P-695 (Applied Technology Council, 2009) and provides a more rational basis for seismic design methods. As alluded to above, similar risk-based procedures are already being used for design and evaluation of nuclear facilities, as well as offshore structures.

C21.2.2 Deterministic Ground Motions. Deterministic ground motions should account for uncertainties associated with near-fault ground motions, particularly at longer periods, and necessitate a more statistically appropriate estimate of 5 percent damped spectral response accelerations than those based on the 150 percent of the median ground motions used in ASCE/SEI 7-05. The use of 84th percentile ground motions in these *Provisions* (2009) effectively requires increasing median ground motions by 180 percent. The technical basis of this change can be found in Huang et al. (2008a and 2008b). The authors found that 150 percent of the median spectral response accelerations of the new NGA relations (average of the three relations) to be significantly less than 84th percentile ground motions in the maximum direction of response. Near active sources (in the WUS), 84th percentile ground motion in the maximum direction of response is about 200 percent (1.8 x 110 percent) of 5 percent damped, short-period spectral response acceleration, and about 230 percent (1.8 x 130 percent) of 5 percent damped, 1-second spectral response acceleration of the new NGA relations for GMRotI50 (average value of the three NGA relations). Table C21.2-2 summarizes ratios of 84th percentile maximum direction to median geomean-direction response for periods from 0 to 4.0 seconds. Ratios for periods greater than 4.0 seconds are assumed to be the same as the ratio for 4.0 seconds.

Table C21.2-2 Ratios of 84th Percentile to Median Spectral Demands for NGA Relationships

		Period (seconds)					
		0.2	0.5	1.0	2.0	3.0	4.0
β	B-A	0.60	0.61	0.65	0.70	0.70	0.70
	C-B	0.59	0.59	0.62	0.64	0.65	0.65
	C-Y	0.61	0.63	0.63	0.67	0.67	0.70
y_{84} / y_{50}		1.82	1.84	1.89	1.95	1.96	1.98

ADDITIONAL REFERENCES FOR CHAPTER 21 COMMENTARY

Abrahamson, N., and W. J. Silva. 1997. "Empirical Response Spectral Attenuation Relations for Shallow Crustal Earthquakes." *Seismological Research Letters*, 68(1):94-127.

American Society of Civil Engineers. 2006. *Minimum Design Loads for Buildings and Other Structures*, ASCE/SEI 7-05. ASCE, Reston, Virginia.

American Society of Civil Engineers. 2005. *Seismic Design Criteria for Structures, Systems, and Components in Nuclear Facilities*, ASCE 43-05. ASCE, Reston, Virginia.

Applied Technology Council. 1978. *Tentative Provisions for the Development of Seismic Regulations for Buildings*, ATC 3-06. ATC, Palo Alto, California.

Applied Technology Council. 2009. *Quantification of Building Seismic Performance Factors*, FEMA P-695. Federal Emergency Management Agency, Washington, D.C.

Beyer, K., and J. J. Bommer. 2006. Relationships between Median Values and between Aleatory Variabilities for Different Definitions of the Horizontal Component of Motion, *Bulletin of the Seismological Society of America*, 96(4A):1512-1522.

Boore, D. M., and T. E. Fumal. 1997. "Equations for Estimating Horizontal Response Spectra and Peak Acceleration from Western North American Earthquakes: A Summary of Recent Work," *Seismological Research Letters*, 68(1):128-153.

-
- Boore, D. M., J. Watson-Lamprey, and N. A. Abrahamson. 2006. "Orientation-Independent Measures of Ground Motion," *Bulletin of the Seismological Society of America*, 96(4A):1502-1511.
- Boore, D. M., and G. M. Atkinson. 2007. *Boore-Atkinson NGA Ground Motion Relations for the Geometric Mean Horizontal Component of Peak And Spectral Ground Motion Parameters*, PEER 2007/01. Pacific Earthquake Engineering Research Center, Berkeley, California.
- Campbell, K. W., and Y. Bozorgnia. 2003. "Updated Near-Source Ground Motion (Attenuation) Relations for the Horizontal and Vertical Components of Peak Ground Acceleration and Acceleration Response Spectra." *Bulletin of the Seismological Society of America*, 93:314-331.
- Campbell, K. W., and Y. Bozorgnia. 2007. *Campbell-Bozorgnia NGA Ground Motion Relations for the Geometric Mean Horizontal Component of Peak and Spectral Ground Motion Parameters*, PEER 2007/02. Pacific Earthquake Engineering Research Center, Berkeley, California.
- Chiou, B. S.-J., and R. R. Youngs. 2006. *Chiou and Youngs PEER-NGA Empirical Ground Motion Model for the Average Horizontal Component of Peak Acceleration and Pseudo-Spectral Acceleration for Spectral Periods of 0.01 to 10 Seconds*. Pacific Earthquake Engineering Research Center, Berkeley, California, http://peer.berkeley.edu/products/CY-Program/Chiou_Youngs_NGA_2006.pdf.
- Huang, Y.-N, A. S. Whittaker, and N. Luco. 2008a. *NGA Relationships, USGS Seismic Hazard Maps, Near-Fault Ground Motions and Site Effects*, USGS, Golden, Colorado.
- Huang, Y.-N, A. S. Whittaker, and N. Luco. 2008b. "Maximum Spectral Demands in the Near-Fault Region," *Earthquake Spectra*, 24(1):319-341.
- Leyendecker, E.V., R. J. Hunt, A. D. Frankel, and K. S. Rukstales. 2000. "Development of Maximum Considered Earthquake Ground Motion Maps," *Earthquake Spectra*, 16(1):21-40.
- Luco, N., B. R. Ellingwood, R. O. Hamburger, J. D. Hooper, J. K. Kimball, and C. A. Kircher. 2007. "Risk-Targeted versus Current Seismic Design Maps for the Conterminous United States," in *Proceedings of the SEAOC 76th Annual Convention*. Structural Engineers Association of California, Sacramento, California.
- McGuire, R. K. 2004. *Seismic Hazard and Risk Analysis*, EERI Monograph MNO-10. Earthquake Engineering Research Institute, Oakland, California.
- Sadigh, K., C. Y. Chang, J. A. Egan, F. Makdisi, and R. R. Youngs. 1997. "Attenuation Relationships for Shallow Crustal Earthquakes Based on California Strong Motion Data." *Seismological Research Letters*, 68(1):180-189.
- Somerville, P. G., N. F. Smith, R. W. Graves, and N. A. Abrahamson. 1997. "Modification of Empirical Strong Ground Motion Attenuation Relations To Include the Amplitude And Duration Effects of Rupture Directivity," *Seismological Research Letters*, 68(1):199-222.
- Vamvatsikos, D., and C. A. Cornell. 2002. "Incremental Dynamic Analysis," in *Earthquake Engineering and Structural Dynamics*, 31(3):491-514.

Page intentionally left blank.

Modification to Chapter 22, Seismic Ground Motion and Long-period Transition Maps

Replace existing Chapter 22 with the following:

Chapter 22 SEISMIC GROUND MOTION, LONG-PERIOD TRANSITION, RISK COEFFICIENT, AND MCE GEOMEAN PGA MAPS

Contained in this chapter are Figures 22-1 through 22-7, which provide the mapped uniform-hazard ground motion parameters (S_{SUH} and S_{IUH}), the mapped risk coefficients (C_{RS} and C_{RI}), the mapped deterministic ground motion parameters (S_{SD} and S_{ID}), and the mapped long-period transition period (T_L), for use in applying the seismic provisions of ASCE/SEI 7. Also contained in this chapter are Figures 22-8 through 22-11, which provide the mapped maximum considered earthquake geometric mean peak ground accelerations.

These maps were prepared by the United States Geological Survey (USGS) and have been updated for the 2009 edition of the *NEHRP Recommended Seismic Provisions for New Buildings and Other Structures*. Maps for Guam and Tutuila (American Samoa) are not included because uniform-hazard ground motion parameters, deterministic ground motion parameters, and risk coefficients have not yet been developed for those islands. Therefore, like in the 2005 edition of ASCE/SEI 7, the parameters S_S and S_I defined in Section 11.4.3 shall be, respectively, 1.5 and 0.6 for Guam and 1.0 and 0.4 for Tutuila. The mapped maximum considered earthquake geometric mean peak ground accelerations shall be 0.6 for Guam and 0.4 for Tutuila.

The following is a list of figures contained in this chapter:

Figure 22-1 Uniform-hazard (2% in 50-year) ground motions of 0.2-second spectral response acceleration (5% of critical damping), Site Class B.

Figure 22-2 Uniform-hazard (2% in 50-year) ground motions of 1-second spectral response acceleration (5% of critical damping), Site Class B.

Figure 22-3 Risk coefficient at 0.2-second spectral response period.

Figure 22-4 Risk coefficient at 1-second spectral response period.

Figure 22-5 Deterministic ground motions of 0.2-second spectral response acceleration (5% of critical damping), Site Class B.

Figure 22-6 Deterministic ground motions of 1-second spectral response acceleration (5% of critical damping), Site Class B.

Figure 22-7 Long-period transition period, T_L (seconds).

Figure 22-8 MCE geometric mean PGA, %g, Site Class B for the coterminous United States.

Figure 22-9 MCE geometric mean PGA, %g, Site Class B for Alaska.

Figure 22-10 MCE geometric mean PGA, %g, Site Class B for Hawaii.

Figure 22-11 MCE geometric mean PGA, %g, Site Class B for Puerto Rico and the United States Virgin Islands.

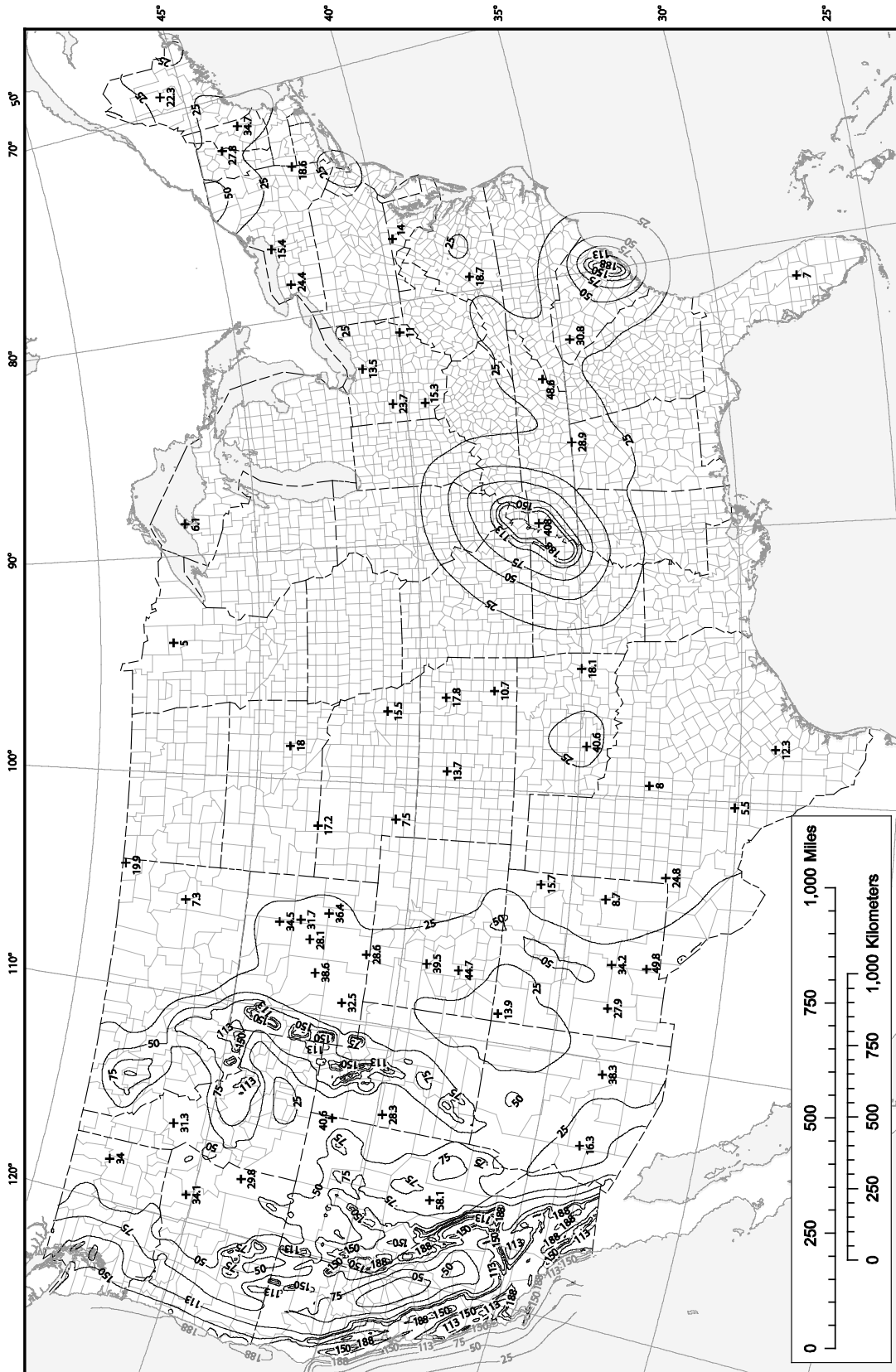
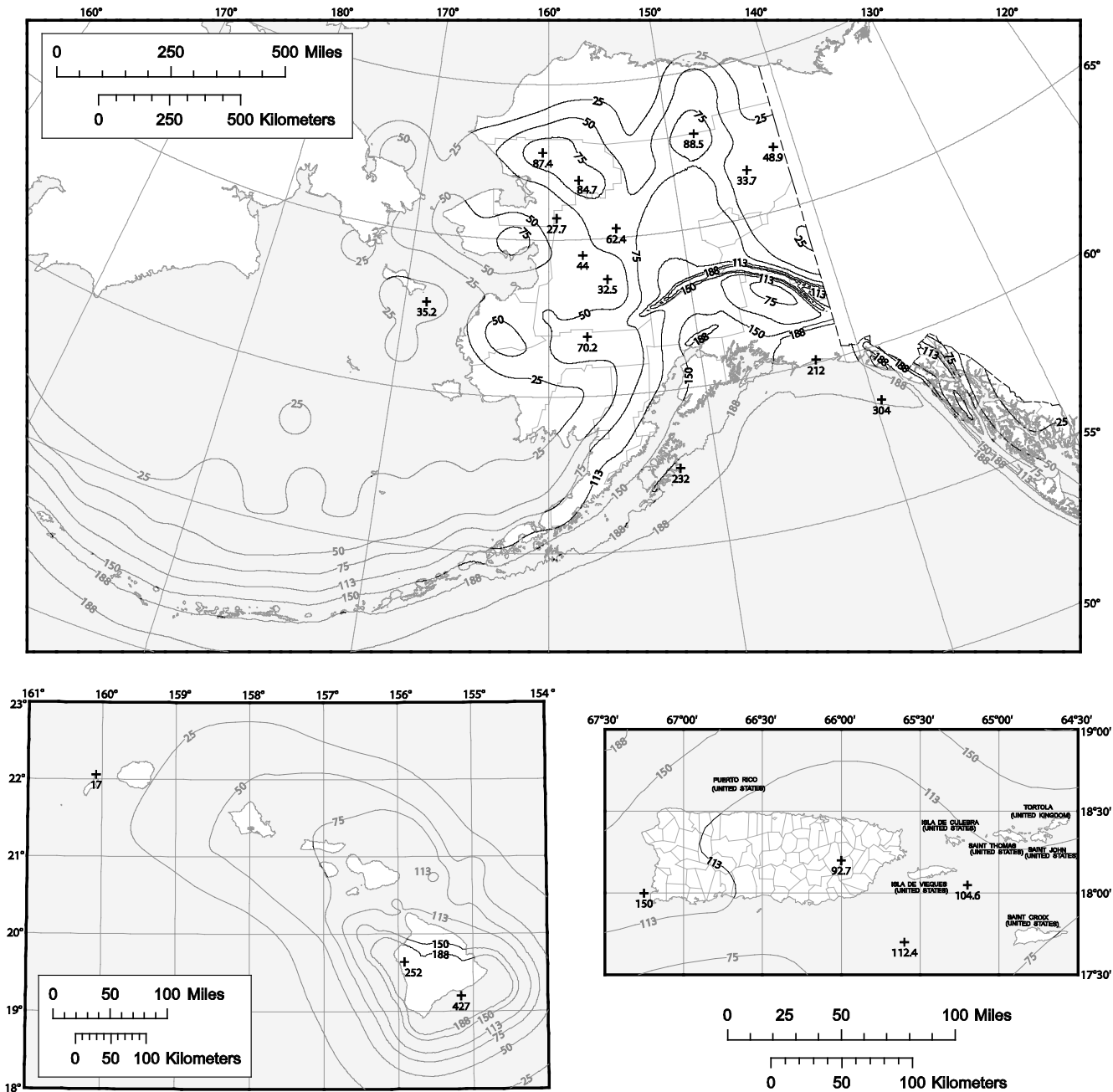

Figure 22-1 Uniform-hazard (2% in 50-Year) ground motions of 0.2-second spectral response Acceleration (5% of critical damping), Site Class B



Contours and spot values are in units of %g

Notes:

- Maps prepared by United States Geological Survey (USGS).
- Ground motion values contoured on these maps are for the maximum direction of acceleration. As such, they are different (by a factor of 1.1) from those on the 2008 USGS National Seismic Hazard Maps posted at <http://earthquake.usgs.gov/research/hazmaps/>.
- Larger, more detailed versions of these maps are not included because it is recommended that the corresponding USGS web tool (<http://earthquake.usgs.gov/designmaps/>) be used to determine the mapped value for a specified location.

Figure 22-1 (continued) Uniform-hazard (2% in 50-Year) ground motions of 0.2-second spectral response Acceleration (5% of critical damping), Site Class B

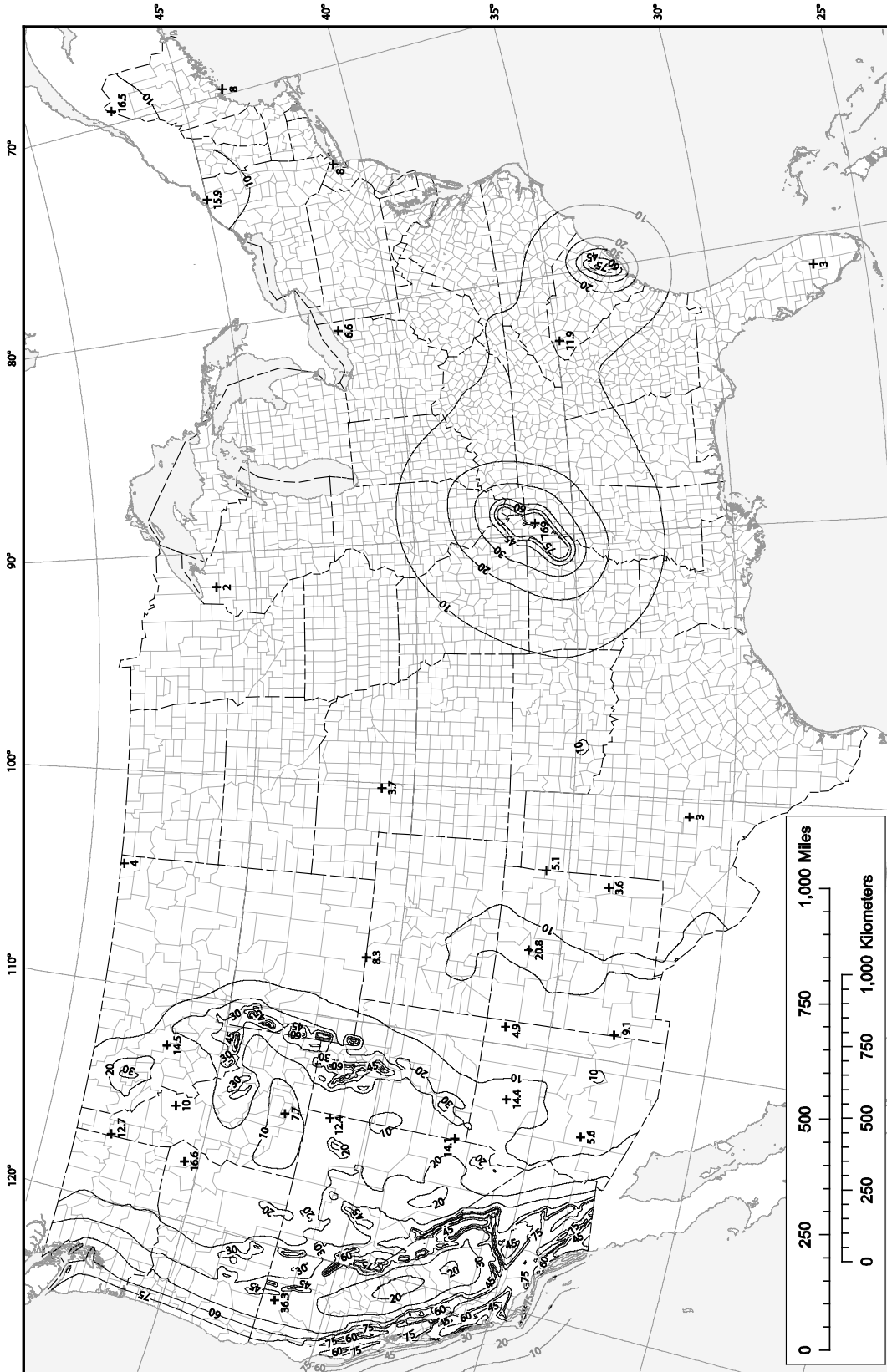
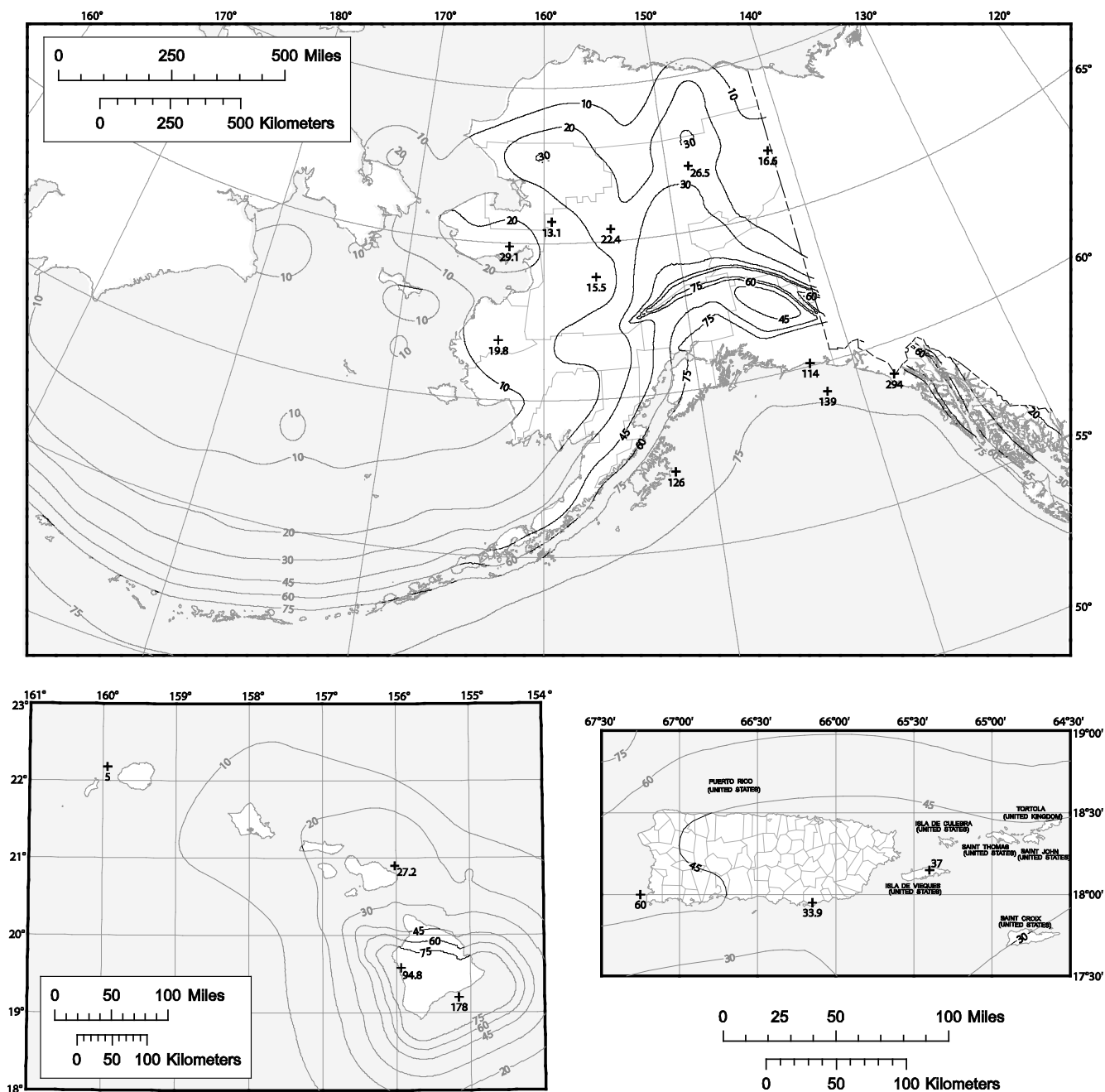

Figure 22-2 Uniform-hazard (2% in 50-Year) ground motions of 1.0-second spectral response Acceleration (5% of critical damping), Site Class B



Contours and spot values are in units of %g

Notes:

- Maps prepared by United States Geological Survey (USGS).
- Ground motion values contoured on these maps are for the maximum direction of acceleration. As such, they are different (by a factor of 1.3) from those on the 2008 USGS National Seismic Hazard Maps posted at <http://earthquake.usgs.gov/research/hazmaps/>.
- Larger, more detailed versions of these maps are not included because it is recommended that the corresponding USGS web tool (<http://earthquake.usgs.gov/designmaps/>) be used to determine the mapped value for a specified location.

Figure 22-2 (continued) Uniform-hazard (2% in 50-Year) ground motions of 1.0-second spectral response Acceleration (5% of critical damping), Site Class B

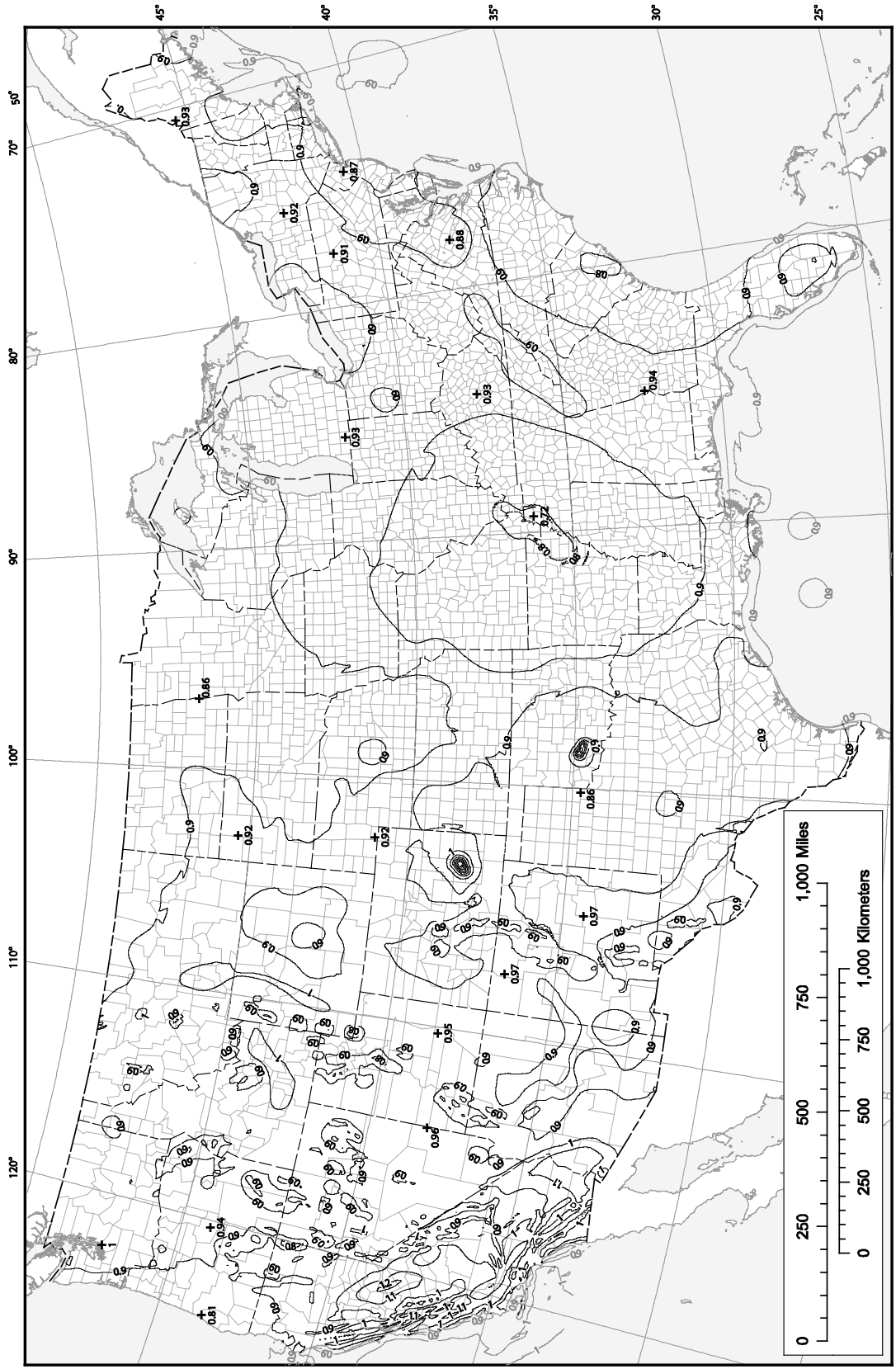
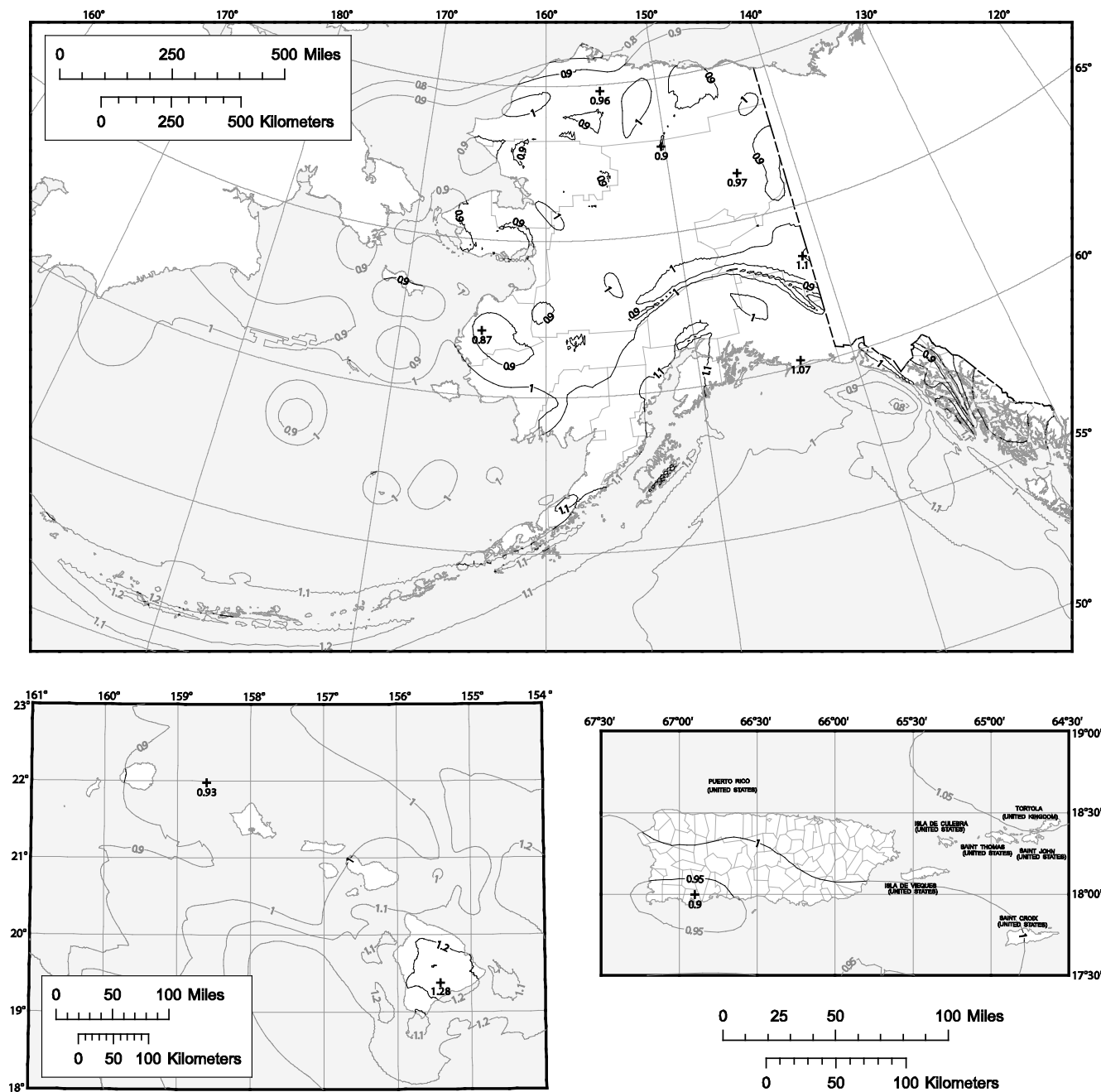

Figure 22-3 Risk coefficient at 0.2-second spectral response period



Notes:

- Maps prepared by United States Geological Survey (USGS).
- Larger, more detailed versions of these maps are not included because it is recommended that the corresponding USGS web tool (<http://earthquake.usgs.gov/designmaps/>) be used to determine the mapped value for a specified location.

Figure 22-3 (continued) Risk coefficient at 0.2-second spectral response period

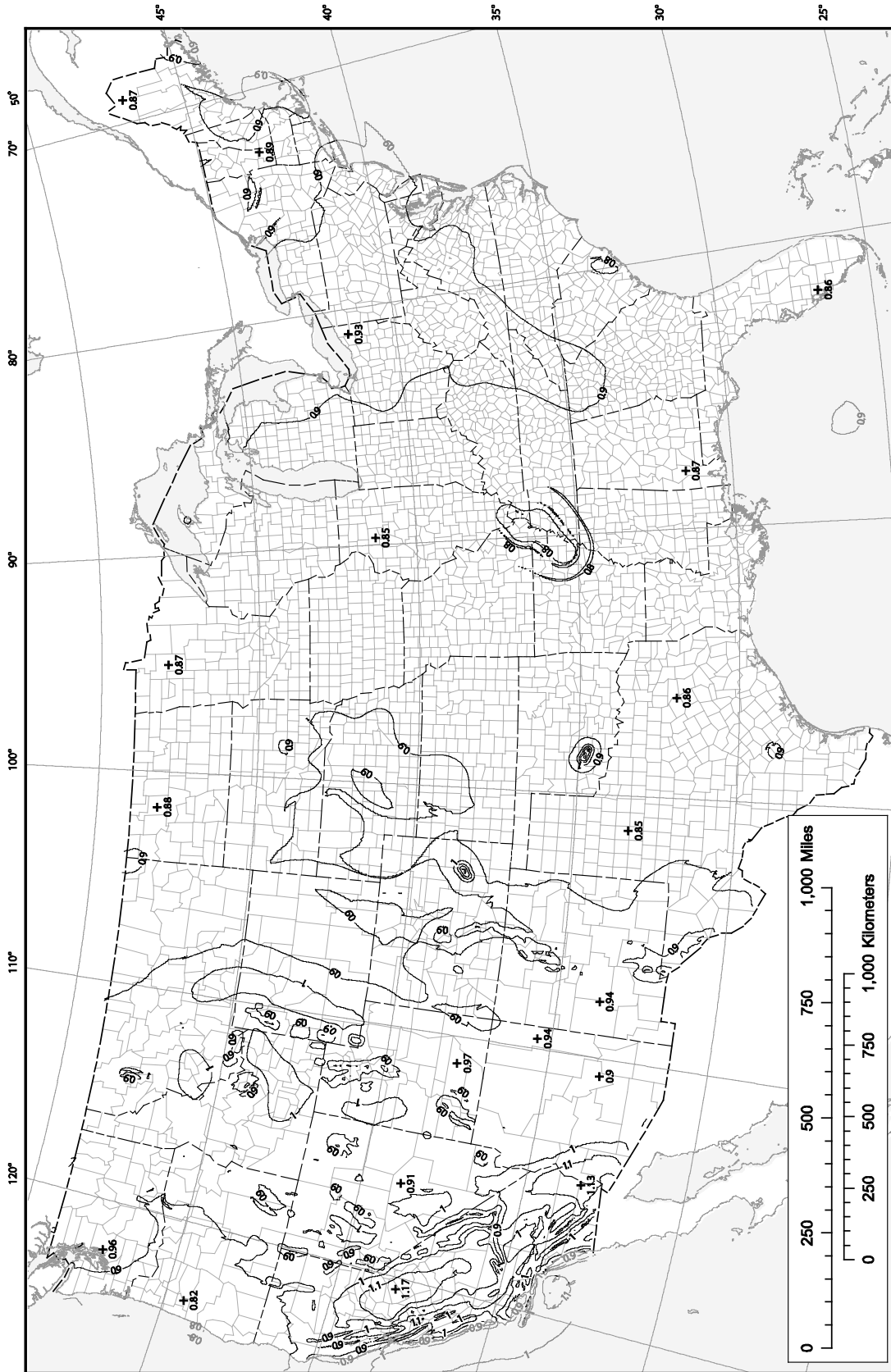
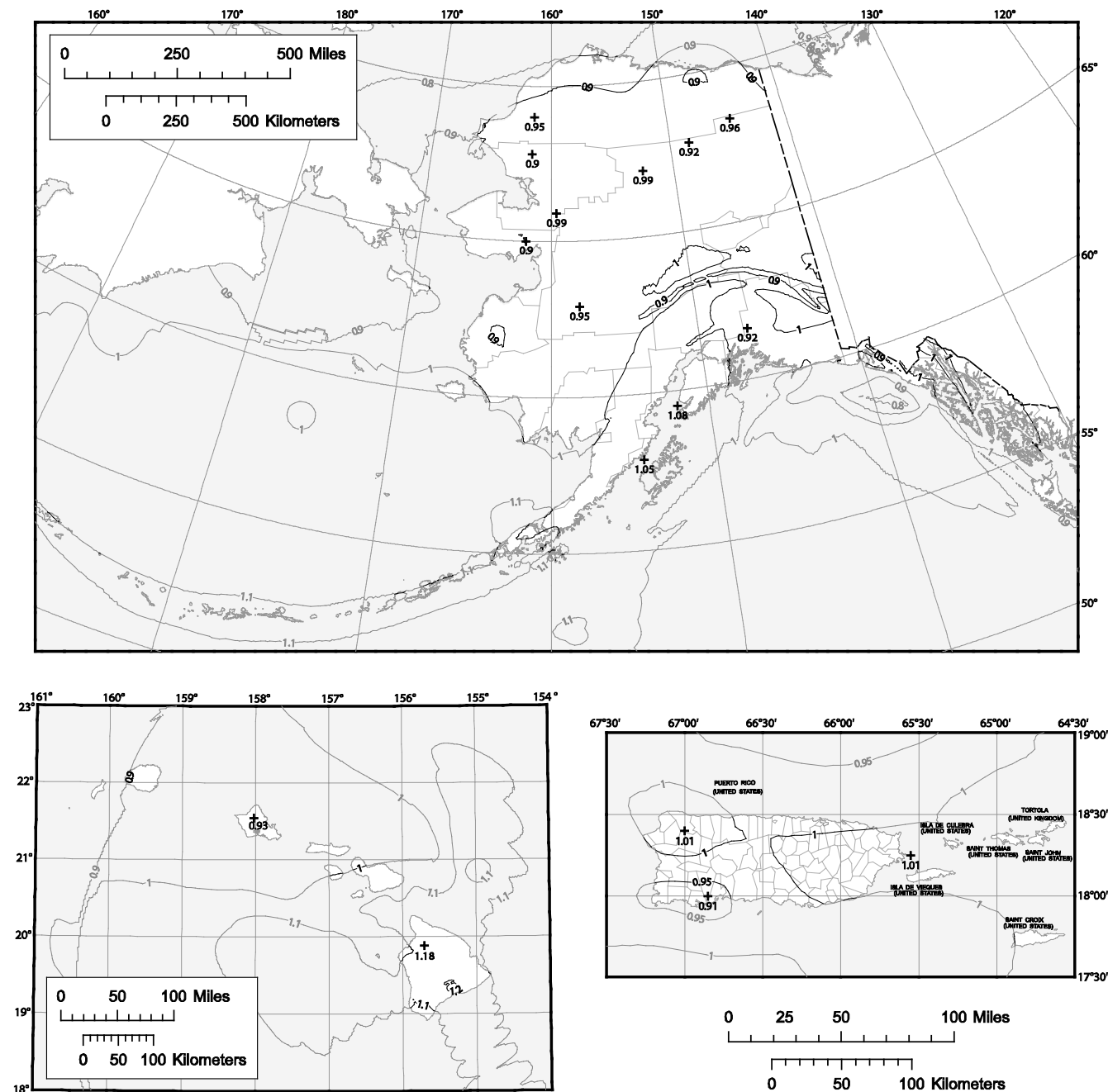

Figure 22-4 Risk coefficient at 1.0-second spectral response period



Notes:

- Maps prepared by United States Geological Survey (USGS).
- Larger, more detailed versions of these maps are not included because it is recommended that the corresponding USGS web tool (<http://earthquake.usgs.gov/designmaps/>) be used to determine the mapped value for a specified location.

Figure 22-4 (continued) Risk coefficient at 1.0-second spectral response period

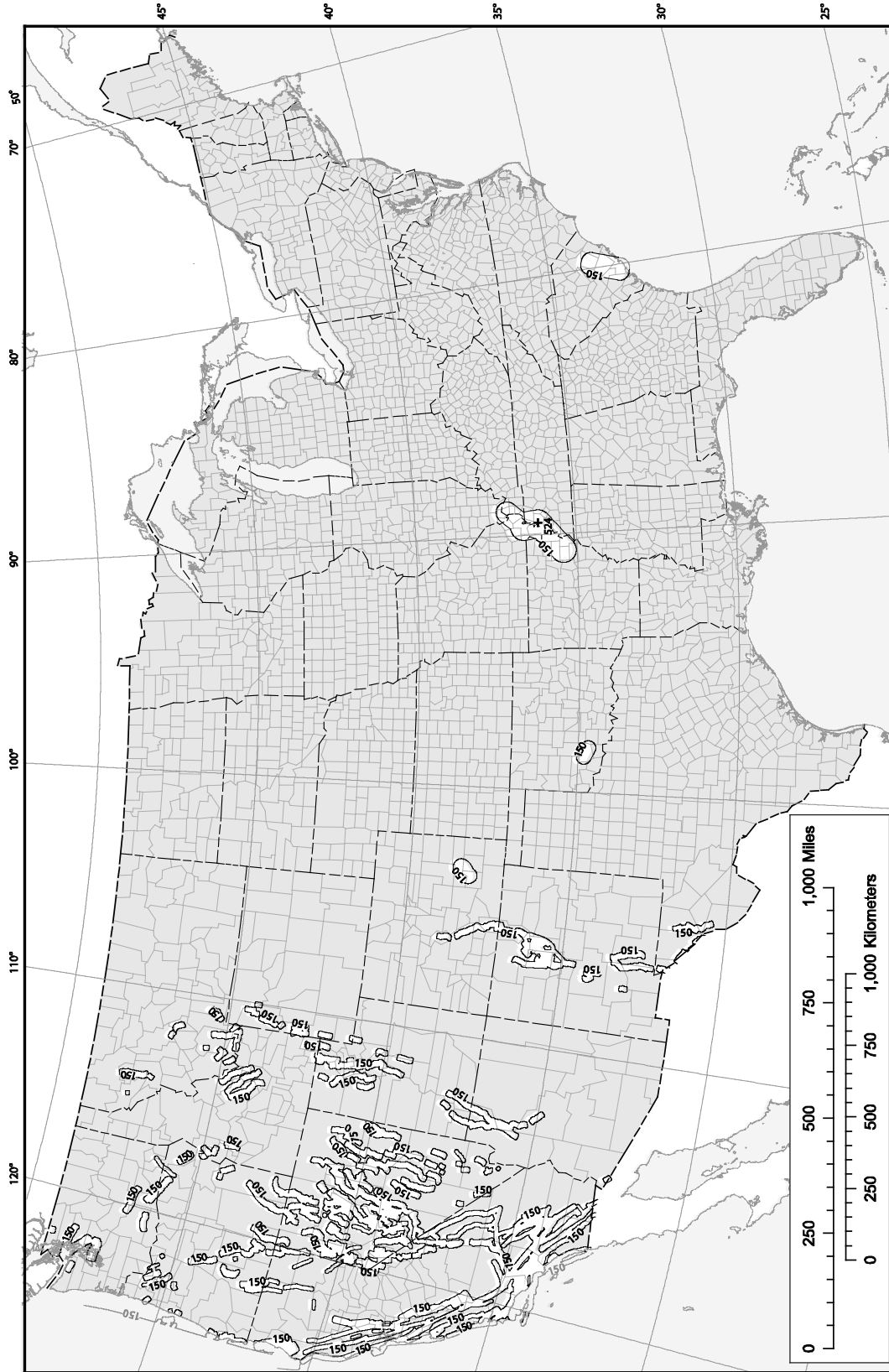
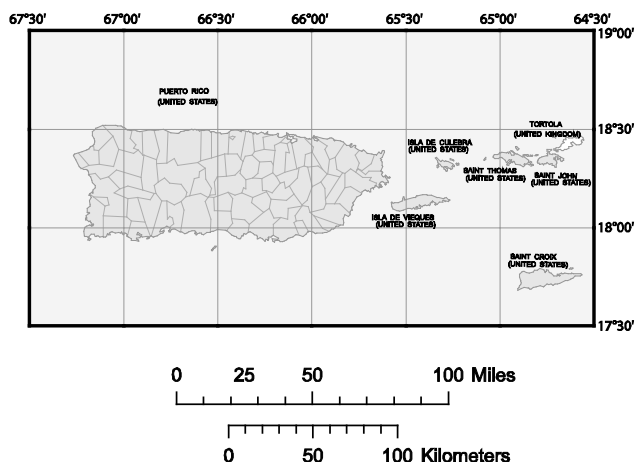
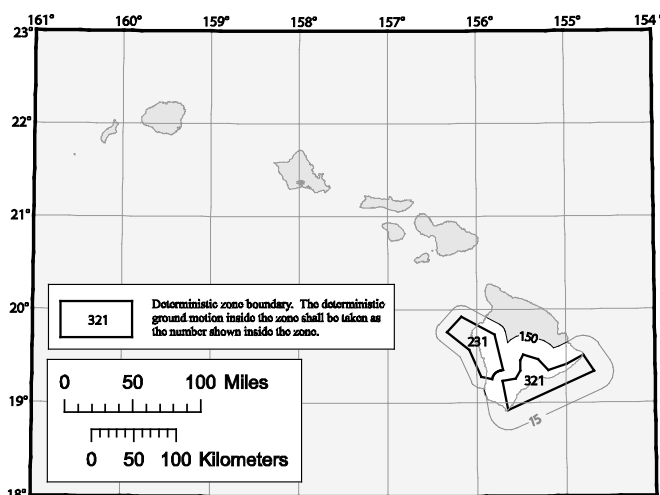
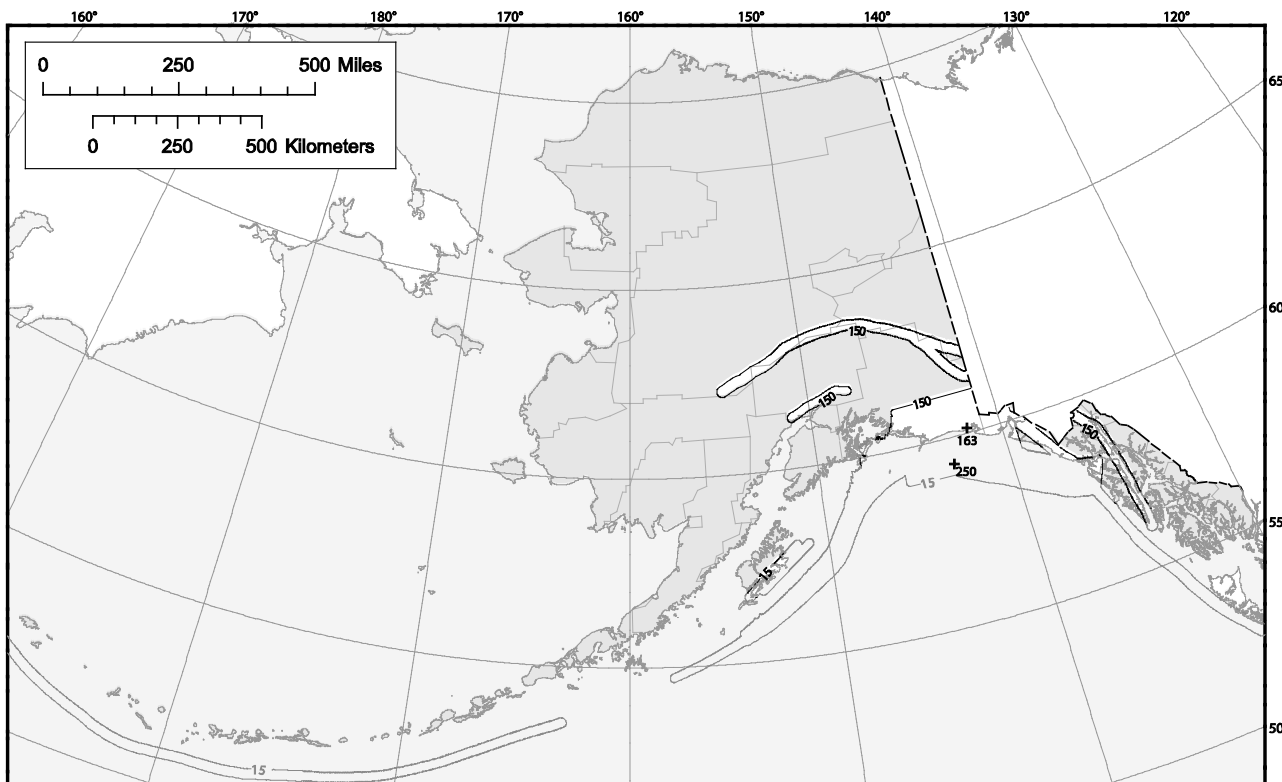

Figure 22-5 Deterministic ground motions of 0.2-second spectral response acceleration (5% of Critical Damping), Site Class B



Contours and spot values are in units of %g

Areas where the deterministic ground motions shall be taken as 150% g.

Notes:

- Maps prepared by United States Geological Survey (USGS).
- Ground motion values contoured on these maps are for the maximum direction of acceleration.
- Larger, more detailed versions of these maps are not included because it is recommended that the corresponding USGS web tool (<http://earthquake.usgs.gov/designmaps/>) be used to determine the mapped value for a specified location.

Figure 22-5 (continued) Deterministic ground motions of 0.2-second spectral response acceleration (5% of Critical Damping), Site Class B

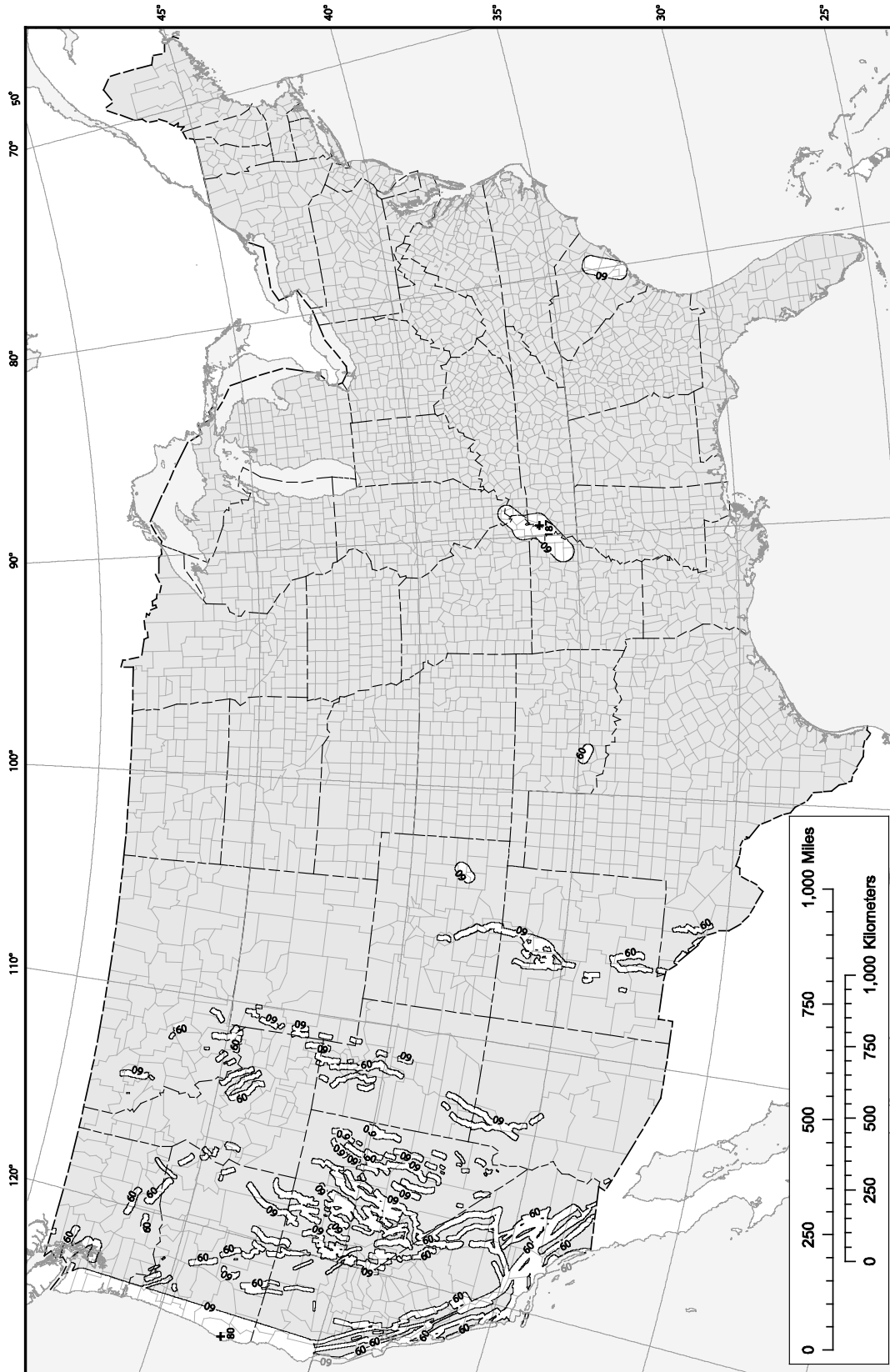
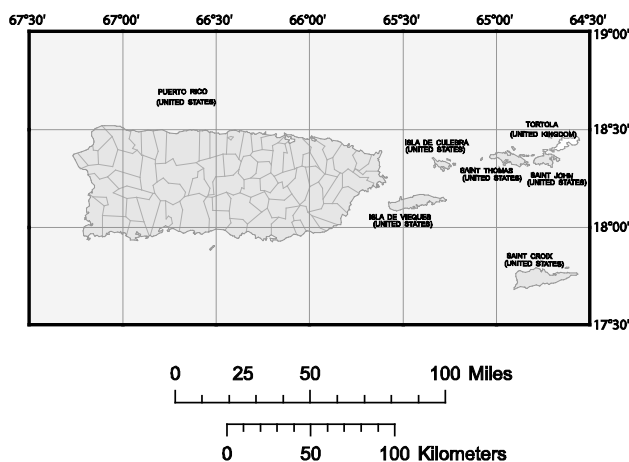
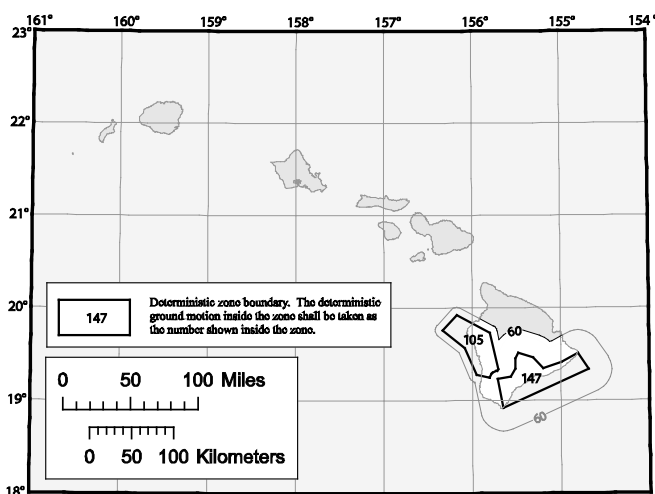
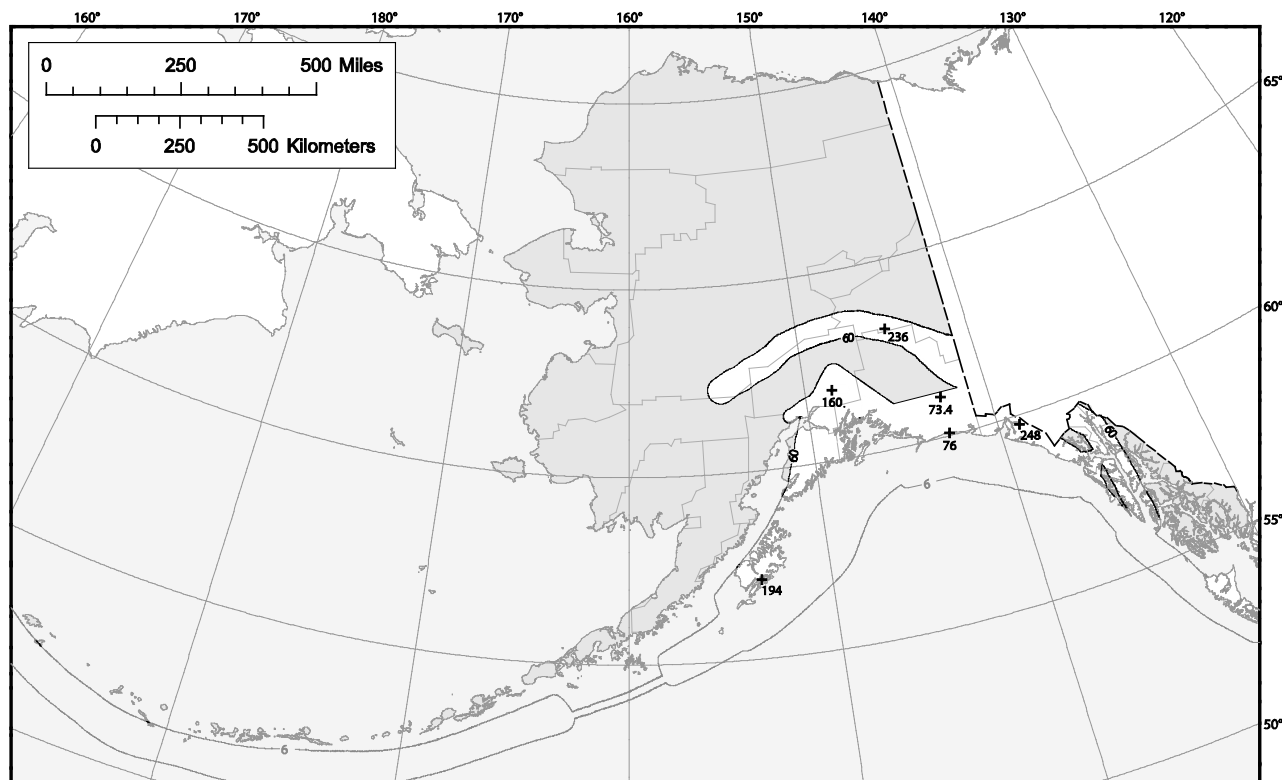

Figure 22-6 Deterministic ground motions of 1.0-second spectral response acceleration (5% of Critical Damping), Site Class B



Contours and spot values are in units of %g

Areas where the deterministic ground motions shall be taken as 60% g.

Notes:

- Maps prepared by United States Geological Survey (USGS).
- Ground motion values contoured on these maps are for the maximum direction of acceleration.
- Larger, more detailed versions of these maps are not included because it is recommended that the corresponding USGS web tool (<http://earthquake.usgs.gov/designmaps/>) be used to determine the mapped value for a specified location.

Figure 22-6 (continued) Deterministic ground motions of 1.0-second spectral response acceleration (5% of Critical Damping), Site Class B

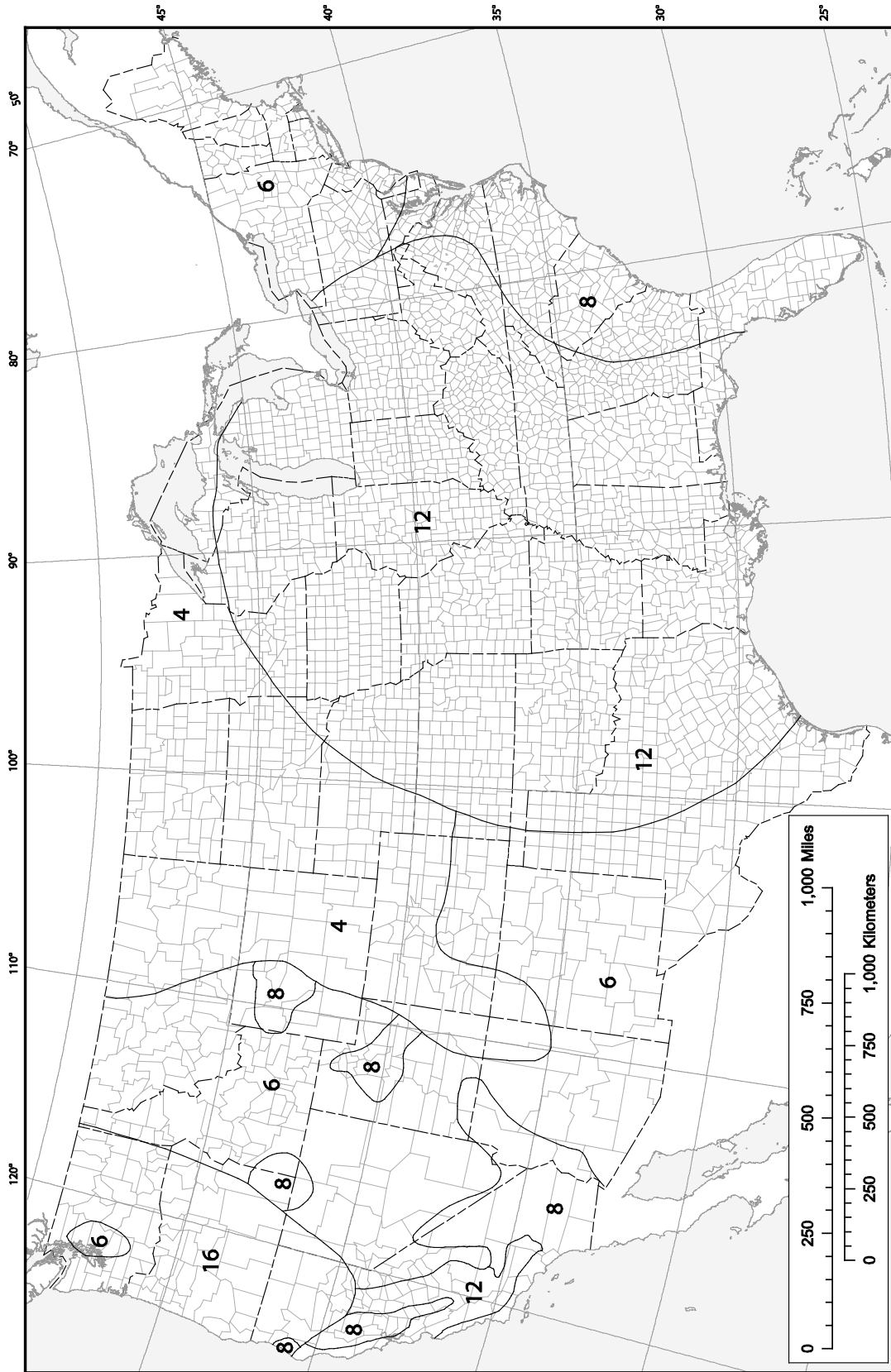
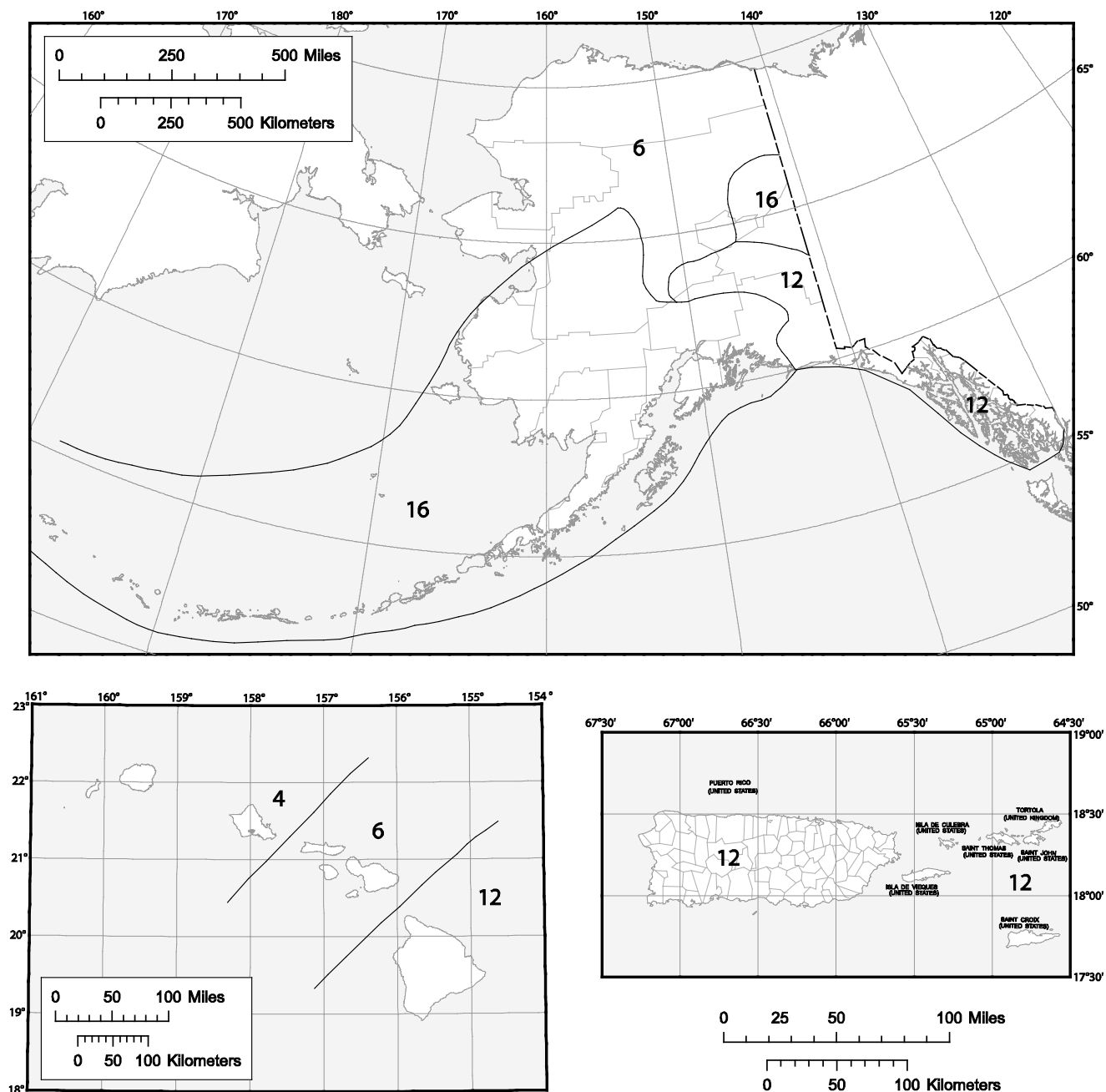

Figure 22-7 Long-period transition period, T_L (s)



Notes:

- Maps prepared by United States Geological Survey (USGS).
- For Guam and Tutuila (American Samoa), the long-period transition period, T_L , shall be 12 s.
- Larger, more detailed versions of these maps are not included because it is recommended that the corresponding USGS web tool (<http://earthquake.usgs.gov/designmaps/>) be used to determine the mapped value for a specified location.

Figure 22-7 (continued) Long-period transition period, T_L (s)

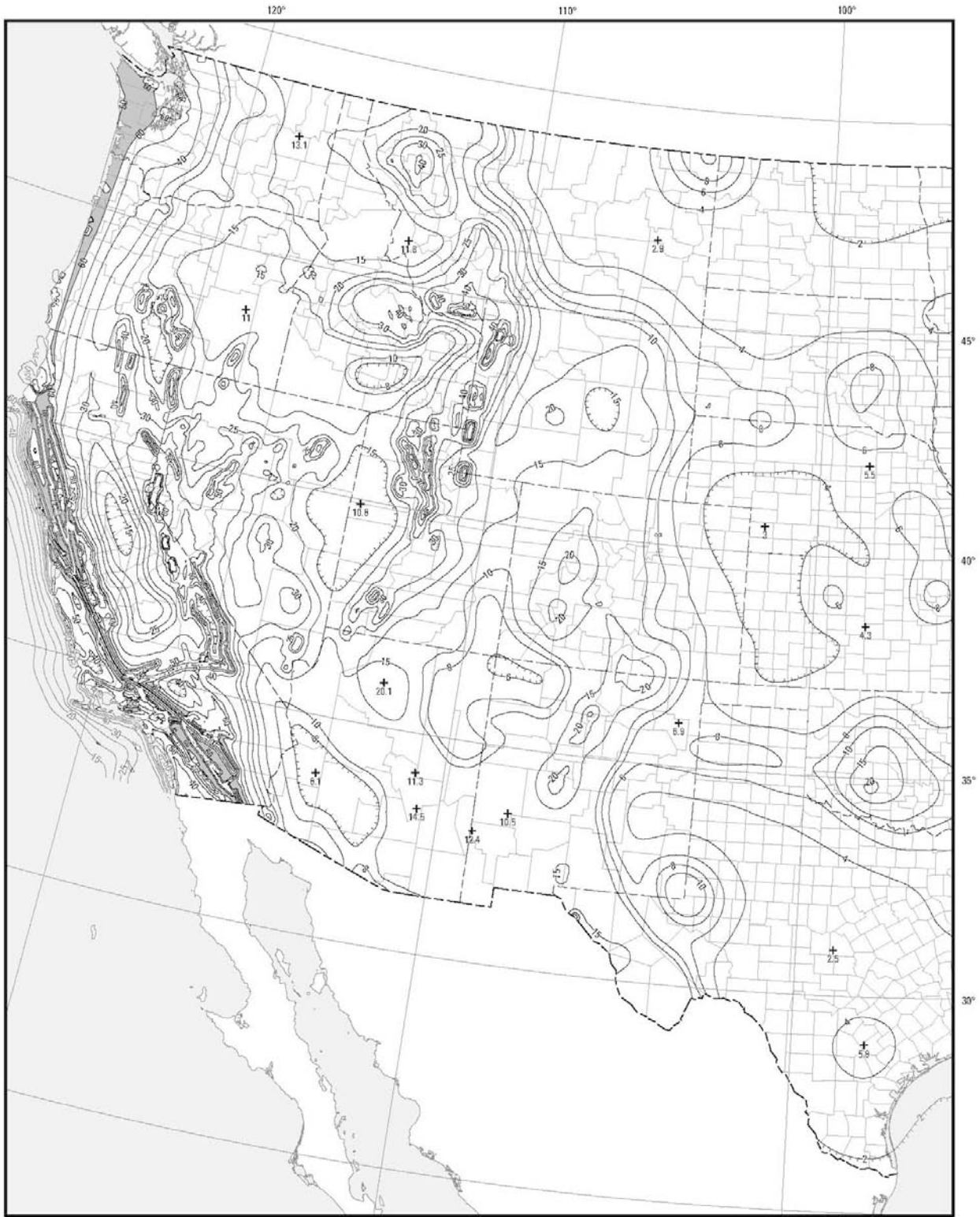

Figure 22-8 MCE geometric mean PGA, %g, Site Class B for the conterminous United States

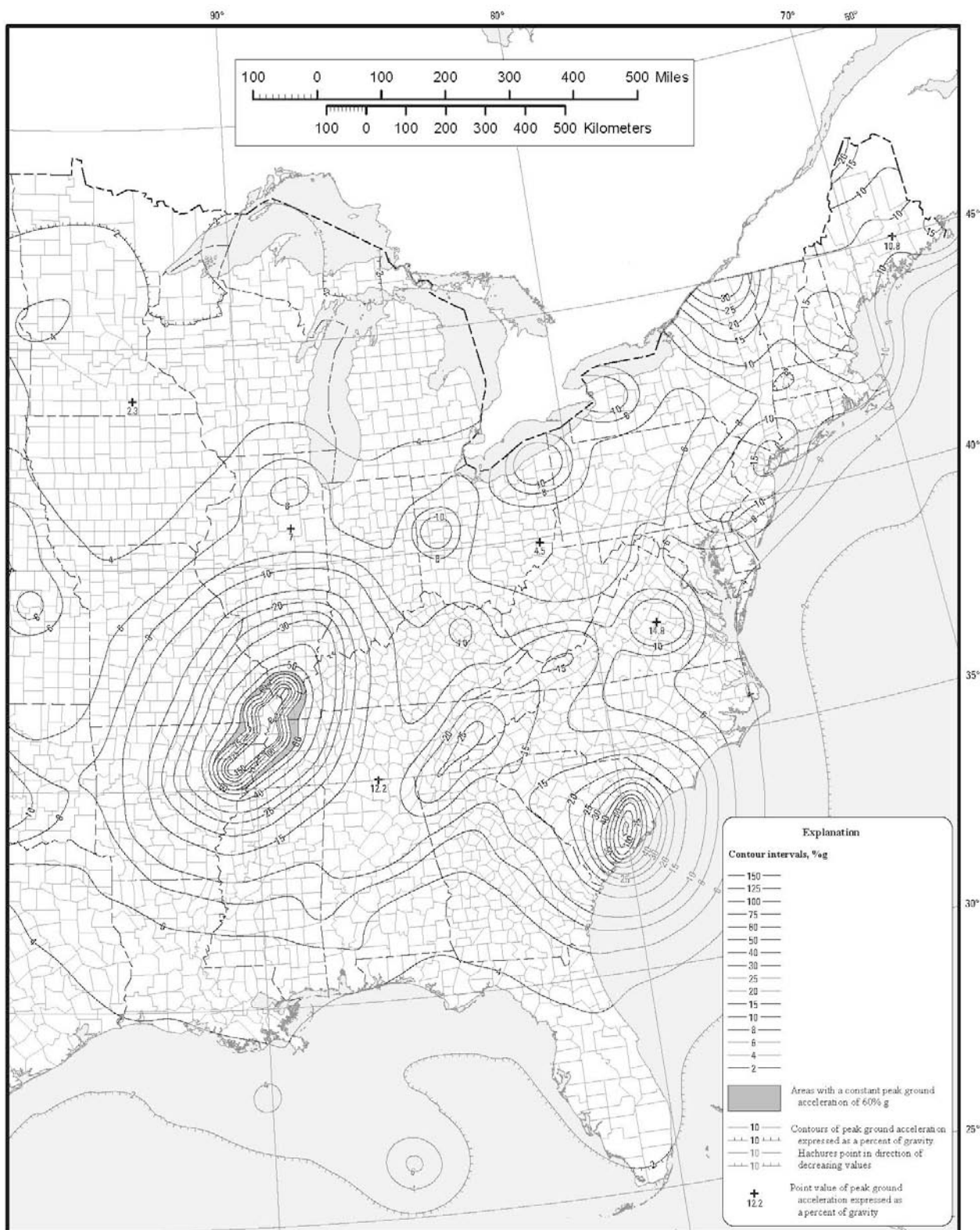

Figure 22-8 (continued) MCE geometric mean PGA, %g, Site Class B for the conterminous United States

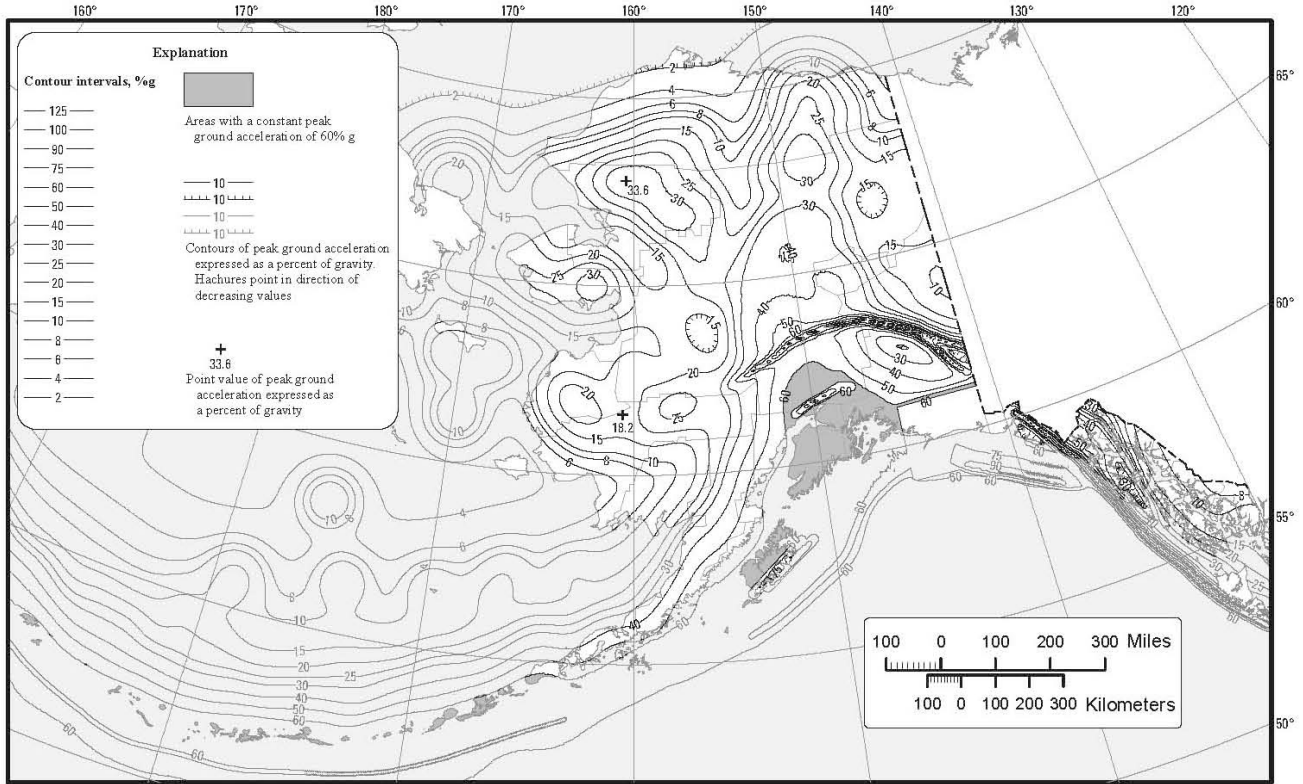

Figure 22-9 MCE geometric mean PGA, %g, Site Class B for Alaska

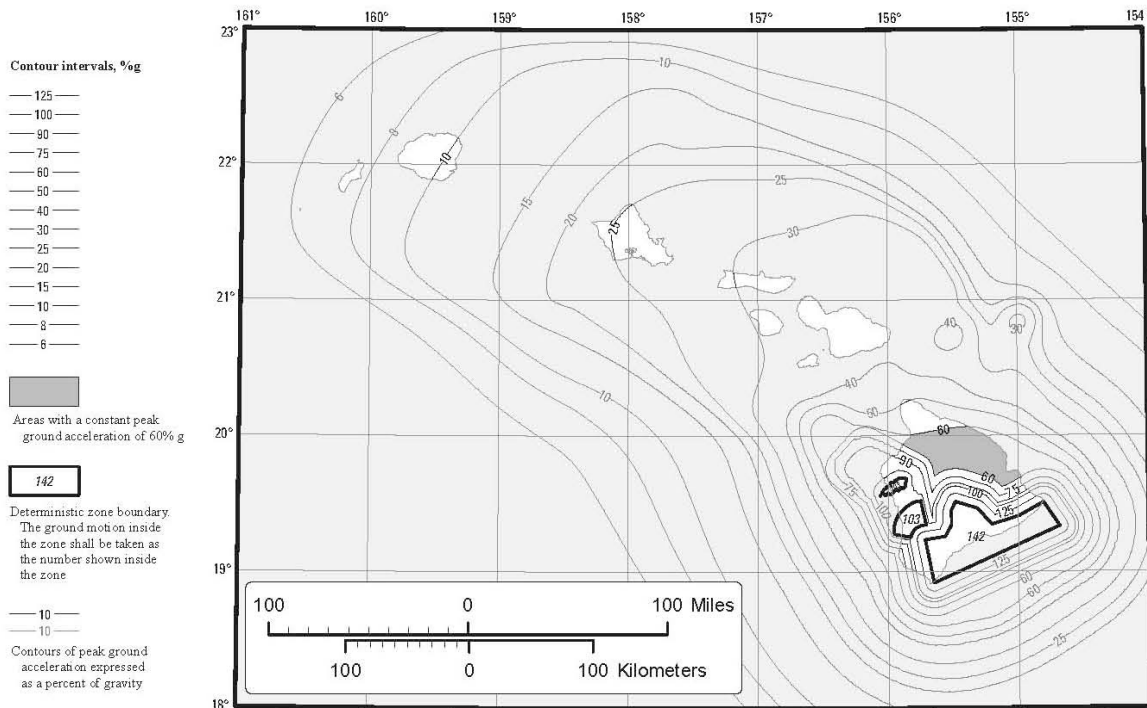

Figure 22-10 MCE geometric mean PGA, %g, Site Class B for Hawaii

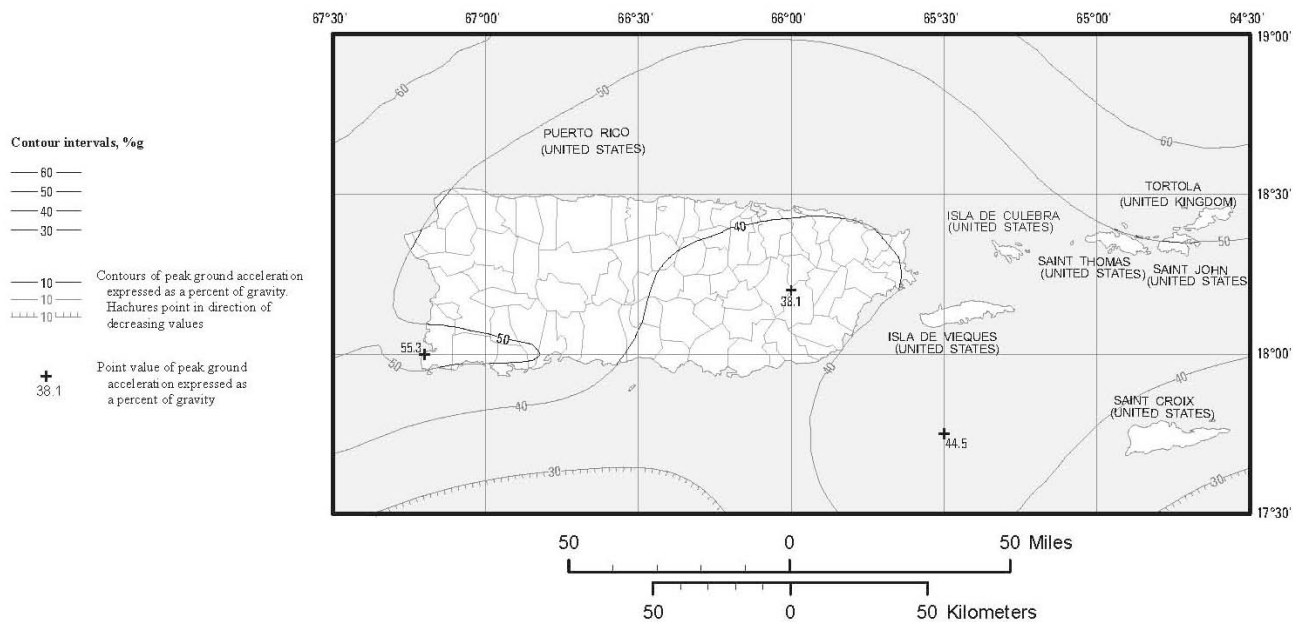

Figure 22-11 MCE geometric mean PGA, %g, Site Class B for Puerto Rico and United States Virgin Islands

Commentary to New Chapter 22

Chapter 22 Commentary SEISMIC GROUND MOTION, LONG-PERIOD TRANSITION, RISK COEFFICIENT, AND MCE GEOMEAN PGA MAPS

The USGS has prepared the four new sets of maps for Chapter 22 of the 2009 *NEHRP Recommended Seismic Provisions*:

1. Maps of uniform-hazard (2 percent in 50-year) ground motions,
2. Maps of the risk coefficients for converting 2 percent in 50-year uniform-hazard ground motions to 1 percent in 50-year risk-targeted probabilistic ground motions,
3. Maps of deterministic ground motions (consistent with site-specific criteria of Section 21.2.2), and maps of peak ground accelerations for the evaluation of the potential for liquefaction and soil strength loss (according to Section 11.8.3).

Because this would have resulted in a substantial increase in the number of maps, the BSSC Provisions Update Committee recommended that the separate maps for regions of the United States and its territories that appeared in ASCE/SEI 7-05 be consolidated (for the uniform-hazard ground motion, risk coefficient, and deterministic ground motion maps), into the single figures in Chapter 22. Thus, the total number of map figures (11) in these *Provisions* (2009) is less than that in ASCE/SEI 7-05 (i.e., 20). Because the consolidated map figures are relatively small and difficult to read, the USGS website that automates use of the maps and formulas will be especially useful (<http://earthquake.usgs.gov/designmaps/usapp>).

As described in the commentary to Chapter 21 and below, the uniform-hazard and deterministic ground motion maps in Chapter 22 of these *Provisions* (2009) represent response in the maximum direction. The USGS has developed these maps based on "geomean" ground motions (the product of hazard assessment using modern ground motion attenuation functions), adjusted using constant factors that transform geomean response to maximum direction response. The same factors (i.e., 1.1 at short-periods and 1.3 at a period of 1 second) are used for all seismic regions (i.e., both the central and eastern United States or CEUS and the western United States or WUS) and for both probabilistic and deterministic ground motions.

In contrast, the peak ground acceleration maps in Chapter 22 represent geomean ground motions, as described below. Furthermore, the peak ground acceleration maps represent the lesser of uniform-hazard (2 percent in 50-year) and deterministic peak ground accelerations, without consideration of corresponding risk coefficients.

Uniform-Hazard (2 Percent in 50-Year) Ground Motion Maps

The uniform-hazard maps in Chapter 22 of these *Provisions* (2009) are based on the 2008 USGS National Seismic Hazard Maps (<http://earthquake.usgs.gov/hazmaps>); however, since the ground motion values on the uniform-hazard maps are for the maximum direction of acceleration (as explained above), they are different from the "geomean" USGS maps. The 0.2-second and 1-second spectral response acceleration uniform-hazard maps are different by a factor of 1.1 and 1.3 from the respective USGS maps. Development of the USGS maps is documented in Petersen et al. (2008).

Risk Coefficient Maps

Development of risk coefficients and related work by the USGS is documented by Luco et al. (2007). The risk coefficient maps indicate that, in general, risk-targeted probabilistic ground motions (based on 1 percent in 50-year collapse risk) would moderately decrease the uniform-hazard ground motions (based on 2 percent in 50-year hazard) in high-hazard areas of the CEUS and the coastal region of Oregon (by as much as 30 percent) and either slightly increase or decrease the uniform-hazard ground motions in the WUS and remaining areas of the maps (by less than 15 percent). These changes do not affect calculation of deterministic ground motions, which often govern in high seismic areas.

Deterministic Ground Motion Maps

The deterministic maps in Chapter 22 of the *Provisions* represent the greater of 84th percentile (maximum direction) response and the "water level" values described in the next paragraph. The USGS has developed these maps based on median "geomean" ground motions (the product of hazard assessment using modern ground motion attenuation functions) adjusted using factors that transform median geomean-direction response to 84th percentile maximum-direction response. The same factors (i.e., 1.1 x 1.8 at short-periods and 1.3 x 1.8 at a period of 1 second) are used for all seismic regions (i.e., both the CEUS and WUS regions).

As defined in ASCE/SEI 7-05 Section 21.2.2, the deterministic spectral response accelerations (for Site Class B) shall not be taken as lower than 1.5g for the short periods and 0.6g for the 1-second period; hence, the ground motions on the deterministic maps (Figures 22-3 and 22-4) are no lower than these values. Otherwise the ground motions on the deterministic maps are 180 percent (as opposed 150 percent in ASCE/SEI 7-05) of median spectral response accelerations,

for reasons explained above in the commentary to Chapter 21. Like the uniform-hazard maps described above, the deterministic maps represent the spectral response acceleration in the maximum direction.

Peak Ground Acceleration Maps

Unlike the uniform-hazard and deterministic ground motion maps described above, the peak ground acceleration maps in Chapter 22 of the *Provisions* represent geometric mean ground motions (not response in the maximum direction). Despite representing geometric mean ground motions, the peak ground acceleration maps are different from the 2008 USGS National Seismic Hazard Maps (<http://earthquake.usgs.gov/hazmaps>) upon which they are based. This is because they represent the lesser of uniform-hazard (2 percent in 50-year hazard) and deterministic peak ground accelerations. Development of the uniform-hazard peak ground accelerations is documented in Petersen et al. (2008). The deterministic peak ground accelerations are calculated as the greater of 180 percent of median ground motions and a water level of 0.6g. Note that risk coefficients are not included in the development of the peak ground acceleration maps, which is why they are referred to as “maximum considered earthquake geometric mean peak ground acceleration” maps without the “risk-targeted” prefix.

REFERENCES

American Society of Civil Engineers. 2006. *Minimum Design Loads for Buildings and Other Structures*, ASCE/SEI 7-05. ASCE, Reston, Virginia.

Luco, N., B. R. Ellingwood, R. O. Hamburger, J. D. Hooper, J. K. Kimball and C. A. Kircher. 2007. “Risk-Targeted versus Current Seismic Design Maps for the Conterminous United States,” in *Proceedings of the SEAOC 76th Annual Convention*. Structural Engineers Association of California, Sacramento, California.

Petersen, M. D., A. D. Frankel, S. C. Harmsen, C. S. Mueller, K. M. Haller, R. L. Wheeler, R. L. Wesson, Y. Zeng, O. S. Boyd, D. M. Perkins, N. Luco, E. H. Field, C. J. Wills, and K. S. Rukstales. 2008. *Documentation for the 2008 Update of the United States National Seismic Hazard Maps*, USGS Open File Report 2008-1128. USGS, Golden, Colorado.

Page intentionally left blank.

Modifications to Chapter 23, Seismic Design Reference Documents

SECTION 23.1, CONSENSUS STANDARDS AND OTHER REFERENCE DOCUMENTS

Add the following entries:

ASCE 41

Supplement 1, Section 3.3.3

Seismic Rehabilitation of Existing Buildings, 2007

ANSI/AISI S110

Sections 14.1.1, 14.1.2, 14.1.3, Table 12.2-1

Standard for Seismic Design of Cold-Formed Steel Structural Systems – Special Bolted Moment Frames, 2007.

ANSI/RMI MH 16.1

Section 15.5.3

Specification for the Design, Testing, and Utilization of Industrial Steel Storage Racks, 2008

Revise the following entries to read as indicated:

ACI 318

Sections 14.2.2, 14.2.2.1, 14.2.2.2, 14.2.2.3, 14.2.2.4, 14.2.2.5, 14.2.2.6, 14.2.2.7, 14.2.2.8, 14.2.2.9, 14.2.3, 14.2.3.1.1, 14.2.3.2.1, 14.2.3.2.2, 14.2.3.2.3, 14.2.3.2.5, 14.2.3.2.

Building Code Requirements for Structural Concrete, 2008.

NFPA 13

Sections 13.6.5.1, 13.6.8, 13.6.8.2, 13.6.8.4

Standard for the Installation of Sprinkler Systems, 2007

Delete the following entry:

RMI

Rack Manufacturers Institute

8720 Red Oak Boulevard

Suite 201

Charlotte, NC 28217

RMI

Section 15.5.3

Specification for the Design, Testing, and Utilization of Industrial Steel Storage Racks 1997, reaffirmed 2002

Page intentionally left blank.

New Chapter 23, Vertical Ground Motions for Seismic Design

Add the following new Chapter 23 and renumber the existing ASCE/SEI 7-05 Chapter 23 as Chapter 24:

Chapter 23

VERTICAL GROUND MOTIONS FOR SEISMIC DESIGN

23.1 DESIGN VERTICAL RESPONSE SPECTRUM. Where a design vertical response spectrum is required by these *Provisions* and site-specific procedures are not used, the design vertical response spectral acceleration, S_{av} , (in g – gravity unit) shall be developed as follows:

1. For vertical periods less than or equal to 0.025 second, S_{av} shall be determined in accordance with Equation 23.1-1 as follows:

$$S_{av} = 0.3C_v S_{DS} \quad (23.1-1)$$

2. For vertical periods greater than 0.025 second and less than or equal to 0.05 second, S_{av} shall be determined in accordance with Equation 23.1-2 as follows:

$$S_{av} = 20C_v S_{DS}(T_V - 0.025) + 0.3C_v S_{DS} \quad (23.1-2)$$

3. For vertical periods greater than 0.05 second and less than or equal to 0.15 second, S_{av} shall be determined in accordance with Equation 23.1-3 as follows:

$$S_{av} = 0.8C_v S_{DS} \quad (23.1-3)$$

4. For vertical periods greater than 0.15 second and less than or equal to 2.0 seconds, S_{av} shall be determined in accordance with Equation 23.1-4 as follows:

$$S_{av} = 0.8C_v S_{DS} \left(\frac{0.15}{T_V} \right)^{0.75} \quad (23.1-4)$$

where C_v is defined in terms of S_S in Table 23.1-1, S_{DS} = the design spectral response acceleration parameter at short periods, and T_V = the vertical period of vibration.

Table 23.1-1 Values of Vertical Coefficient C_v

MCE _R Spectral Response Parameter at Short Periods ^a	Site Class A, B	Site Class C	Site Class D, E, F
$S_S \geq 2.0$	0.9	1.3	1.5
$S_S = 1.0$	0.9	1.1	1.3
$S_S = 0.6$	0.9	1.0	1.1
$S_S = 0.3$	0.8	0.8	0.9
$S_S \leq 0.2$	0.7	0.7	0.7

^a Use straight-line interpolation for intermediate values of S_S .

S_{av} shall not be less than one-half (1/2) of the corresponding S_a for horizontal components determined in accordance with the general or site-specific procedures of Section 11.4 or Chapter 21, respectively.

For vertical periods greater than 2.0 seconds, S_{av} shall be developed from a site-specific procedure; however, the resulting ordinate of S_{av} shall not be less than one-half (1/2) of the corresponding S_a for horizontal components determined in accordance with the general or site-specific procedures of Section 11.4 or Chapter 21, respectively.

In lieu of using the above procedure, a site-specific study may be performed to obtain S_{av} at vertical periods less than or equal to 2.0 seconds, but the value so determined shall not be less than 80 percent of the S_{av} value determined from Equations 23.1-1 through 23.1-4.

23.2 MCE_R VERTICAL RESPONSE SPECTRUM. The MCE_R vertical response spectral acceleration shall be 150 percent of the S_{av} determined in Section 23.1.

Commentary to New Chapter 23

Chapter 23 Commentary VERTICAL GROUND MOTIONS FOR SEISMIC DESIGN

C23.1 DESIGN VERTICAL RESPONSE SPECTRUM

General. ASCE/SEI 7-05 and the earlier editions of the *Provisions* use the term $0.2S_{DS}D$ to reflect the effects of vertical ground motion. Where a more explicit consideration of vertical ground motion effects is advised—as for certain tanks, materials storage facilities, and electric power generation facilities—the requirements of this chapter may be applied. Historically, the amplitude of vertical ground motion has been inferred to be two-thirds (2/3) the amplitude of the horizontal ground motion. However, studies of horizontal and vertical ground motions over the past 25 years have shown that such a simple approach is not valid in many situations (e.g., Bozorgnia and Campbell, 2004, and references therein) for the following main reasons: (a) vertical ground motion has a larger proportion of short-period (high-frequency) spectral content than horizontal ground motion and this difference increases with decreasing soil stiffness and (b) vertical ground motion attenuates at a higher rate than horizontal ground motion and this difference increases with decreasing distance from the earthquake.

The observed differences in the spectral content and attenuation rate of vertical and horizontal ground motion lead to the following observations regarding the vertical/horizontal (V/H) spectral ratio (Bozorgnia and Campbell, 2004):

1. The V/H spectral ratio is relatively sensitive to spectral period, distance from the earthquake, local site conditions, and earthquake magnitude (but only for relatively soft sites) and relatively insensitive to earthquake mechanism and sediment depth;
2. The V/H spectral ratio has a distinct peak at short periods that generally exceeds 2/3 in the near-source region of an earthquake; and
3. The V/H spectral ratio is generally less than 2/3 at mid-to-long periods.

Therefore, depending on the period, the distance to the fault, and the local site conditions of interest, use of the traditional $2/3V/H$ spectral ratio can result in either an underestimation or an overestimation of the expected vertical ground motions.

The procedure for defining the design vertical response spectrum in the *Provisions* is based on the studies of horizontal and vertical ground motions conducted by Campbell and Bozorgnia (2003) and Bozorgnia and Campbell (2004). These procedures are also generally compatible with the general observations of Abrahamson and Silva (1997) and Silva (1997) and the proposed design procedures of Elnashai (1997).

General Design Procedure. In order to be consistent with the shape of the horizontal design response spectrum, the vertical design response spectrum has four regions defined by the vertical period of vibration (T_v). Based on the study of Bozorgnia and Campbell (2004), the periods that define these regions are approximately constant with respect to the magnitude of the earthquake, the distance from the earthquake, and the local site conditions. In this respect, the shape of the vertical response spectrum is simpler than that of the horizontal response spectrum.

The equations that are used to define the design vertical response spectrum are based on three observations made by Bozorgnia and Campbell (2004):

1. The short-period part of the 5 percent damped vertical response spectrum is controlled by the spectral acceleration at $T_v = 0.1$ second;
2. The mid-period part of the vertical response spectrum is controlled by a spectral acceleration that decays as the inverse of the 0.75 power of the vertical period of vibration ($T_v^{-0.75}$); and
3. The short-period part of the V/H spectral ratio is a function of the local site conditions, the distance from the earthquake (for sites located within about 60 km of the fault), and the earthquake magnitude (for soft sites).

The *Provisions* do not include seismic design maps for the vertical spectral acceleration at $T_v = 0.1$ second and do not preserve any information on the earthquake magnitudes or the source-to-site distances that contribute to the horizontal spectral accelerations that are mapped. Therefore, the general procedure recommended by Bozorgnia and Campbell (2004) was modified to use only those horizontal spectral accelerations that are available from the seismic design maps, as follows:

1. Estimate the vertical spectral acceleration at $T_v = 0.1$ second from the ratio of this spectral acceleration to the horizontal spectral acceleration at $T = 0.2$ second for the Site Class BC boundary (i.e., the boundary between Site Classes B and C ($\bar{v}_s = 760$ m/sec), the reference site condition for the 2008 U.S. Geological Survey National Seismic Hazard Maps). For earthquakes and distances for which the vertical spectrum might be of engineering interest (magnitudes greater than 6.5 and distances less than 60 km), this ratio is approximately 0.8 for all site conditions (Campbell and Bozorgnia, 2003).
2. Estimate the horizontal spectral acceleration at $T = 0.2$ second from the Next Generation Attenuation (NGA) relationship of Campbell and Bozorgnia (2008) for magnitudes greater than 6.5 and distances ranging between 1 and 60 km for the Site Class BC boundary ($\bar{v}_s = 760$ m/sec). The relationship of Campbell and Bozorgnia (2008), rather than that of Campbell and Bozorgnia (2003), was used for this purpose in order to be consistent with the development of the 2008 U.S. Geological Survey National Seismic Hazard Maps, which use the NGA attenuation relationships to estimate horizontal ground motions in the western United States. Similar results were found for the other two NGA relationships that were used to develop the seismic hazard and design maps (Boore and Atkinson, 2008; Chiou and Youngs, 2008).
3. Use the dependence between the horizontal spectral acceleration at $T = 0.2$ second and source-site distance estimated in Item 2 and the relationship between the V/H spectral ratio, source-site distance, and local site conditions in Bozorgnia and Campbell (2004) to derive a relationship between the vertical spectral acceleration and the mapped MCE_R spectral response acceleration parameter at short periods, S_S .
4. Use the dependence between the vertical spectral acceleration and the mapped MCE_R spectral response acceleration parameter at short periods, S_S , in Item 3 to derive a vertical coefficient, C_v , that when multiplied by 0.8 and the design horizontal response acceleration at short periods, S_{DS} , results in an estimate of the design vertical spectral acceleration at $T_v = 0.1$ second.

Detailed Design Procedure. The following description of the detailed design procedure listed in Section 23.1 refers to the illustrated design vertical response spectrum in Figure C23.1-1.

Vertical periods less than or equal to 0.025 second. Equation 23.1-1 defines that part of the design vertical response spectrum that is controlled by the vertical peak ground acceleration. The 0.3 factor was approximated by dividing the 0.8 factor that represents the ratio between the vertical spectral acceleration at $T_v = 0.1$ second and the horizontal spectral acceleration at $T = 0.2$ second by 2.5, the factor that represents the ratio between the design horizontal spectral acceleration at $T = 0.2$ second, S_{DS} , and the zero-period acceleration used in the development of the design horizontal response spectrum. The vertical coefficient, C_v , in Table 23.1-1 accounts for the dependence of the vertical spectral acceleration on the amplitude of the horizontal spectral acceleration and the site dependence of the V/H spectral ratio as determined in Items 3 and 4 above. The factors are applied to S_{DS} rather than to S_S because S_{DS} already includes the effects of local site conditions and the 2/3 factor that is required to reduce the horizontal spectral acceleration from its MCE_R value to its design value.

Vertical periods greater than 0.025 second and less than or equal to 0.05 second. Equation 23.1-2 defines that part of the design vertical response spectrum that represents the linear transition from the part of the spectrum that is controlled by the vertical peak ground acceleration and the part of the spectrum that is controlled by the dynamically amplified short-period spectral plateau. The factor of 20 is the factor that is required to make this transition continuous and piecewise linear between these two adjacent parts of the spectrum.

Vertical periods greater than 0.05 second and less than or equal to 0.15 second. Equation 23.1-3 defines that part of the design vertical response spectrum that represents the dynamically amplified short-period spectral plateau.

Vertical periods greater than 0.15 second and less than or equal to 2.0 seconds. Equation 23.1-4 defines that part of the design vertical response spectrum that decays with the inverse of the vertical period of vibration raised to the 0.75 power.

Limits Imposed on S_{av} . Two limits are imposed on the design vertical response spectrum defined by Equations 23.1-1 through 23.1-4 and illustrated in Figure 23.1-1. The first limit restricts the vertical period of vibration to be no larger than 2 seconds. This limit accounts for the fact that such large vertical periods are rare (structures are inherently stiff in the vertical direction) and that the vertical spectrum might decay differently with period at longer periods. There is an allowance for developing a site-specific design vertical response spectrum if this limit is exceeded (see Section 11.4 or Chapter 21 for guidance on applying site-specific methods). The second limit restricts the design vertical response spectrum to be no less than 50 percent of the design horizontal response spectrum. This limit accounts for the fact that a V/H spectral ratio of one-half (1/2) is a reasonable, but somewhat conservative, lower bound over the period range of interest, based on the results of Campbell and Bozorgnia (2003) and Bozorgnia and Campbell (2004).

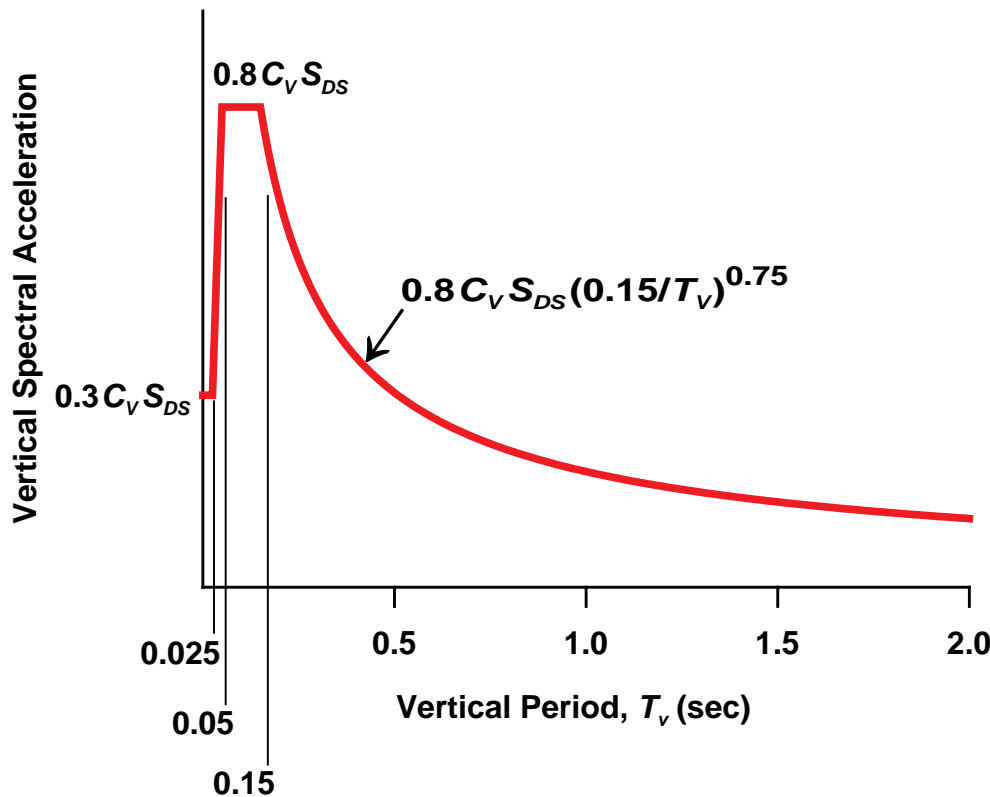

Figure C23.1-1 Illustrative example of the design vertical response spectrum.

REFERENCES

- Abrahamson, N. A., and W. J. Silva. 1997. "Empirical Response Spectral Attenuation Relations for Shallow Crustal Earthquakes," *Seismological Research Letters*, 68:94–127.
- Boore, D. M., and G. M. Atkinson. 2008. "Ground-Motion Prediction Equations for the Average Horizontal Component of PGA, PGV, and 5%-Damped PSA at Spectral Periods Between 0.01 S and 10.0 s", *Earthquake Spectra*, 24:99-138.
- Bozorgnia, Y., and K. W. Campbell. 2004. "The Vertical-to-Horizontal Response Spectral Ratio and Tentative Procedures for Developing Simplified V/H and Vertical Design Spectra," *Journal of Earthquake Engineering*, 8:175-207.
- Campbell, K. W., and Y. Bozorgnia. 2008. "NGA Ground Motion Model for the Geometric Mean Horizontal Component of PGA, PGV, PGD and 5% Damped Linear Elastic Response Spectra for Periods Ranging from 0.01 to 10 s," *Earthquake Spectra*, 24:139-171.
- Campbell, K. W., and Y. Bozorgnia. 2003. "Updated Near-source Ground Motion (Attenuation) Relations for the Horizontal and Vertical Components of Peak Ground Acceleration and Acceleration Response Spectra," *Bulletin of the Seismological Society of America*, 93:314–331.
- Chiou, B. S.-J., and R. R. Youngs. 2008. "An NGA Model for the Average Horizontal Component of Peak Ground Motion and Response Spectra," *Earthquake Spectra*, 24:173-215.
- Elnashai, A. S. 1997. "Seismic Design with Vertical Earthquake Motion," in *Seismic Design for the Next Generation of Codes*, edited by P. Fajfar and H. Krawinkler. Balkema, Rotterdam, p. 91–100.
- Silva, W. 1997. "Characteristics of Vertical Strong Ground Motions for Applications to Engineering Design," in *FHWA/NCEER Workshop on the National Representation of Seismic Ground Motion for New and Existing Highway Facilities*, Technical Report NCEER-97-0010. National Center for Earthquake Engineering Research, Buffalo, New York.

2009 NEHRP RECOMMENDED SEISMIC PROVISIONS FOR NEW BUILDINGS AND OTHER STRUCTURES:

PART 2, COMMENTARY TO ASCE/SEI 7-05

This part of the 2009 NEHRP Recommended Seismic Provisions for New Buildings and Other Structures presents commentary to ASCE/SEI 7-05 utilizing the chapter and section numbers of that standard. Commentary to the modifications of the standard that appear in Part 1 of this Provisions volume is presented at the end of each chapter of modifications and can be used to replace or add to this Part 2 Commentary (e.g., this Part 2 Commentary addresses the maps that appear in ASCE/SEI 7-05, not the new risk-targeted maps and procedures presented in Part 1 of this volume).

This commentary is intended primarily for design professionals and members of the codes- and standards-development community. However, an understanding of the basis for the seismic regulations contained in the nation's building codes and standards is important to many outside this technical community including elected officials and other decision makers responsible for aspects of the built environment, the financial and insurance communities, and individual business owners and other citizens. These individuals and others who do not have in-depth technical knowledge may find a complementary report that presents a brief overview of the 2009 Provisions of interest. This overview is published as FEMA P-749, Concepts of Earthquake-resistant Design: An Introduction to the NEHRP Recommended Seismic Provisions for New Buildings and Other Structures.

Page intentionally left blank.

COMMENTARY TO CHAPTER 11, SEISMIC DESIGN CRITERIA

C11.1 GENERAL

C11.1.1 Purpose. When prescribed wind loading governs the stress or drift design, the resisting system still must conform to the special requirements for seismic-force-resisting systems. This is required in order to resist, in a ductile manner, potential seismic loads in excess of the prescribed wind loads. A proper, continuous load path is an obvious design requirement, but experience has shown that it often is overlooked and that significant damage and collapse can result. The basis for this design requirement is two-fold:

1. To ensure that the design has fully identified the seismic-force-resisting system and its appropriate design level and
2. To ensure that the design basis is fully identified for the purpose of future modifications or changes in the structure.

Detailed requirements for analyzing and designing this load path are given in the appropriate design and materials chapters.

C11.1.2 Scope. The scope statement establishes in general terms the applicability of ASCE/SEI 7-05. Certain structures are exempt for the following reasons:

Exemption 1 – Detached one- and two-family dwellings in Seismic Design Categories A, B, and C, along with those located where $S_s < 0.4g$, are exempt because they represent low seismic risks.

Exemption 2 – Structures constructed using the conventional light-frame construction requirements in Section 12.5 are deemed capable of resisting the anticipated seismic forces. While specific elements of conventional light-frame construction may be calculated to be overstressed, typically there is a great deal of redundancy and uncounted resistance in such structures. Detached one- and two-story wood-frame dwellings generally have performed well even in regions of higher seismicity. Section 12.5 adequately provides the level of safety required for such dwellings without imposing any additional requirements.

Exemption 3 – Agricultural storage structures generally are exempt from most code requirements because of the exceptionally low risk to human life involved.

Exemption 4 – Bridges, transmission towers, nuclear reactors, and other structures with special configuration and uses are not covered. The regulations for buildings and building-like structures presented in this document do not adequately address the design and performance of such special structures.

ASCE/SEI 7-05 is not retroactive and usually applies to existing structures only when there is an addition, change of use, or alteration. Minimum acceptable seismic resistance of existing buildings is a policy issue normally set by the authority having jurisdiction. Appendix 11B of the standard contains rules of application for basic conditions. ASCE/SEI 31, *Seismic Evaluation of Buildings*, and ASCE/SEI 41, *Seismic Rehabilitation of Existing Buildings*, provide technical guidance but do not contain policy recommendations. A chapter in the *International Building Code (IBC)* applies to alteration, repair, addition, and change of occupancy of existing buildings, and the International Code Council maintains the *International Existing Building Code (IEBC)* and an associated commentary.

C11.1.4 Alternate Materials and Alternate Means and Methods of Construction. It is not possible for a design standard to provide criteria for the use of all possible materials and their combinations and methods of construction, either existing or anticipated. While not citing specific materials or methods of construction currently available that require approval, this section serves to emphasize that the evaluation and approval of alternate materials and methods require a recognized and accepted approval system. The requirements for materials and methods of construction contained within the document represent the judgment of the best use of the materials and methods based on well-established expertise and historical seismic performance. It is important that any replacement or substitute be evaluated with an understanding of all the ramifications of performance, strength, and durability implied by the standard.

It also is recognized that until needed standards and agencies are created, authorities having jurisdiction need to operate on the basis of the best evidence available to substantiate any application for alternates. If accepted standards are lacking, it is strongly recommended that applications be supported by extensive reliable data obtained from tests simulating, as closely as is practically feasible, the actual load and deformation conditions to which the material is expected to be subjected during the service life of the structure. These conditions, when applicable, should include several cycles of full reversals of loads and deformations in the inelastic range.

C11.4 SEISMIC GROUND MOTION VALUES¹

The approach adopted in Section 11.4 is intended to provide for a uniform margin against collapse at the design ground motion. In order to accomplish this objective, ground motion hazards are defined in terms of maximum considered earthquake (MCE) ground motions, which are based on a set of rules that depend on the seismic hazard of a region. Design ground motions are based on a lower bound estimate of the margin against collapse inherent in structures designed to the seismic provisions in the standard. This lower bound was judged, based on experience, to correspond to a factor of about 1.5 in ground motion. Consequently, the design earthquake ground motion was selected at a ground shaking level that is 1/1.5 (or 2/3) of the MCE ground motion.

For most regions of the nation, the MCE ground motion is defined with a uniform probability of exceedance of 2 percent in 50 years (return period of about 2500 years). While stronger shaking than this could occur, it was judged that it would be economically impractical to design for such very rare ground motions and that the selection of the 2 percent probability of exceedance in 50 years as the MCE ground motion would result in acceptable levels of seismic safety.

In regions of high seismicity, such as in many areas of California, the seismic hazard is typically controlled by large-magnitude events occurring on a limited number of well-defined fault systems. Probabilistic ground motions calculated at a 2 percent probability of exceedance in 50 years can be much larger than deterministic ground motions computed based on the characteristic magnitudes of earthquakes on these known active faults. These probabilistic motions are greater if these major active faults produce characteristic earthquakes every few hundred years. For these regions, it is considered more appropriate to determine MCE ground motions directly by deterministic methods based on the characteristic earthquakes of these defined faults. In order to provide an appropriate level of conservatism in the design process when the deterministic approach is used to calculate MCE ground motion, the median ground motion estimated for the characteristic event is multiplied by 1.5.

C11.4.1 Mapped Acceleration Parameters. In the general procedure, these motions are computed from mapped values of the spectral response acceleration at short periods, S_S , and at 1 second, S_I , for Class B sites. These S_S and S_I values may be obtained directly from Figures 22-1 through 22-14 (in Chapter 22). Development of these maps is explained in detail in Appendix A of the *Part 2 – Commentary* volume of the 2003 NEHRP Recommended Provisions. The 2003 S_S and S_I values also can be obtained from the U.S. Geological Survey (USGS) website: <http://earthquake.usgs.gov/designmaps>.

S_S is the mapped value of the 5-percent-damped MCE spectral response acceleration for short-period structures founded on Site Class B (firm rock) sites. The short-period acceleration has been determined at a period of 0.2 second because it was concluded that 0.2 second was reasonably representative of the shortest effective period of buildings and structures that are designed using the standard, considering the effects of soil compliance, foundation rocking, and other factors typically neglected in structural analysis.

Similarly, S_I is the mapped value of the 5-percent-damped MCE spectral response acceleration at a period of 1 second on Site Class B. The spectral response acceleration at periods other than 1 second typically can be derived from the acceleration at 1 second. Consequently, for MCE ground shaking on Site Class B sites, these two response acceleration parameters, S_S and S_I , are sufficient to define an entire response spectrum for the period range of importance for most buildings and structures.

C11.4.3 and C11.4.4 Site Coefficients and Adjusted Acceleration Parameters. Using the general procedure to obtain acceleration response parameters that are appropriate for sites with a classification other than Site Class B, the S_S and S_I values must be modified as indicated in Section 11.4.3. This modification is performed using two coefficients, F_a and F_v , that respectively scale the S_S and S_I values determined for Site Class B to values appropriate for other site classes. The MCE spectral response accelerations adjusted for site class are designated S_{MS} and S_{MI} , respectively, for short-period and 1-second-period response. As described above, structural design in ASCE/SEI 7-05 is performed for earthquake demands that are 2/3 of the MCE response spectra. As set forth in Section 11.4.4, two additional parameters, S_{DS} and S_{DI} , are used to define the acceleration response spectrum for this design level event. These parameters are 2/3 of the respective S_{MS} and S_{MI} values and define a design response spectrum for sites of any characteristics and for natural periods of vibration less than the transition period, T_L . Values of S_{MS} , S_{MI} , S_{DS} , and S_{DI} can also be obtained from the USGS website cited above.

The site coefficients, F_a and F_v , presented respectively in Tables 11.4-1 and 11.4-2 for the various site classes are based on the results of empirical analyses of strong-motion data and analytical studies of site response.

The amount of ground-motion amplification by a soil deposit relative to bedrock depends on the wave-propagation characteristics of the soil, which can be estimated from measurements or inferences of shear-wave velocity and in turn the

¹ Note that this section focuses on the methods and design procedures of ASCE/SEI 7-05 and the 2003 edition of the *Provisions*; commentary on the new risk-targeted maps and design procedures is presented in Part 1 of this volume following the modifications to ASCE 7 Section 11.4 and Chapter 22.

shear modulus for the materials as a function of the level of shaking. In general, softer soils with lower shear-wave velocities exhibit greater amplifications than stiffer soils with higher shear-wave velocities. Increased levels of ground shaking result in increased soil stress-strain nonlinearity and increased soil damping which, in general, reduces the amplification, especially for shorter periods. Furthermore, for soil deposits of sufficient thickness, soil amplification is generally greater at longer periods than at shorter periods.

An extensive discussion of the development of the F_a and F_v site coefficients is presented by Dobry, et al. (2000). Since the development of these coefficients and the development of a community consensus regarding their values in 1992, earthquake events have provided additional strong-motion data from which to infer site amplifications. Analyses conducted on the basis of these more recent data are reported by a number of researchers including Crouse and McGuire (1996), Dobry et al. (1999), Silva et al. (2000), Joyner and Boore (2000), Field (2000), Steidl (2000), Rodriguez-Marek et al. (2001), Borchardt (2002), and Stewart et al. (2003). Although the results of these studies vary, the site amplification factors are generally consistent with those in Tables 11.4-1 and 11.4-2.

C11.4.5 Design Response Spectrum. The design response spectrum (Figure 11.4-1) consists of several segments. The constant-acceleration segment covers the period band from T_o to T_s ; response accelerations in this band are constant and equal to S_{DS} . The constant-velocity segment covers the period band from T_s to T_L , and the response accelerations in this band are proportional to $1/T$ with the response acceleration at 1-sec period equal to S_{DI} . The long-period portion of the design response spectrum is defined on the basis of the parameter, T_L , the period that marks the transition from the constant-velocity segment to the constant-displacement segment of the design response spectrum. Response accelerations in the constant-displacement segment, where $T \geq T_L$, are proportional to $1/T^2$. Values of T_L are provided on maps in Figures 22-15 through 22-20.

The T_L maps were prepared following a two-step procedure. First, a correlation between earthquake magnitude and T_L was established. Then, the modal magnitude from deaggregation of the ground-motion seismic hazard at a 2-second period (1-second period for Hawaii) was mapped. Details of the procedure and the rationale for it are found in Crouse et al. (2006).

C11.4.7 Site-Specific Ground Motion Procedures. The objective of a site-specific ground-motion analysis is to determine ground motions for local seismic and site conditions with higher confidence than is possible using the general procedure of Sections 11.4.

Near-source effects on horizontal response spectra for periods of vibration greater than approximately 0.5 second include directivity, which increases ground motions for fault rupture propagating toward the site, and directionality, which increases ground motions normal (perpendicular) to the strike of the fault. These effects are discussed in Somerville et al. (1997) and Abrahamson (2000).

C11.5 IMPORTANCE FACTOR AND OCCUPANCY CATEGORY

Large earthquakes are rare events that will include severe ground motions. Such events are expected to result in damage to structures even if they were designed and built in accordance with the minimum requirements of the standard. The consequence of structural damage or failure is not the same for the various types of structures located within a given community. Serious damage to certain classes of structures, such as critical facilities (e.g., hospitals), will disproportionately affect a community. The fundamental purpose of this section and subsequent requirements that depend on this section is to improve the ability of a community to recover from a damaging earthquake by tailoring the seismic protection requirements to the relative importance of that structure. That purpose is achieved by requiring better performance of those structures that:

1. Are necessary to response and recovery efforts immediately following an earthquake,
2. Present the potential for catastrophic loss in the event of an earthquake, or
3. House a very large number of occupants or occupants less able to care for themselves than the average.

The first basis for seismic design in the standard is that structures will have a suitably low likelihood of collapse in the very rare event defined as the maximum considered earthquake (MCE) ground motion. A second basis is that life threatening damage, primarily from failure of nonstructural elements in and on structures, will be unlikely in an unusual but less rare earthquake ground motion, which is given as the design earthquake ground motion (defined as two-thirds of the MCE). Given the occurrence of ground motion equivalent to the MCE, a population of structures built to meet these design objectives will probably still experience substantial damage in many structures, rendering these structures unfit for occupancy or use. Experience in past earthquakes around the world has demonstrated that there will be an immediate need to treat injured people, to extinguish fires and prevent conflagration, to rescue people from severely damaged or collapsed structures, and to provide sustenance to a population deprived of its normal means. Experience also has shown that these needs are best met when structures essential to response and recovery activities remain functional.

The standard addresses these objectives by requiring that each structure be assigned to one of the four occupancy categories presented in Chapter 1 and by assigning an importance factor to the structure based upon that occupancy category. (The two lowest categories, Ordinary and Low Hazard, are combined for all purposes within the seismic provisions). The occupancy category is then used as one of two components in determining the Seismic Design Category (see Section C11.6) and is a primary factor in setting drift limits for building structures under the design earthquake ground motion (see Section C12.12).

Figure C11.5-1 shows the combined intent of these requirements for design. The vertical scale is the likelihood of the ground motion with the MCE being the rarest considered. The horizontal scale is the level of performance of the structure and attached nonstructural components from collapse prevention at the low end to operational at the high end. (These performance levels are discussed further at other locations in the commentary.) The basic objective of collapse prevention at the MCE for ordinary structures (Occupancy Category II) is shown at the lower right by the solid triangle; protection from life-threatening damage at the design ground motion (defined by the standard as two-thirds of the MCE) is shown by the open triangle. The performance implied for higher occupancy categories is shown by square and circles. The performance anticipated for less severe ground motion is shown by dotted symbols. The three (net) classes and the numerical values assigned are far too coarse to assure the portrayed outcome for all structures, but it is judged to be adequate for the purpose given present limitations of knowledge and tools.

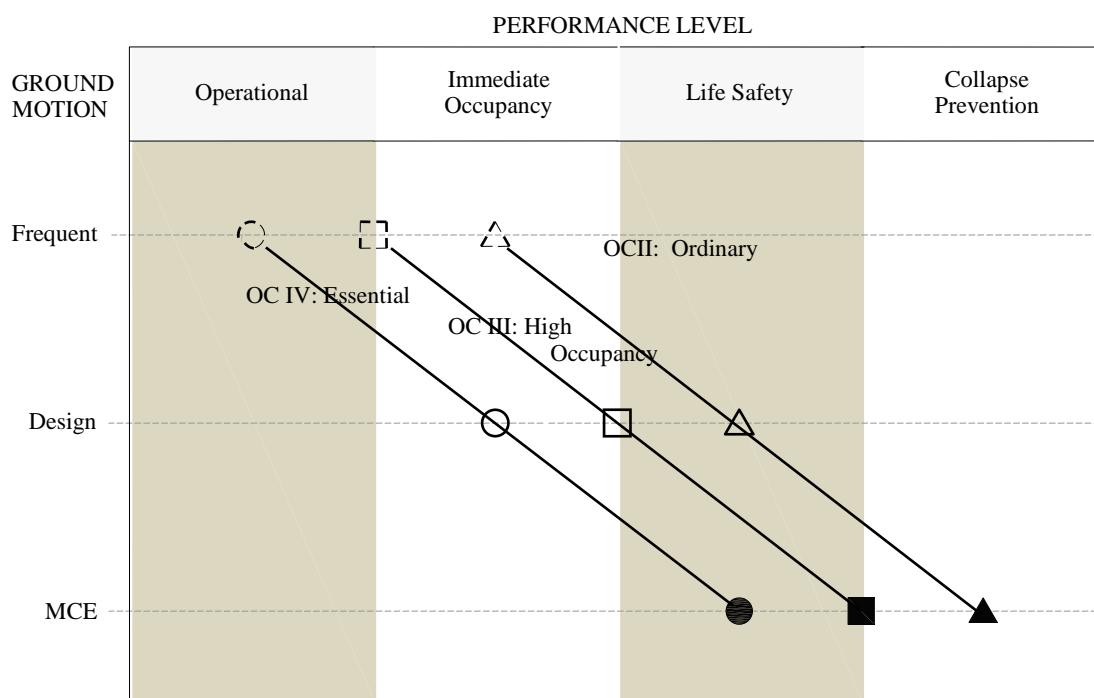

Figure C11.5-1 Expected performance as related to occupancy category (OC) and level of ground motion.

C11.5.1 Importance Factor. The importance factor is used throughout the standard in quantitative criteria for strength. In most of those quantitative criteria, the importance factor is shown as a divisor on the factor R or R_p in order to send a message to designers that the objective is to reduce damage for important structures in addition to preventing collapse in larger ground motions. The R and R_p factors adjust the computed linear elastic response to a value appropriate for design; in many structures, the largest component of that adjustment is ductility (the ability of the structure to undergo repeated cycles of inelastic strain in opposing directions). Inelastic strain damages a structure so, for a given strength demand, reducing the effective R factor (by means of the importance factor) increases the required yield strength, thus reducing ductility demand and related damage.

C11.5.2 Protected Access for Category IV Structures. Those structures considered essential facilities for response and recovery efforts must be accessible to carry out their purpose. For example, if the collapse of a simple canopy at a hospital could block ambulances from the emergency room admittance area, the canopy must meet the same structural standard as the hospital. This requirement must be considered in the siting of essential facilities in densely built urban areas.

C11.6 SEISMIC DESIGN CATEGORIES

Seismic design categories (SDCs) provide a means to step progressively from simple, easily performed design and construction procedures and minimums to more sophisticated, detailed, and costly requirements as both the level of seismic hazard and the consequence of failure escalate. The SDCs are used to trigger requirements that are not scalable; such requirements are either on or off. For example, the basic amplitude of ground motion for design is scalable – the quantity simply increases in a continuous fashion as one moves from a low hazard area to a high hazard area. However, a requirement to avoid weak stories is not particularly scalable. Requirements such as this create step functions. There are many such requirements in the standard, and the SDCs are used systematically to group these step functions. (Further examples include whether seismic anchorage of nonstructural items is required or not, whether particular inspections will be required or not, and height limits applied to various structural systems.)

In this regard, SDCs perform one of the functions of the seismic zones used in earlier U.S. building codes and still in use throughout much of the world. However, SDCs also are dependent on a building's occupancy and, therefore, its desired performance. Further, unlike the traditional implementation of seismic zones, the ground motions used to define the SDCs include the effects of individual site conditions on probable ground-shaking intensity.

In developing the ground-shaking limits for the various Seismic Design Categories and the design requirements for each, the equivalent modified Mercalli intensity (MMI) of various shaking spectra were considered. There are now various correlations of the qualitative MMI with quantitative characterizations of ground. The reader is encouraged to consult any of a great many sources that describe the MMIs. The following list is a very coarse generalization:

MMI V	No real damage
MMI VI	Light nonstructural damage
MMI VII	Hazardous nonstructural damage
MMI VIII	Hazardous damage to susceptible structures
MMI IX	Hazardous damage to robust structures

When the current design philosophy was adopted (the 1997 edition of the *NEHRP Recommended Provisions*, FEMA 302, and *Commentary*, FEMA 303), the upper limit for SDC A was set at roughly one-half of the lower threshold for MMI VII and the lower limit for SDC D was set at roughly the lower threshold for MMI VIII. However, the lower limit for SDC D was more consciously established by equating that design value (two-thirds of the MCE) to one-half of what had been the maximum design value in building codes over the period of 1975 to 1995. As more correlations between MMI and numerical representations of ground motion have been created, it is reasonable to make the following correlation between the MMI at MCE ground motion and the Seismic Design Category (all this discussion is for ordinary occupancies):

MMI V	SDC A
MMI VI	SDC B
MMI VII	SDC C
MMI VIII	SDC D
MMI IX	SDC E

An important change was made to the determination of SDC when the current design philosophy was adopted. Earlier editions of the *Provisions* utilized the peak velocity-related acceleration, A_v , to determine a building's Seismic Performance Category. However, this coefficient does not adequately represent the damage potential of earthquakes on sites with soil conditions other than rock. Consequently, the 1997 *Provisions* adopted the use of response spectral acceleration parameters S_{DS} and S_{DI} , which include site soil effects for this purpose.

Except for the lowest level of hazard (SDC A), the SDC also depends on the occupancy categories. For a given level of ground motion, the SDC is one category higher for Occupancy Category IV structures than for lower-risk structures. This has the effect of increasing the confidence that the design and construction requirements will deliver the intended performance in the extreme event.

Note that the tables in the standard are at the design level, defined as two-thirds of the MCE level. Also recall that the MMIs are qualitative by their nature and that the above correlation will be more or less valid depending on which numerical correlation for MMI is used. The numerical correlations for MMI roughly double with each step so correlation between design earthquake ground motion and MMI is not as simple or convenient.

In sum, at the MCE level, SDC A structures should not see motions that are normally destructive to structural systems, whereas the MCE level motions for SDC D structures can destroy vulnerable structures. The grouping of step function

requirements by SDC is such that there are a few basic structural integrity requirements imposed at SDC A graduating to a suite of requirements at SDC D based upon observed performance in past earthquakes, analysis, and laboratory research.

The nature of ground motions within a few kilometers of a fault can be very different from more distant motions. For example, some near fault motions will have strong velocity pulses, associated with forward rupture directivity, that tend to be highly destructive to irregular structures even if they are well detailed. For ordinary occupancies, the boundary between SDCs D and E is set to define sites likely to be close enough to a fault that these unusual ground motions may be present. Note that this boundary is defined in terms of mapped bedrock outcrop motions affecting response at 1 second, not site adjusted values, in order to better discriminate between sites near and far from faults. Short-period response is not normally as affected as the longer period response. The additional design criteria imposed on structures in SDCs E and F specifically are intended to provide acceptable performance under these very intense near-fault ground motions.

For most buildings, the SDC is determined without consideration of the building's period. Structures are assigned to a SDC based on the more severe condition determined from 1-second acceleration and short-period acceleration. This is done for several reasons. Perhaps the most important of these is that it is often difficult to estimate precisely the period of a structure using default procedures contained in the standard. Consider, for example, the case of rigid wall/flexible diaphragm buildings including low-rise reinforced masonry and concrete tilt-up buildings with either untopped metal deck or wood diaphragms. The formula in the standard for determining the period of vibration of such buildings is based solely on the height of the structure and the length of wall present. These formulas typically indicate very short periods for such structures, often on the order of 0.2 second or less. However, the actual dynamic behavior of these buildings often is dominated by the flexibility of the diaphragm – a factor neglected by the approximate period formula. Large buildings of this type can have actual periods on the order of 1 second or more. In order to avoid misclassifying a building's SDC by inaccurately estimating the structural period, the standard generally requires that the more severe SDC determined on the basis of short- and long-period shaking be used.

Another reason for this requirement is a desire to simplify building regulation by requiring all buildings on a given soil profile in a particular region to be assigned to the same SDC regardless of the structural type. This has the advantage of permitting uniform regulation of structural system selection, inspection and testing requirements, seismic design requirements for nonstructural components, and similar aspects of the design process regulated on the basis of SDC, within a community.

Notwithstanding the above, it is recognized that classification of a building as SDC C instead of B or D can have significant impact on the cost of construction. Therefore, the 2005 edition of the standard includes an exception permitting the classification of buildings that can reliably be classified as having short structural periods on the basis of short-period shaking alone.

Local or regional jurisdictions enforcing building regulations may desire to consider the effect of the maps, typical soil conditions, and Seismic Design Categories on the practices in their jurisdictional areas. For reasons of uniformity of practice or reduction of potential errors, adopting ordinances could stipulate particular values of ground motion, particular site classes, or particular Seismic Design Categories for all or part of the area of their jurisdiction. For example:

1. An area with a historical practice of high seismic zone detailing might mandate a minimum SDC of D regardless of ground motion or site class.
2. A jurisdiction with low variation in ground motion across the area might stipulate particular values of ground motion rather than requiring use of the maps.
3. An area with unusual soils might require use of a particular Site Class unless a geotechnical investigation proves a better Site Class.

C11.7 DESIGN REQUIREMENTS FOR SEISMIC DESIGN CATEGORY A

Seismic Design Category A is assigned when the MCE ground motions are well known to be below those normally associated with hazardous damage. Damaging earthquakes are not unknown or impossible in such regions, however, and ground motions close to such events may be large enough to produce serious damage. Providing a minimum level of resistance reduces both the radius over which the ground motion exceeds structural capacities and resulting damage in such rare events. There are reasons beyond seismic risk for minimum levels of structural integrity.

The requirements for SDC A are all minimum strengths for structural elements stated as forces at the level appropriate for direct use in the strength design load combinations. The two fundamental requirements are a minimum strength for a structural system to resist lateral forces and a minimum strength for connections of structural members.

For many buildings the wind force will control the strength of the lateral-force-resisting system but, for low-rise buildings of heavy construction with large plan aspect ratio, the minimum lateral force specified here may control. Note that the requirement is for strength and not for toughness, energy dissipation capacity, or some measure of ductility. The force level is not tied to any postulated seismic ground motion. The boundary between SDCs A and B is based on a spectral response acceleration of 25 percent of gravity (MCE level) for short-period structures; clearly the 1 percent acceleration level (Equation 11.7-1) is far smaller. For ground motions below the A/B boundary, the spectral displacements generally are on the order of a few inches or less depending on period. Experience has shown that even a minimal strength is beneficial in providing resistance to small ground motions, and it is an easy provision to implement in design. The low probability of motions greater than the MCE is a factor in taking the simple approach without requiring details that would produce a ductile response. Another factor is that larger design forces are specified for connections between main elements of the lateral force load path.

The minimum connection force is specified in three ways: a general minimum horizontal capacity for all connections; a special minimum for horizontal restraint of beams and trusses in line, which also includes the live load on the member; and a special minimum for horizontal restraint of concrete and masonry walls perpendicular to their plane. The 5 percent coefficient used for the first two is a simple and convenient value that provides some margin over the minimum strength of the system as a whole. The value for anchorage of concrete and masonry walls is simply scaled upward from the value of 200 pounds per linear foot traditionally used in past building codes for allowable stress design.

C11.8 GEOLOGIC HAZARDS AND GEOTECHNICAL INVESTIGATION

In addition to this commentary, Part 3 of the 2009 *NEHRP Recommend Provisions* includes additional and more detailed discussion and guidance on evaluation of geologic hazards and determination of seismic lateral pressures.

C11.8.1 Site Limitation for Seismic Design Categories E and F. Because of the difficulty of designing a structure for the direct shearing displacement of fault rupture and the relatively high seismic activity of SDCs E and F, locating a structure on an active fault having the potential to cause rupture of the ground surface at the structure is prohibited.

C11.8.3 Additional Geotechnical Investigation Report Requirements for Seismic Design Categories D through F. The dynamic lateral earth pressure on basement and retaining walls during earthquake ground shaking is considered to be an earthquake load, *E*, for use in design load combinations. This dynamic earth pressure is superimposed on the pre-existing static lateral earth pressure during ground shaking. The pre-existing static lateral earth pressure is considered to be an *H* load.

Liquefaction potential should be evaluated for design earthquake ground motions consistent with peak ground accelerations of $S_{DS}/2.5$. The occurrence and consequences of geologic hazards for MCE ground motions also should be considered when evaluating structural stability and other pertinent performance criteria.

REFERENCES

- Abrahamson, N.A. 2000. "Effects of Rupture Directivity on Probabilistic Seismic Hazard Analysis" in *Proceedings of the 6th International Conference on Seismic Zonation*, Palm Springs, California.
- Borcherdt, R. D. 2002. "Empirical Evidence for Site Coefficients in Building-code Provisions," *Earthquake Spectra*, 18(2):189-217.
- Crouse, C. B., and J. W. McGuire. 1996. "Site Response Studies for Purposes of Revising NEHRP Seismic Provisions," *Earthquake Spectra*, 12(3).
- Crouse, C. B., E. V. Leyendecker, P. G. Somerville, M. Power, and W. J. Silva. 2006. "Development of Seismic Ground-Motion Criteria for the ASCE/SEI 7 Standard," Paper 533 in *Proceedings 8th U.S. National Conference on Earthquake Engineering*, April 18-22, 2006, San Francisco, California.
- Dobry, R., R. Ramos, and M. S. Power. 1999. *Site Factors and Site Categories in Seismic Codes*, Technical Report MCEER-99-0010. Multidisciplinary Center for Earthquake Engineering Research.
- Dobry, R., R. Borcherdt, C. B. Crouse, I. M. Idriss, W. B. Joyner, G. R. Martin, M. S. Power, E. E. Rinne, and R. B. Seed. 2000. "New Site Coefficients and Site Classifications System Used in Recent Building Seismic Code Provisions," *Earthquake Spectra*, 16(1):41-67.
- Field, E. H. 2000. "A Modified Ground Motion Attenuation Relationship for Southern California that Accounts for Detailed Site Classification and a Basin Depth Effect," *Bulletin of the Seismological Society of America*, 90:S209-S221.
- Joyner, W. B., and D. M. Boore. 2000. "Recent Developments in Earthquake Ground Motion Estimation in *Proceeding of*

the 6th International Conference on Seismic Zonation, Palm Springs, California.

Rodriguez-Marek, A., J. D. Bray, and N. Abrahamson. 2001. "An Empirical Geotechnical Site Response Procedure," *Earthquake Spectra*, 17(1):65-87.

Silva, W., R. Darragh, N. Gregor, G. Martin, N. Abrahamson, and C. Kircher. 2000. *Reassessment of Site Coefficients and Near-fault Factors for Building Code Provisions*, Program Element II, Report 98-HQ-GR-1010 to the U.S. Geological Survey.

Somerville, P. G., N. F. Smith, R. W. Graves, and N. A. Abrahamson. 1997. "Modification of Empirical Strong Ground Motion Attenuation Relations to Include the Amplitude and Duration Effects of Rupture Directivity," *Seismological Research Letters*, 68:199-222.

Stewart, J. P., A. H. Liu, and Y. Choi. 2003. "Amplification Factors for Spectral Acceleration in Tectonically Active Regions," *Bulletin of the Seismological Society of America*, 93(1):332-352.

Steidl, J. H. 2000. "Site Response in Southern California for Probabilistic Seismic Hazard Analysis," *Bulletin of the Seismological Society of America*, 90:S149-S169.

COMMENTARY TO CHAPTER 12, SEISMIC DESIGN REQUIREMENTS FOR BUILDING STRUCTURES

C12.1 STRUCTURAL DESIGN BASIS

The performance expectations for structures designed in accordance with ASCE/SEI 7-05 are described in Sections C11.1 and C11.5. Structures designed in accordance with the standard are likely to have a low probability of collapse but suffer serious damage if subjected to the maximum considered earthquake (MCE) or stronger ground motion. The uncertainty in performance results from variability of both ground motion and structural characteristics.

Earthquakes load structures indirectly. As the ground displaces, a structure follows and vibrates. The vibration produces structural deformations with associated strains and stresses. Computation of dynamic response to earthquake ground shaking is complex. The basic methods of analysis in the standard employ the common simplification of a response spectrum. A response spectrum for a specific earthquake ground motion approximates the maximum value of response to that ground motion for simple structures without reflecting the total time history of response. The design response spectrum specified in Section 11.4 and used in the basic methods of analysis in Chapter 12 is a smoothed and normalized approximation for many different ground motions.

Although the seismic requirements of the standard are stated in terms of forces and loads, there are no external forces applied to the above-ground portion of a structure during an earthquake. The design forces are intended only as approximations to generate internal forces suitable for proportioning the strength of structural elements and for estimating the deformations (when multiplied by the deflection amplification factor, C_d) that would occur in the same structure in the event of design-level (not MCE) ground motion.

C12.1.1 Basic Requirements. Chapter 12 of the standard sets forth a set of coordinated requirements that must be used together. The basic steps in structural design for acceptable seismic resistance are as follows:

1. Select gravity- and seismic-force-resisting systems appropriate to the anticipated intensity of ground shaking. Section 12.2 sets forth limitations depending on the Seismic Design Category.
2. Lay out these systems to produce a continuous, regular, and redundant load path so that the structures act as integral units in responding to ground shaking. Section 12.3 addresses configuration and redundancy issues.
3. Analyze a mathematical model of the structure subjected to lateral seismic motions and gravity forces. Sections 12.6 and 12.7 set forth requirements for the method of analysis and for construction of the mathematical model.
4. Proportion members and connections to have adequate lateral and vertical strength and stiffness. Section 12.4 specifies how the effects of gravity and seismic loads are to be combined to establish required strengths, and Section 12.12 specifies deformation limits for buildings.

One- to three-story structures with shear wall or braced frame systems of simple configuration may be eligible for design under the simplified alternative contained in Section 12.14. Any other deviations from the requirements of Chapter 12 are subject to approval and must be rigorously consistent as specified in Section 11.1.4.

The baseline seismic forces for proportioning structural elements (individual members, connections, and supports) are static horizontal forces derived from a linear elastic response spectrum procedure. A basic requirement is that horizontal motion can come from any direction, with detailed requirements being provided in Section 12.5. For most structures, the effect of vertical ground motions is not analyzed specifically; it is included in an approximate fashion by adjusting the load factors for dead load up and down, as described in Section 12.4. Certain conditions requiring more detailed analysis of vertical response are defined in Chapters 13 and 15 for nonstructural components and nonbuilding structures, respectively.

Higher levels of seismic analysis are permitted (and encouraged) for any structure and are required for some structures (see Section 12.6), but lower limits based on the equivalent lateral force procedures apply. The basic procedure uses response spectra that are representative of, but substantially reduced from, the anticipated ground motions. As a result, at the MCE level of ground shaking, structural elements are expected to yield, buckle, or otherwise behave inelastically.

This approach has substantial historical precedent. In past earthquakes, structures with appropriately ductile, regular, continuous systems designed for reduced forces have performed acceptably. In the standard, such design forces are computed by dividing the forces that would be generated in a structure behaving linearly when subjected to the design ground motion by the response modification coefficient, R , and the design ground motion is taken as two-thirds of the MCE ground motion.

The elastic deformations calculated under these reduced design forces are multiplied by the deflection amplification factor, C_d , to estimate the deformations likely to result from the design ground motion. As set forth in Sections 12.12 and 13, the amplified deformations are used to assess story drifts and to determine seismic demands on elements of the structure that are not part of the seismic-force-resisting system and on nonstructural components within structures. Where C_d is substantially less than R , the system is considered to have damping greater than the nominal 5 percent of critical damping.

The seismic-force-resisting system is expected to reach significant yield for forces in excess of the design forces. Significant yield is the point where complete plastification of the most critical region of the structure (e.g., formation of a first plastic hinge in the structure) occurs, not the point where first yield occurs in any member. Figure C12.1-1 shows the lateral force versus deformation relation for a typical structure. Significant yield is shown as the lowest yield hinge on the force-deformation diagram. With increased lateral loading, additional plastic hinges form and the resistance increases (following the solid curve) until a maximum is reached. The maximum resistance developed along the curve is substantially higher than that at first significant yield, and the margin is referred to as the overstrength capacity.

The provisions of the standard contemplate a seismic-force-resisting system with redundant characteristics wherein significant structural overstrength above the level of significant yield can be obtained by plastification at other points in the structure prior to the formation of a complete mechanism. The overstrength obtained by this continued inelastic action provides the reserve strength necessary for the structure to resist the extreme motions of the actual seismic forces that may be generated by the design ground motion.

The structural overstrength described above results from the development of sequential plastic hinging in a properly designed, redundant structure. Several other sources will further increase structural overstrength. First, material overstrength (i.e., actual material strengths higher than the nominal material strengths specified in the design) may increase the structural overstrength significantly. For example, a recent survey shows that the mean yield strength of A36 steel is about 30 to 40 percent higher than the minimum specified strength used in design calculations. Second, member design strengths usually incorporate a strength reduction (or resistance) factor, Φ , to produce a low probability of failure under design loading. Third, designers themselves introduce additional overstrength by selecting sections or specifying reinforcing patterns that exceed those required by the computations. Similar situations occur where prescriptive minimums of the standard, or of the design standards referenced from it, control the design. Finally, the design of many flexible structural systems (e.g., moment resisting frames) often is controlled by the drift rather than strength limitations of the standard with sections selected to control lateral deformations rather than to provide the specified strength.

The result is that structures typically have a much higher lateral resistance than that specified as a minimum by the standard, and first significant yielding of structures may occur at lateral load levels that are 30 to 100 percent higher than the prescribed design seismic forces. If provided with adequate ductile detailing, redundancy and regularity, full yielding of structures may occur at load levels that are two to four times the prescribed design force levels.

Most structural systems have some components or limit states that cannot provide reliable inelastic response or energy dissipation. Such components or limit states must be designed considering that the actual forces in the structure will be larger than those at first significant yield. The standard specifies an overstrength factor, Ω_0 , to amplify the prescribed forces for use in design of such components or limit states. This specified overstrength factor is neither an upper nor a lower bound; it is simply an approximation specified to provide a nominal degree of protection against undesirable behavior.

Figure C12.1-1 illustrates the significance of design parameters contained in the standard including the response modification coefficient, R ; the deflection amplification factor, C_d ; and the system overstrength factor, Ω_0 . These design values, provided in Table 12.2-1, as well as the criteria for story drift and P -delta effects, have been established considering the characteristics of typical properly designed structures. The actual structural overstrength, Ω , often will be less than the tabulated factor, Ω_0 . This means that the required ductility, R_d , usually will exceed R/Ω_0 . If excessive "optimization" of a structural design is performed with lateral resistance provided by only a few elements, the successive yield hinge behavior depicted in Figure C12.1-1 will not be able to form, the actual overstrength (Ω) will be small, and use of the design parameters in the standard may not provide the intended seismic performance.

The response modification coefficient, R , represents the ratio of the forces that would develop under the specified ground motion if the structure had entirely linear-elastic response to the prescribed design forces (see Figure C12.1-1). The structure must be designed so that the level of significant yield exceeds the prescribed design force. The ratio R , expressed as $R = V_E/V_S$, is always larger than 1.0; thus, all structures are designed for forces smaller than those the design ground motion would produce in a structure with completely linear-elastic response. This reduction is possible for a number of reasons. As the structure begins to yield and deform inelastically, the effective period of response of the structure lengthens which, for most structures, results in a reduction in strength demand. Furthermore, the inelastic action results in a significant amount of energy dissipation (hysteretic damping) in addition to other sources of damping present below significant yield. The combined effect, which is also known as the ductility reduction, explains why a properly designed structure with a fully

yielded strength (V_y in Figure C12.1-1) that is significantly lower than the elastic seismic force demand (V_E in Figure C12.1-1) can be capable of providing satisfactory performance under the design ground motion excitations.

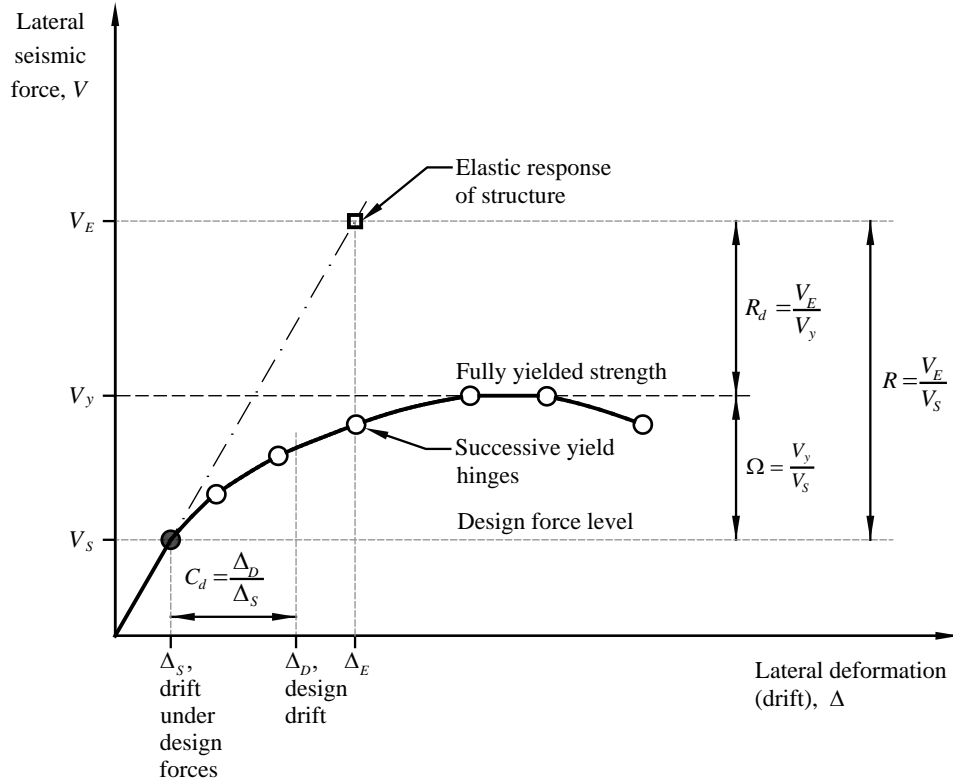

Figure C12.1-1 Inelastic force-deformation curve.

The energy dissipation resulting from hysteretic behavior can be measured as the area enclosed by the force-deformation curve of the structure as it experiences several cycles of excitation. Some structures have far more energy dissipation capacity than others. The extent of energy dissipation capacity available depends largely on the amount of stiffness and strength degradation the structure undergoes as it experiences repeated cycles of inelastic deformation. Figure C12.1-2 shows representative load deformation curves for two simple substructures such as a beam-column assembly in a frame. Hysteretic curve (a) in the figure is representative of the behavior of substructures that have been detailed for ductile behavior. The substructure can maintain nearly all of its strength and stiffness over several large cycles of inelastic deformation. The resulting force-deformation “loops” are quite wide and open, resulting in a large amount of energy dissipation. Hysteretic curve (b) represents the behavior of a substructure that has not been detailed for ductile behavior. It loses stiffness rapidly under inelastic deformation, and the resulting hysteretic loops are quite pinched. Such a substructure has much less energy dissipation than that for the substructure (a) but has a greater change in response period. The structural response is determined by a combination of energy dissipation and period modification.

The R values in the standard are based largely on engineering judgment of the performance of the various materials and systems in past earthquakes. The R factor for a specific project should be chosen and used with care. For example, lower values should be used for structures possessing a low degree of redundancy wherein all the plastic hinges required for the formation of a mechanism may be formed essentially simultaneously and at a force level close to the specified design strength. This situation can result in considerably more detrimental P -delta effects. Since it is difficult for individual designers to judge the extent to which R factors should be adjusted based on the inherent redundancy of their designs, Section 12.3.4 provides a coefficient, ρ , that is calculated based on the removal of individual seismic-force-resisting elements.

C12.1.2 Member Design, Connection Design, and Deformation Limit. Given that key elements of the seismic-force-resisting system will likely yield in response to ground motions as discussed in Section C12.1.1, it might be expected that structural connections would be required to develop the strength of connected members. Although that is a logical procedure, it is not a general requirement. The actual requirement varies by system and generally is specified in the standards for design of the various structural materials cited by reference in Section 14. Good seismic design requires careful consideration of this issue.

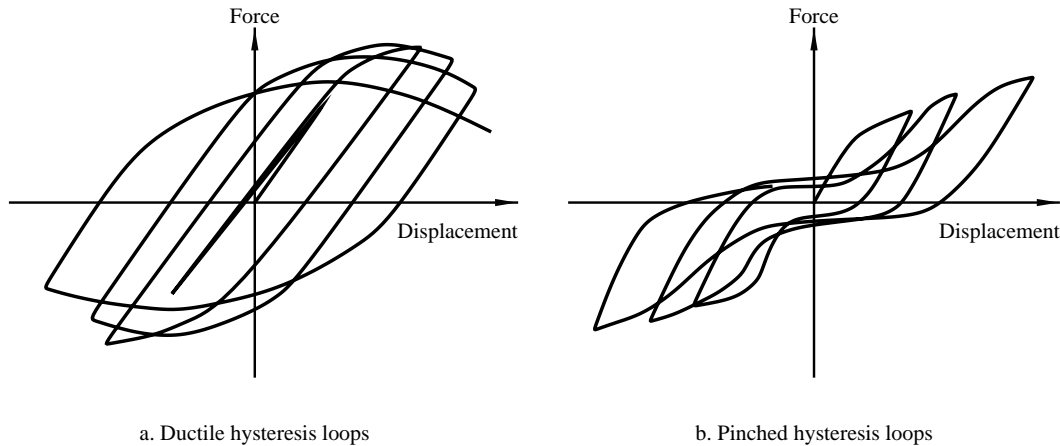

Figure C12.1-2 Typical hysteretic curves.

C12.1.3 Continuous Load Path and Interconnection. In effect, Section 12.1.3 calls for the seismic design to be complete and in accordance with the principles of structural mechanics. The loads must be transferred rationally from their point of origin to the final point of resistance. This should be obvious, but it often is overlooked by those inexperienced in earthquake engineering. Design consideration should be given to potentially adverse effects where there is a lack of redundancy. Given the many unknowns and uncertainties in the magnitude and characteristics of earthquake loading, in the materials and systems of construction for resisting earthquake loadings and in the methods of analysis, good earthquake engineering practice has been to provide as much redundancy as possible in the seismic-force-resisting system of buildings. Redundancy plays an important role in determining the ability of the building to resist earthquake forces. In a structural system without redundant components, every component must remain operative to preserve the integrity of the building structure. On the other hand, in a highly redundant system, one or more redundant components may fail and still leave a structural system that retains its integrity and can continue to resist lateral forces, albeit with diminished effectiveness.

While a redundancy requirement is included in Section 12.3.4, overall system redundancy can be improved by making all joints of the vertical load-carrying frame moment resisting and incorporating them into the seismic-force-resisting system. These multiple points of resistance can prevent a catastrophic collapse due to distress or failure of a member or joint. (The overstrength characteristics of this type of frame are discussed in Section C12.1.1.) The designer should be particularly aware of the proper selection of R when using only one- or two-bay rigid frames in one direction for resisting seismic loads. A single, one-bay frame or a pair of such frames provides little redundancy so the designer may wish to consider a reduced R to account for a lack of redundancy if the calculated redundancy is considered to be too low. As more one-bay frames are added to the system, however, overall system redundancy increases. The increase in redundancy is a function of frame placement and total number of frames.

The minimum connection forces are not intended to be applied simultaneously to the entire seismic-force-resisting system.

C12.1.4 Connection to Supports. The requirement is the same as given in Section 11.7.4 for Seismic Design Category A. See Section C11.7.

C12.1.5 Foundation Design. Most foundation design criteria are still stated in terms of allowable stresses, and the forces computed in the standard are all based on the strength level of response. When developing strength-based criteria for foundations, all the factors cited in Section 12.1.5 require careful consideration. Section C12.13 provides specific guidance.

C12.1.6 Material Design and Detailing Requirements. The design limit state for resistance to an earthquake is unlike that for any other load within the scope of the standard. The earthquake limit state is based on overall system performance, not member performance, where repeated cycles of inelastic straining are accepted as an energy dissipating mechanism. Provisions that modify customary requirements for proportioning and detailing structural members and systems are provided to produce the desired performance.

C12.2 STRUCTURAL SYSTEM SELECTION

C12.2.1 Selection and Limitations. For purposes of these seismic analyses and design requirements, seismic-force-resisting systems are grouped into categories as shown in Table 12.2-1. These categories are subdivided further for various types of vertical elements used to resist seismic forces. In addition, the sections for detailing requirements are specified.

Specification of R factors requires considerable judgment based on knowledge of actual earthquake performance as well as research studies. The factors in Table 12.2-1 continue to be reviewed in light of recent research results. R values for the various systems were selected considering observed performance during past earthquakes, the toughness (ability to dissipate energy without serious degradation) of the system, and the amount of damping typically present in the system when it undergoes inelastic response. FEMA P-695, *Quantification of Building Seismic Performance Factors* (Applied Technology Council, 2009) has been developed with the purpose of establishing and documenting a methodology for quantifying building system performance and response parameters for use in seismic design. While the response modification coefficient (R factor) is a key parameter being addressed, related design parameters such as the system overstrength factor (Ω_0) and deflection amplification factor (C_d) also are addressed. Collectively, these terms are referred to as “Seismic Performance Factors” (SPFs). Future systems will likely derive their SPFs using this methodology and existing system SPFs also may be reviewed in light of this new procedure.

Building height limits have been specified in codes and standards for over 50 years. The structural system limitations and building height limits specified in Table 12.2-1 evolved from these initial limitations and were further modified by the collective expert judgment of the PUC and the ATC-3 project team (the forerunners of the PUC). They have continued to evolve over the past 30 years based on observations and testing, but the specific values are based on subjective judgment.

In a bearing wall system, major load-carrying columns are omitted and the walls carry a major portion of the gravity (dead and live) loads. The walls supply in-plane lateral stiffness and strength to resist wind and earthquake loads as well as other lateral loads. In some cases, vertical trusses are employed to augment lateral stiffness. In general, this system has comparably lower values of R than other systems due to the frequent lack of redundancy for support of vertical and horizontal loads.

In a building frame system, gravity loads are carried primarily by a frame supported on columns rather than by bearing walls. Some portions of the gravity load may be carried on bearing walls, but the amount carried should represent a relatively small percentage of the floor or roof area. Lateral resistance is provided by shear walls or braced frames. Light-framed walls with shear panels are intended for use only with wood and steel building frames. Although gravity-load-resisting systems are not required to provide lateral resistance, most of them do. To the extent that the gravity-load-resisting system provides additional lateral resistance, it will enhance the building’s seismic performance capability, so long as it is capable of resisting the resulting stresses and undergoing the associated deformations.

In a moment-resisting frame system, moment-resisting connections between the columns and beams provide lateral resistance. In Table 12.2-1, such frames are classified as ordinary, intermediate, or special. In high Seismic Design Categories, the anticipated ground motions are expected to produce large inelastic demands so special moment frames designed and detailed for ductile response in accordance with Chapter 14 are required. In low Seismic Design Categories, the inherent overstrength in typical structural designs is such that the anticipated inelastic demands are reduced somewhat, and less ductile systems may be employed safely. Since these less ductile ordinary framing systems do not possess as much toughness, lower R values are specified.

The R , Ω_0 , and C_d values for the composite systems in Table 12.2-1 are similar to those for comparable systems of structural steel and reinforced concrete. Use of the tabulated values is allowed only when the design and detailing requirements in Section 14.3 are followed.

In a dual system, a three-dimensional space frame made up of columns and beams provides primary support for gravity loads. Primary lateral resistance is supplied by shear walls or braced frames, and secondary lateral resistance is provided by a moment frame complying with the requirements of Chapter 14.

Where a beam-column frame or slab-column frame lacks special detailing, it cannot act as an effective backup to a shear wall subsystem so there are no dual systems with ordinary moment frames. Instead, Table 12.2-1 permits the use of a shear wall-frame interactive system with ordinary reinforced concrete moment frames and ordinary reinforced concrete shear walls. Use of this defined system, which requires compliance with Section 12.2.5.10, offers a significant advantage over a simple combination of the two constituent ordinary reinforced concrete systems. Where those systems are simply combined, Section 12.2.3.2 would require use of design parameters for an ordinary reinforced concrete moment frame.

In a cantilevered column system, stability of mass at the top is provided by one or more columns with base fixity acting as a single-degree-of-freedom system.

Cantilever column systems are essentially a special class of moment-resisting frame except that they do not possess the redundancy and overstrength that most moment-resisting frames derive from sequential formation of yield or plastic hinges. Where a typical moment-resisting frame must form multiple plastic hinges in members in order to develop a yield mechanism, a cantilever column system develops hinges only at the base of the columns to form a mechanism. As a result, their overstrength is limited to that provided by material overstrength and by design conservatism.

It is permitted to construct cantilever column structures using any of the systems that can be used to develop moment frames including ordinary, intermediate, and special steel and concrete detailing systems as well as timber frames. The system limitations for cantilever column systems reflect the type of moment frame detailing provided but with a height limit of 35 feet.

The R factor for cantilever column systems is derived from moment-resisting frame values where R is divided by Ω_0 but is not taken as less than 1 or greater than 3. This accounts for the lack of sequential yielding in such systems. C_d is taken as equal to R , recognizing that damping is quite low in these systems and inelastic displacement of these systems will not be less than the elastic displacement.

C12.2.2 Combinations of Framing Systems in Different Directions. Different systems can be utilized along each of the two orthogonal directions as long as the respective R , Ω_0 , and C_d values are used. Depending on the combination selected, it is possible that one of the two systems will limit the extent of the overall system with regard to use and height. The more restrictive of the limitation systems governs.

C12.2.3 Combinations of Framing Systems in the Same Direction.

C12.2.3.1 R , Ω_0 , and C_d Values for Vertical Combinations. The intent of the provision requiring use of the more stringent seismic design parameters (R , Ω_0 , and C_d) is to prevent mixed systems that could concentrate inelastic behavior in the lower stories. Exceptions to these requirements exist for conditions that do not affect the dynamic characteristics of the structure or that will not result in concentration of inelastic demand in critical areas.

For the past several decades, building codes have allowed two-stage static analysis for certain structures with a vertical combination of dynamically uncoupled systems. While this approach may be used for any structure that meets the requirements, it is most often used for the design of light-framed construction built on a rigid concrete base. The design process requires that the “flexible” upper structure and “rigid” lower structure be designed separately with the reactions from the upper portion amplified by the ratio of respective R/ρ values. This ratio, which must be taken as no less than 1, produces demands for the “rigid” lower portion that are commensurate with its inelastic capability.

C12.2.3.2 R , Ω_0 , and C_d Values for Horizontal Combinations. For nearly all conditions, the least value of R of different structural systems in the same direction must be used in design. This requirement reflects the expectation that the entire system will undergo the same deformation with its behavior controlled by the least ductile system. However, where the listed conditions are met, the R value for each independent line of resistance can be used. This exceptional condition is consistent with light-frame construction that utilizes the ground for parking with residential use above.

C12.2.4 Combination of Framing Detailing Requirements. This requirement is provided so that the higher R value system has the necessary ductile detailing throughout. The intent is that details common to both systems be designed to remain functional throughout the response in order to preserve the integrity of the seismic-force-resisting system.

C12.2.5 System Specific Requirements.

C12.2.5.1 Dual System. The moment frame of a dual system must be capable of resisting at least 25 percent of the design seismic forces; this percentage is based on judgment. The purpose of the 25 percent frame is to provide a secondary lateral system with higher degrees of redundancy and ductility in order to improve the ability of the building to support the service loads (or at least the effect of gravity loads) after strong earthquake shaking. The primary system (walls or bracing) acting together with the moment frame must be capable of resisting all of the design seismic forces. The following analyses are required for dual systems:

1. The moment frame and shear walls or braced frames must resist the design seismic forces considering fully the force and deformation interaction of the walls or braced frames and the moment frames as a single system. This analysis must be made in accordance with the principles of structural mechanics considering the relative rigidities of the elements and torsion in the system. Deformations imposed upon members of the moment frame by their interaction with the shear walls or braced frames must be considered in this analysis.
2. The moment frame must be designed with sufficient strength to resist at least 25 percent of the design seismic forces including torsional effects.

C12.2.5.2 Cantilever Column Systems. Cantilever column systems are singled out for special consideration because of their unique characteristics. These structures often have limited redundancy and overstrength and concentrate inelastic behavior at their bases. As a result, they have substantially less energy dissipation capacity than other systems. A number of apartment buildings incorporating this system experienced very severe damage and, in some cases, collapse in the 1994 Northridge earthquake. Because the ductility of columns having large axial stress is limited, cantilever column systems may not be used where column axial demands exceed 15 percent of their axial strength.

Elements providing restraint at the base of cantilever columns must be designed with overstrength so that the strength of the cantilever columns is developed.

C12.2.5.3 Inverted Pendulum-Type Structures. Inverted pendulum-type structures do not have unique entry in Table 12.2-1 since they can be formed from many structural systems. Inverted pendulum-type structures have more than half of their mass concentrated near the top (producing one degree of freedom in horizontal translation) and rotational compatibility of the mass with the column (producing vertical accelerations acting in opposite directions). Dynamic response amplifies this rotation; hence, the bending moment induced at the top of the column can exceed that computed using the procedures of Section 12.8. The requirement to design for a top moment that is one-half of the base moment calculated in accordance with Section 12.8 is based on analyses of inverted pendulums covering a wide range of practical conditions.

C12.2.5.4 Increased Building Height Limit for Steel Braced Frames and Special Reinforced Concrete Shear Walls. The first criterion for an increased building height limit precludes extreme torsional irregularity since premature failure of one of the single walls or frames could lead to excessive inelastic torsional response. The second criterion, which is similar to the redundancy requirements, is to limit the height of systems that are too strongly dependent on any single line of walls or braced frames. The inherent torsion resulting from the distance between the center of mass and center of stiffness must be included, but accidental torsional effects are neglected for ease of implementation.

C12.2.5.5 Special Moment Frames in Structures Assigned to Seismic Design Categories D through F. Special moment frames, either alone or as part of a dual system, are required to be used in Seismic Design Categories D through F where the building height exceeds 160 feet (or 240 feet for buildings that meet the provisions of Section 12.2.5.4) as indicated in Table 12.2-1. In shorter buildings where special moment frames are not required to be used, the special moment frames may be discontinued and supported on less ductile systems as long as the requirements for system combinations are followed.

For the situation where special moment frames are required, they should be continuous to the foundation. In cases where the foundation is located below the building's base, provisions for discontinuing the moment frames can be made as long as the seismic forces are properly accounted for and transferred to the supporting structure.

C12.2.5.6 Single-Story Steel Ordinary and Intermediate Moment Frames in Structures Assigned to Seismic Design Category D or E. Ordinary and intermediate moment frames are less ductile than special moment frames; consequently, restrictions are placed on their use in higher Seismic Design Categories. The height limit of 65 feet and the limitations on roof and wall dead load are intended to restrict the use of such systems to metal buildings and similar one-story structures, the design of which is often controlled by wind forces, and which have generally evidenced acceptable performance in past seismic events.

C12.2.5.7 Other Steel Ordinary and Intermediate Moment Frames in Structures Assigned to Seismic Design Category D or E. Compared to the limits in Section 12.2.5.6, this section imposes a stricter height limit because higher loads and additional stories are permitted. Low-rise light-frame structures that are commonly used in residential construction generally have evidenced adequate performance in past seismic events due to their light weight, abundance of lateral force-resisting elements, and general resilience.

C12.2.5.8 Single-Story Steel Ordinary and Intermediate Moment Frames in Structures Assigned to Seismic Design Category F. See Section C12.2.5.6.

C12.2.5.9 Other Steel Intermediate Moment Frame Limitations in Structures Assigned to Seismic Design Category F. The intent of this section is to prohibit the use of steel ordinary moment frames in light-frame construction that does not comply with Section 12.2.5.8.

C12.2.5.10 Shear Wall-Frame Interactive Systems. For structures assigned to Seismic Design Category A or B (where seismic hazard is low), it is usual practice to design shear walls and frames of a shear wall-frame structure to resist lateral forces in proportion to their relative rigidities, considering interaction between the two subsystems at all levels. As discussed in Section C12.2.1, this typical approach would require use of a lower R factor than that defined for shear wall-frame interactive systems. Where the special requirements of this section are satisfied, more reliable performance is expected, justifying a higher R factor.

C12.3 DIAPHRAGM FLEXIBILITY, CONFIGURATION IRREGULARITIES, AND REDUNDANCY

C12.3.1 Diaphragm Flexibility. Most seismic-force-resisting systems have two distinct parts: the horizontal system that distributes lateral forces to the vertical elements and the vertical system that transmits lateral forces between the floor levels and the base of the structure.

The horizontal system may consist of diaphragms or a horizontal bracing system. For the majority of buildings, diaphragms offer the most economical and positive method of resisting and distributing seismic forces in the horizontal plane. Typically, diaphragms consist of metal deck (with or without concrete), concrete slabs, and wood sheathing/decking. While most diaphragms are flat, consisting of the floors of buildings, they also may be inclined, curved, warped, or folded configurations, and most diaphragms have openings.

The diaphragm stiffness relative to the stiffness of the supporting vertical seismic-force-resisting system ranges from flexible to rigid and is important to define. Provisions defining diaphragm flexibility are given in Sections 12.3.1.1 through 12.3.1.3. If a diaphragm cannot be idealized as either flexible or rigid, explicit consideration of its stiffness must be included in the analysis.

The diaphragms in most buildings braced by wood light-frame shear walls are semi-rigid. Because semi-rigid diaphragm modeling is beyond the capability of available software for wood light-frame buildings, it is anticipated that this requirement will be met by evaluating force distribution using both rigid and flexible diaphragm models and taking the worst case of the two. While this is in conflict with common design practice, which typically includes only flexible diaphragm force distribution for wood light-frame buildings, it is one method of capturing the effect of the diaphragm stiffness.

Further detailed discussion of diaphragms can be found in Delebi, et al. (1980) and in an Applied Technology Council report on diaphragms (1981).

C12.3.1.2 Rigid Diaphragm Condition. Span length is included in the deemed-to-comply condition as an indirect measure of the flexural contribution to diaphragm stiffness.

C12.3.2 Irregular and Regular Classification. The configuration of a structure can significantly affect its performance during a strong earthquake producing the ground motion contemplated in the standard. Configuration can be divided into two aspects: horizontal and vertical. Most seismic design provisions were derived for buildings having regular configurations, but earthquakes have shown repeatedly that buildings having irregular configurations suffer greater damage. This situation prevails even with good design and construction. There are several reasons for this poor behavior of irregular structures. In a regular structure, the inelastic response produced by strong ground shaking, including energy dissipation and damage, tends to be well distributed throughout the structure. However, in irregular structures, inelastic behavior can be concentrated by irregularities and result in rapid failure of structural elements in these areas. In addition, some irregularities introduce unanticipated demands into the structure, which designers frequently overlook when detailing the structural system. Finally, the elastic analysis methods typically employed in the design of structures often cannot predict the distribution of earthquake demands in an irregular structure very well, leading to inadequate design in the areas associated with the irregularity. For these reasons, the standard encourages regular configurations and prohibits gross irregularity in buildings located on sites close to major active faults where very strong ground motion and extreme inelastic demands are anticipated.

C12.3.2.1 Horizontal Irregularity. A building may have a symmetric geometric shape without re-entrant corners or wings but still be classified as irregular in plan because of its distribution of mass or vertical seismic-force-resisting elements. Torsional effects in earthquakes can occur even where the centers of mass and resistance coincide. For example, ground motion waves acting on a skew with respect to the building axis can cause torsion. Cracking or yielding in an asymmetric fashion also can cause torsion. These effects also can magnify the torsion due to eccentricity between the centers of mass and resistance. Torsional irregularities are defined to address this concern.

A square or rectangular building with minor re-entrant corners would still be considered regular, but large re-entrant corners creating a crucifix form would produce an irregular configuration. The response of the wings of this type of building generally differs from the response of the building as a whole, and this produces higher local forces than would be determined by application of the standard without modification. Other winged plan configurations (e.g., H-shapes) are classified as irregular even if symmetric due to the response of the wings.

Significant differences in stiffness between portions of a diaphragm at a level are classified as irregularities since they may cause a change in the distribution of seismic forces to the vertical components and create torsional forces not accounted for in the distribution normally considered for a regular building. Figure C12.3-1 illustrates plan irregularities.

Where there are discontinuities in the path of lateral force resistance, the structure cannot be considered to be regular. The most critical discontinuity defined is the out-of-plane offset of vertical elements of the seismic-force-resisting system. Such offsets impose vertical and lateral load effects on horizontal elements that are difficult to provide for adequately.

Where vertical elements of the lateral-force-resisting system are not parallel to or symmetric about major orthogonal axes, the equivalent lateral force procedure of the standard cannot be applied appropriately so the structure is considered to be irregular.

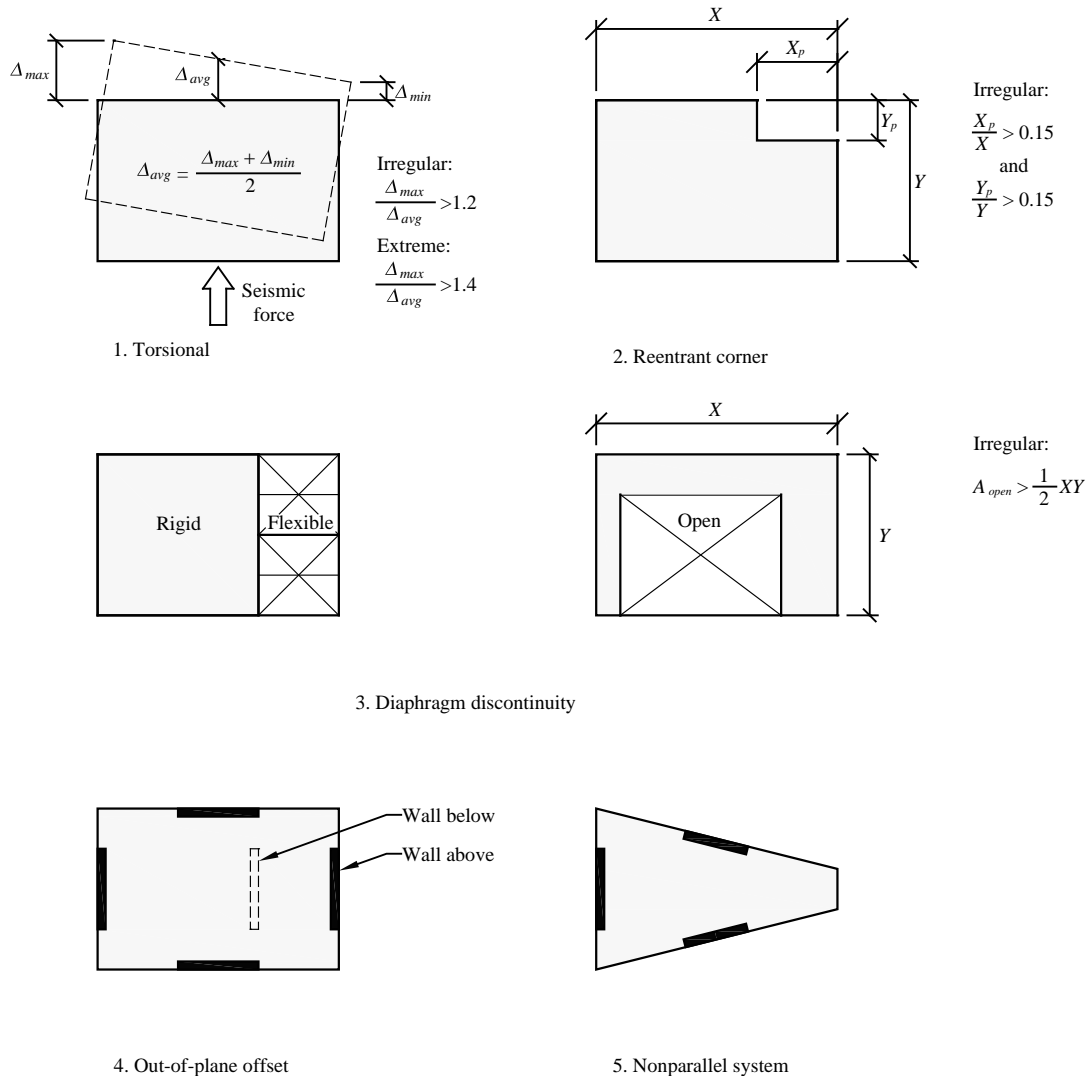

Figure C12.3-1 Building plan irregularities.

C12.3.2.2 Vertical Irregularity. Vertical configuration irregularities affect the responses at the various levels and induce loads at these levels that differ significantly from the distribution assumed in the equivalent lateral force procedure given in Section 12.8. A moment-resisting frame building might be classified as having a vertical irregularity if one story is much taller than the adjoining stories and the design did not compensate for the resulting decrease in stiffness that normally would occur. Figure C12.3-2 illustrates vertical irregularities.

A building is classified as irregular where the ratio of mass to stiffness in adjacent stories differs significantly. This might occur where a heavy mass (e.g., an interstitial mechanical floor) is placed at one level. Irregularity Type 3 in Table 12.3-2 applies regardless of whether the larger dimension is above or below the smaller one. Buildings with a weak-story irregularity tend to develop all of their inelastic behavior and consequent damage at the weak story, possibly leading to collapse. Section 12.3.3.2 provides an exception for Seismic Design Category B or C structures where essentially elastic response of the weak story is expected.

C12.3.3 Limitations and Additional Requirements for Systems with Structural Irregularities.

C12.3.3.1 Prohibited Horizontal and Vertical Irregularities in Seismic Design Categories D through F. The irregularity prohibitions of this section stem from poor performance in past earthquakes and the potential to concentrate large inelastic demands in certain portions of the structure. Even when such irregularities are permitted, they should be avoided whenever possible in all structures.

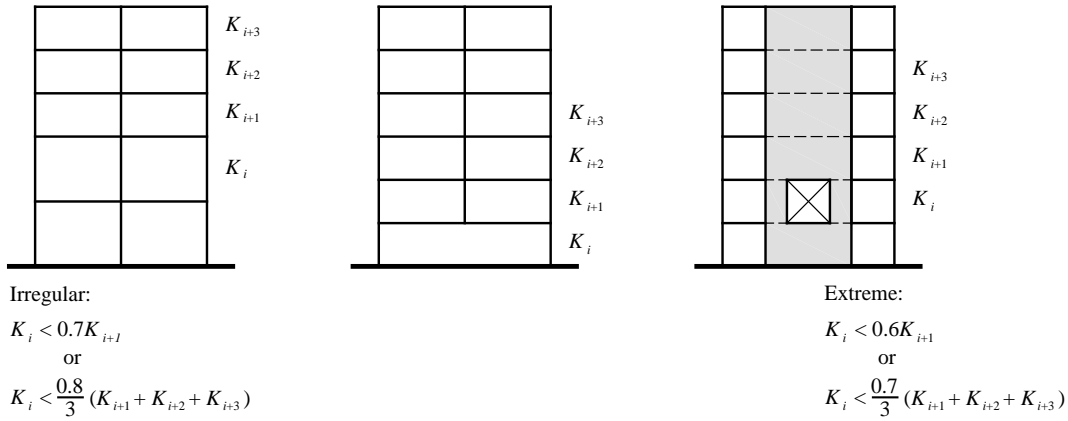

1. Stiffness – Soft Story

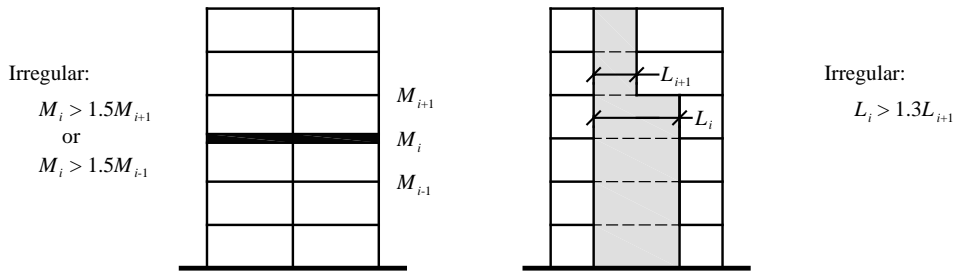

2. Weight (Mass)

3. Geometric

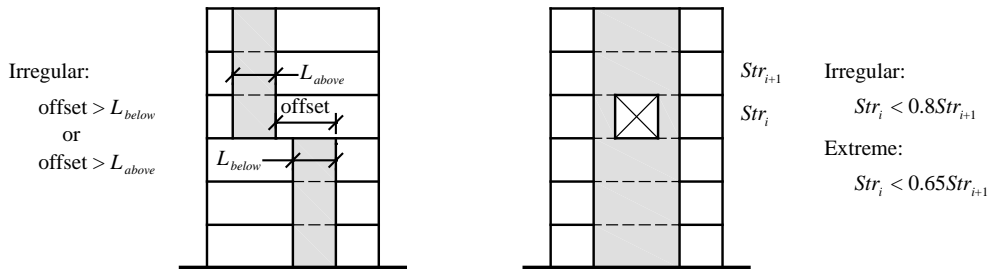

4. In-Plane Discontinuity

5. Lateral Strength – Weak Story

Figure C12.3-2 Building vertical irregularities.

C12.3.3.2 Extreme Weak Stories. Since extreme weak story irregularities are prohibited for buildings located in Seismic Design Categories D, E and F, the limitations and exceptions in this section apply only to buildings assigned to Seismic Design Category B or C.

C12.3.3.3 Elements Supporting Discontinuous Walls or Frames. The purpose of this requirement is to protect the supporting elements from overload caused by overstrength of a discontinued seismic-force-resisting element. Columns, beams, slabs, or trusses may be subject to such failure so all are included in the design requirement. Overload may result from forces in either the downward or upward direction; therefore, both possibilities must be considered. Such load reversals may be especially problematic for reinforced concrete beams, weaker top laminations of glulam beams, unbraced flanges of steel beams, and steel trusses.

The connection between the discontinuous element and the supporting member must be adequate to transmit the forces for which the discontinuous element is designed. For example, where the discontinuous element must be designed using the load combinations of Section 12.4.3, as is the case for a steel column in a braced frame or moment frame, its connection to the supporting member must be designed using the same load combinations. Since concrete shear walls are not required to be designed using the load combinations of Section 12.4.3, the connection between a discontinuous shear wall and the supporting member may be designed using the loads associated with the shear wall and not the load combinations with overstrength factor.

C12.3.3.4 Increase in Forces Due to Irregularities for Seismic Design Categories D through F. The irregularities listed may result in loads that are distributed differently than assumed in the equivalent lateral force procedure of Section 12.8, especially as related to the interconnection of the diaphragm with vertical elements of the seismic-force-resisting system. The 25 percent increase in force is intended to account for this difference. Where the load combinations with overstrength apply, no further increase is warranted.

C12.3.4 Redundancy. The desirability of redundancy, or multiple lateral-force-resisting load paths, has long been recognized. The redundancy provisions of this section reflect the belief that an excessive loss of story shear strength or development of an extreme torsional irregularity may lead to structural failure. The redundancy factor determined for each direction may differ.

C12.3.4.1 Conditions Where Value of ρ is 1.0. This section provides a convenient list of conditions where ρ is 1.0.

C12.3.4.2 Redundancy Factor, ρ , for Seismic Design Category D through F. There are two approaches to establishing a redundancy factor of 1.0. Where neither condition is satisfied, ρ is taken equal to 1.3. It is permitted to take ρ equal to 1.3 without checking either condition.

The first approach is a check of the elements outlined in Table 12.3-3 for cases where the story shear exceeds 35 percent of the base shear. Parametric studies (conducted by Building Seismic Safety Council Technical Subcommittee 2 but unpublished) were used to select the 35 percent value. Those studies indicated that stories with at least 35 percent of the base shear include all stories of low-rise buildings (buildings up to 5 to 6 stories) and about 87 percent of the stories of tall buildings. The intent of this limit is to exclude penthouses and the uppermost stories from the redundancy requirements.

This approach requires the removal (or loss of moment resistance) of an individual lateral-force-resisting element to determine its effect on the remaining structure. If the removal of elements, one-by-one, does not result in more than a 33 percent reduction in story strength or an extreme torsional irregularity, ρ may be taken as 1.0. For this evaluation, the determination of story strength requires an in-depth calculation. The intent of the check is to use a simple measure (elastic or plastic) to determine whether an individual member has a significant effect on the overall system. If the original structure has an extreme torsional irregularity to begin with, the resulting ρ is 1.3. Figure C12.3-3 presents a flowchart for implementing the redundancy requirements.

As indicated in the table, braced frame, moment frame, shear wall, and cantilever column systems must conform to redundancy requirements. Dual systems also are included but, in most cases, are inherently redundant. Shear walls or wall piers with a height-to-length aspect ratio greater than 1.0 within any story have been included; however, the required design of collector elements and their connections for Ω_0 times the design force may address the key issues. In order to satisfy the collector force requirements, a reasonable number of shear walls usually is required. Regardless, shear wall systems are addressed in this section so that either an adequate number of wall elements is included or the proper redundancy factor is applied. For wall piers, the height is taken as the height of the adjacent opening and generally is less than the story height.

The second approach is a deemed-to-comply condition wherein the structure is regular and has a specified arrangement of seismic-force-resisting elements to qualify for ρ of 1.0. As part of the parametric study, simplified braced frame and moment frame systems were investigated to determine their sensitivity to the analytical redundancy criteria. This simple deemed-to-comply condition is consistent with the results of the study.

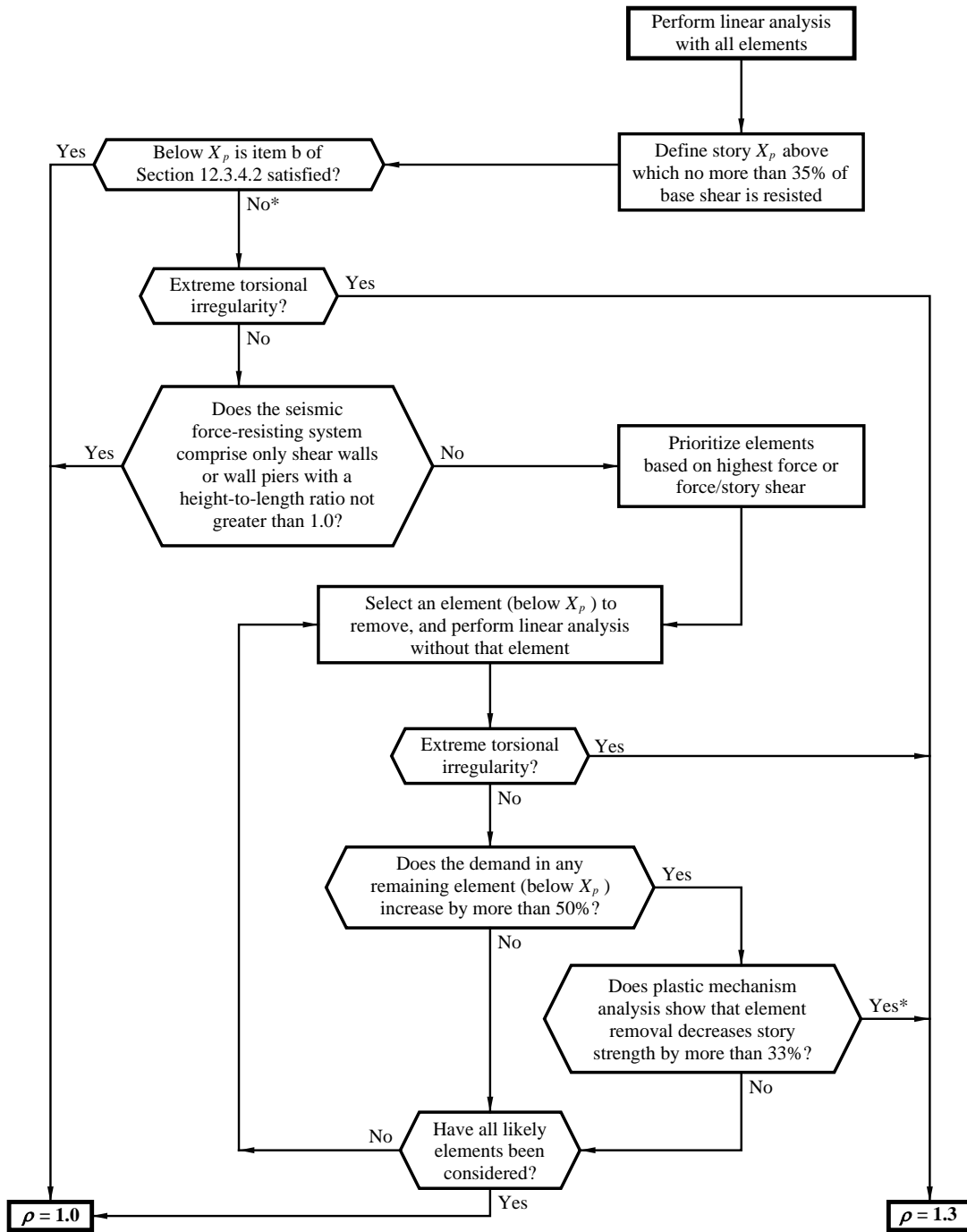

* or not considered

Figure C12.3-3 Calculation of the redundancy factor, ρ .

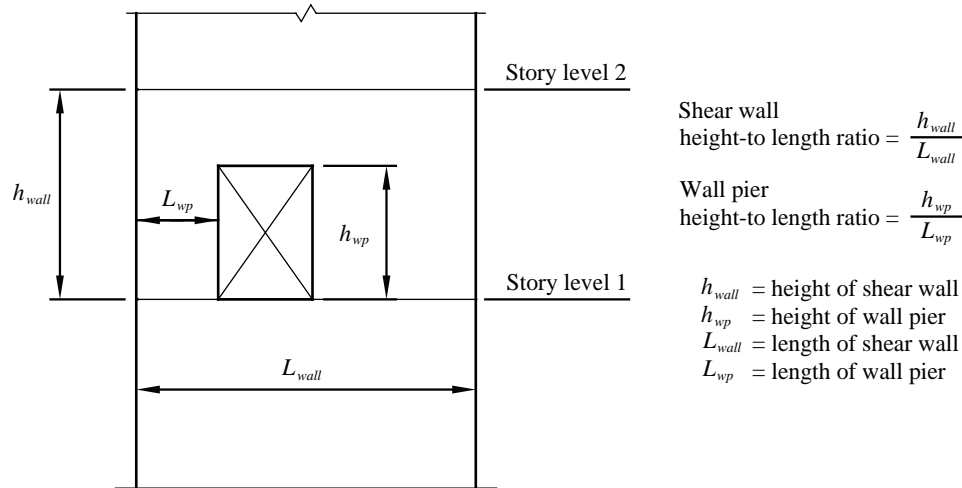

Figure C12.3-4 Shear wall and wall pier height-to-length ratios.

C12.4 SEISMIC LOAD EFFECTS AND COMBINATIONS

C12.4.1 Applicability. Structural elements designated by the engineer as part of the seismic-force-resisting system typically are designed directly for seismic load effects. None of the seismic forces associated with the design base shear are formally assigned to structural elements that are not designated as part of the seismic-force-resisting system, but such elements must be designed using the load conditions of Section 12.4 and must accommodate the deformations resulting from application of seismic loads.

C12.4.2 Seismic Load Effect. Section 12.4 presents the required combinations of seismic forces with other loads. The load combinations are taken from the basic load combinations of Chapter 2 of the standard with further elaboration of the seismic load effect, E . The seismic load effect includes horizontal and vertical components. For strength design, the effect of vertical seismic forces, E_v , is based on an assumed effective vertical acceleration of $0.2S_{DS}$ times gravity.

It may be helpful to recognize that the quantities E_h and E_v are the effects of loads, not the loads themselves. They can be tension or compression axial forces, shear, bending moments, or torsional moments. For a one-story shear wall, application of the horizontal seismic forces from V causes overturning moment and shear in the wall, both of which are E_h effects. The factor $0.2 S_{DS}$ times gravity dead load corresponds to an E_v load effect that increases or decreases the axial force in the wall. In this simple example, an E_h force or moment is never added directly to an E_v force or moment because the former affects only moment and shear, while the latter affects only axial force.

While the shear and moment are independent of the axial force, the capacity check of the wall may need to include all three terms (or certainly moment and axial force) simultaneously.

For a diagonal brace that carries earthquake and gravity load, application of the horizontal seismic forces from V causes a brace force that has both horizontal and vertical components, and the factor $0.2 S_{DS}$ times dead load produces a load effect that also affects both the horizontal and vertical components of axial force. In this case the brace force is based on $E_h \pm E_v$. Section 12.4.2.3 presents the load combinations written using the separate horizontal and vertical load effects that constitute E .

The $0.2S_{DS}$ vertical acceleration effect is required to be considered in the design of all members of a structure—even those that are not part of the seismic-force-resisting system. For example, design of a gravity load-resisting prestressed concrete girder may be governed by the dead and earthquake condition, where $0.2S_{DS}D$ is subtracted from the dead load. This could be the controlling condition for tension at the top of the girder.

C12.4.3 Seismic Load Effect Including Overstrength Factor. Certain structural elements or actions, such as collectors in Seismic Design Categories C through F or columns supporting discontinuous walls, are required to be designed for seismic load combinations with overstrength. In such cases the seismic load effect, E_m , has its horizontal component multiplied by the overstrength factor Ω_0 , as indicated in Section 12.4.3.

C12.4.4 Minimum Upward Force for Horizontal Cantilevers for Seismic Design Categories D through F. In Seismic Design Categories D, E, and F, horizontal cantilevers are designed for an upward force that results from an effective vertical

acceleration of 1.2 times gravity. This is to provide some minimum strength in the upward direction and to account for possible dynamic amplification of vertical ground motions resulting from the vertical flexibility of the cantilever. The requirement is not applied to downward forces on cantilevers, for which the typical load combinations are used.

C12.5 DIRECTION OF LOADING

Seismic forces are delivered to a building through ground accelerations that may approach from any direction relative to the orthogonal directions of the building; therefore, seismic effects are expected to develop in both directions simultaneously. The standard requires structures to be designed for the most critical loading effects from seismic forces applied in any direction, and the procedures outlined in this section are deemed to satisfy that requirement.

The orthogonal combination procedure combines the effects from 100 percent of the seismic load applied in one direction with 30 percent of the seismic load applied in the perpendicular direction. Combining effects for seismic loads in each direction and accidental torsion results in 16 load combinations as follows:

Orthogonal load combinations

where :

$$Q_E = +/- Q_{E_{X+AT}} +/- 0.3Q_{E_Y}$$

Q_{E_Y} = effect of Y-direction load at the center of mass
(Section 12.8.4.2)

$$Q_E = +/- Q_{E_{X-AT}} +/- 0.3Q_{E_Y}$$

Q_{E_X} = effect of X-direction load at the center of mass
(Section 12.8.4.2)

$$Q_E = +/- Q_{E_{Y+AT}} +/- 0.3Q_{E_X}$$

AT = accidental torsion computed in accordance with
Section 12.8.4.2

$$Q_E = +/- Q_{E_{Y-AT}} +/- 0.3Q_{E_X}$$

For horizontal structural elements such as beams and slabs, orthogonal effects may be minimal; however, for vertical elements of the seismic-force-resisting system that participate in both orthogonal directions, the design likely will be governed by these combinations.

Orthogonal combinations should not be confused with modal combinations such as the square root of the sum of the squares (SRSS) or complete quadratic combination (CQC) technique.

The maximum effect of seismic forces, Q_E , from orthogonal load combinations must be modified by the redundancy factor, ρ , or the overstrength factor, Ω_o , and consider the effects of vertical seismic forces, E_V , in accordance with Section 12.4, to obtain the seismic load effect, E .

C12.6 ANALYSIS SELECTION PROCEDURE

Table 12.6-1 applies only to buildings without seismic isolation (Chapter 17) or passive energy devices (Chapter 18).

The procedures addressed in Table 12.6-1 are equivalent lateral force (ELF) analysis (Section 12.8), modal response spectrum (MRS) analysis (Section 12.9), linear response history (LRH) analysis, and nonlinear response history (NRH) analysis. Requirements for performing response history analysis are provided in Chapter 16. Nonlinear static (pushover) analysis is not addressed in the standard.

The value of T_s ($= S_{D1}/S_{DS}$) depends on the site class because S_{DS} and S_{D1} include such effects. Where ELF is not allowed, analysis must be performed using modal response spectrum or response history analysis.

ELF is not allowed for buildings with the listed irregularities because it assumes a gradually varying distribution of mass and stiffness along the height and negligible torsional response. The $3.5T_s$ limit recognizes that higher modes are more significant in taller buildings (Lopez and Cruz, 1996; Chopra, 2007) such that the ELF method may underestimate the design base shear and may not predict correctly the vertical distribution of seismic forces.

C12.7 MODELING CRITERIA

C12.7.1 Foundation Modeling. Structural systems consist of three interacting components: the structural framing (girders, columns, walls, diaphragms), the foundation (footings, piles, caissons), and the supporting soil. The ground motion that a structure experiences, as well as the response to that ground motion, depends on the complex interaction between these components.

Those aspects of ground motion that are affected by site characteristics are assumed to be independent of the structure-foundation system as these effects would occur in the free-field in the absence of the structure. Hence, site effects are considered separately (Sections 11.4.2 through 11.4.4 and Chapters 20 and 21).

Given a site-specific ground motion or response spectrum, the dynamic response of the structure will depend on the foundation system and on the characteristics of the soil that support the system. The dependence of the response on the structure-foundation-soil system is referred to as soil-structure interaction. Such interactions will usually, but not always, result in a reduction of base shear. This reduction in shear is due to the flexibility of the foundation-soil system and an associated lengthening of the period of vibration of the structure. In addition, the soil system may provide an additional source of damping. However, that total displacement typically increases with soil-structure interaction.

If the foundation is considered to be rigid, the computed base shears usually will be conservative, and it is for this reason that rigid foundation analysis is allowed. The designer may ignore soil-structure interaction or may consider it explicitly in accordance with Section 12.13.3 or implicitly in accordance with Chapter 19.

C12.7.2 Effective Seismic Weight. During an earthquake, the structure accelerates laterally, and these accelerations of the structural mass produce inertial forces. These inertial forces, accumulated over the height of the structure, produce the design base shear.

When a building vibrates during an earthquake, only that portion of the mass or weight that is physically tied to the structure needs to be considered as effective. Hence, live loads (e.g., loose furniture, loose equipment, and human occupants) need not be included. However, certain types of live loads such as storage loads may develop inertial forces, particularly where they are densely packed.

Also considered as effective weight is all permanently attached equipment (e.g., air conditioners, elevator equipment, and mechanical systems), movable partitions (a minimum of 10 psf is required), and 20 percent of significant roof snow load. The full snow load need not be considered because maximum snow load and maximum earthquake load are unlikely to occur simultaneously and loose snow does not move with the roof.

C12.7.3 Structural Modeling. The development of a mathematical model of a structure is always required because the story drifts and the design forces in the structure cannot be computed without such a model. In some cases, the mathematical model can be as simple as a free-body diagram as long that model can appropriately capture the strength and stiffness of the structure.

The most realistic analytical model is three-dimensional, includes all sources of stiffness (and flexibility) of the structure and the soil-foundation system as well as P-delta effects, and allows for nonlinear inelastic behavior in all parts of the structure-foundation-soil system. Development of such an analytical model is very time consuming, and such analysis is rarely warranted for typical building designs performed in accordance with the standard. Instead of performing a nonlinear analysis, inelastic effects are accounted for indirectly in the linear analysis methods by means of the response modification factor, R , and the deflection amplification factor, C_d .

Using modern software, it often is more difficult to decompose a structure into planar models than it is to develop a full three-dimensional model so three-dimensional models now are commonplace. Increased computational efficiency has reduced the motivation to model rigid diaphragms, allowing for easy and efficient modeling of diaphragm flexibility. Three-dimensional models are required where the structure has torsional irregularities, out-of-plane offset irregularities, or nonparallel system irregularities.

In general, the same three-dimensional model may be utilized for equivalent lateral force, modal response spectrum, and linear response history analysis. The response spectrum and linear response history models require a realistic modeling of structural mass, and the response history method also requires an explicit representation of inherent damping. Five percent critical damping is automatically included in the modal response spectrum approach. See Chapter 16 and the related commentary for additional information on linear and nonlinear response history analysis.

It is well known that deformations in the panel zones of the beam-column joints of steel moment frames are a significant source of flexibility. Two different mechanical models for including such deformations are summarized in Charney and Marshall (2006). These methods apply to both elastic and inelastic systems. For elastic structures, centerline analysis provides reasonable, but not always conservative, estimates of frame flexibility. Fully rigid end zones should not be used, as this will always result in an overestimation of lateral stiffness in steel moment-resisting frames. Partially rigid end zones may be justified in certain cases such as where doubler plates are used to reinforce the panel zone.

Including the effect of composite slabs on the stiffness of beams and girders may be warranted in some circumstances. Where composite behavior is included, due consideration should be paid to the reduction in effective composite stiffness for portions of the slab in tension (Schaffhausen and Wegmuller, 1977; Liew, et al., 2001)

For reinforced concrete buildings, it is important to address the effects of axial, flexural, and shear cracking in modeling the effective stiffness of the structural components. Determining appropriate effective stiffness of the structural components should take into consideration the anticipated demands on the components, their geometry, and the complexity of the model. Recommendations for computing cracked section properties may be found in Paulay and Priestley (1992) and similar texts.

C12.7.4 Interaction Effects. The interaction requirements are intended to prevent unexpected failures in members of moment-resisting frames. Figure C12.7-1 illustrates a typical situation where masonry infill is used, and this masonry is fitted tightly against reinforced concrete columns. Since the masonry is much stiffer than the columns, column hinges form at the top of column and at the top of the masonry rather than at the top and bottom of the column. If the column flexural capacity is M_p , the shear in the columns increases by the factor H/h , and this may cause an unexpected nonductile shear failure in the columns. Many building collapses have been attributed to this effect.

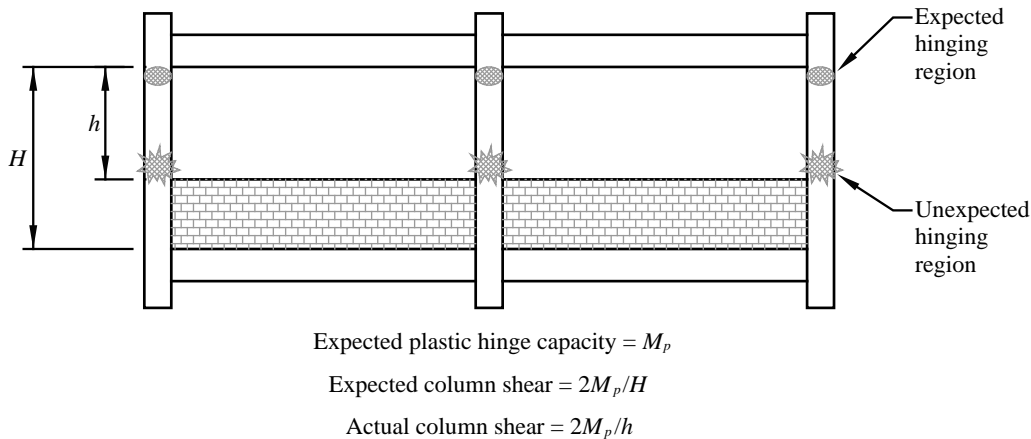

Figure C12.7-1 Undesired interaction effects.

C12.8 EQUIVALENT LATERAL FORCE PROCEDURE

The equivalent lateral force (ELF) procedure provides a simple way to incorporate the effects of inelastic dynamic response into a linear static analysis. This procedure is useful in preliminary design of all structures and is allowed for final design of the vast majority of structures. The procedure is valid only for structures without significant discontinuities in mass and stiffness along the height, where the dominant response to ground motions is in the horizontal direction without significant torsion.

The ELF procedure has three basic steps:

1. Determine the seismic base shear,
2. Distribute the shear vertically along the height of the structure, and
3. Distribute the shear horizontally across the width and breadth of the structure.

Each of these steps is based on a number of simplifying assumptions. A broader understanding of these assumptions may be obtained from any structural dynamics textbook that emphasizes seismic applications.

C12.8.1 Seismic Base Shear

C12.8.1.1 Calculation of Seismic Response Coefficient. Equation 12.8-1 simply expresses the base shear as the product of the effective seismic weight, W , and a response coefficient, C_s . The response coefficient is a spectral pseudoacceleration, in g units, which has been modified by R and I to account for inelastic behavior and to provide for improved performance for high occupancy or essential structures.

There are five equations for determining the response coefficient C_s ; the first three are plotted in Figure C12.8-1.

Equation 12.8-2, representing the constant acceleration part of the spectrum, controls where $0.0 < T < T_s$. As shown in Table C12.6-1 (which provides values of $3.5T_s$), T_s is a function of seismicity and site. It may be as low as 0.2 seconds for low hazard regions on Site Class B or as high as 0.9 seconds in high hazard regions on Site Class E.

The true pseudoacceleration response spectrum transitions to the peak ground acceleration as the period approaches zero. This transition is not used in the ELF method. One reason is that simple reduction of the response spectrum by $(1/R)$ in the very short period region would exaggerate inelastic effects.

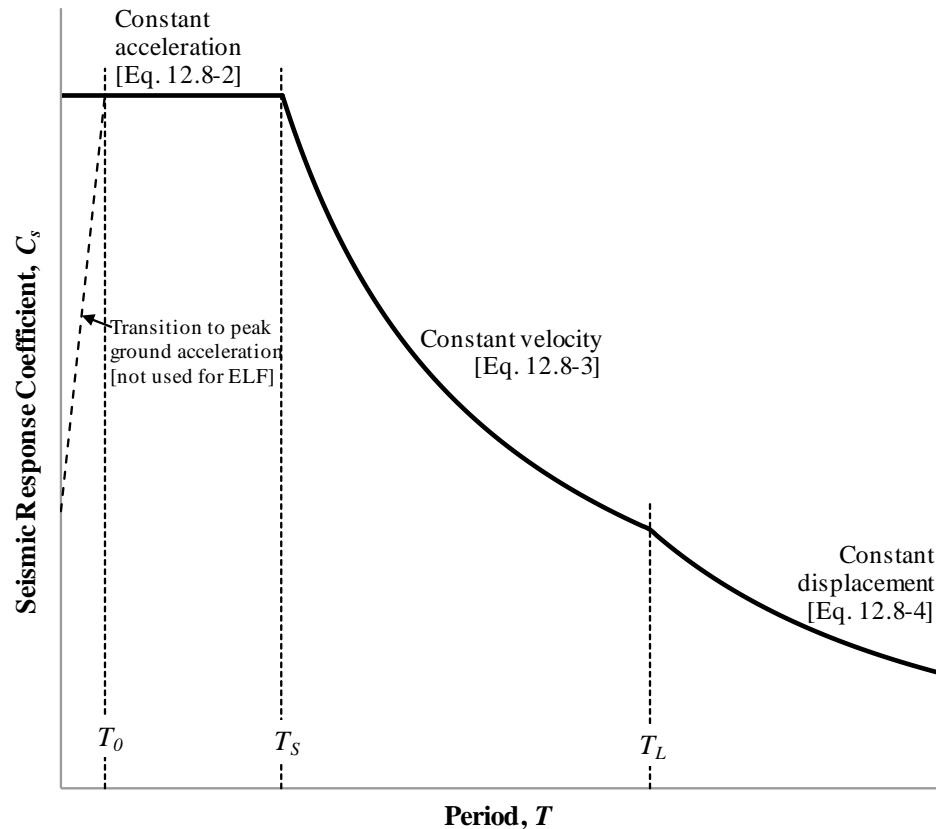

Figure C12.8-1 Seismic response coefficient versus period.

Equation 12.8-3, representing the constant velocity part of the spectrum, controls where $T_s < T < T_L$. In this region, the seismic response coefficient is inversely proportional to period, and the pseudovelocity (pseudoacceleration divided by circular frequency, ω), is constant. T_L , the long-period transition period, is provided in Figures 22-15 through 22-20. T_L ranges from 4 seconds in the northcentral conterminous states and western Hawaii to 16 seconds in the Pacific Northwest and in western Alaska.

Equation 12.8-4, representing the constant displacement part of the spectrum, controls where $T > T_L$. Given the current mapped values of T_L , this equation only affects tall and flexible structures.

Equation 12.8-5 is the minimum base shear and provides a (working stress) strength of approximately 3 percent of the weight of the structure (Seismology Committee, Structural Engineers Association of California, 1996). This minimum base shear was originally enacted in 1933 by the state of California's Riley Act.

Equation 12.8-6 applies to sites near major active faults (as reflected by values of S_f) where pulse effects can increase long-period demands.

C12.8.1.2 Soil-Structure Interaction Reduction. Soil-structure interaction, which can influence significantly the dynamic response of structures to earthquakes, is addressed in Chapter 19.

C12.8.1.3 Maximum S_s Value in Determination of C_s . The maximum value of S_s was created as hazard maps were revised in 1997. The cap on S_s reflects engineering judgment about performance of code-complying buildings in past earthquakes so the height, period, and regularity conditions required for use of the limit are very important qualifiers.

C12.8.2 Period Determination. The fundamental period of the structure, T , is used to determine the design base shear as well as the exponent k that establishes the distribution of the shear along the height of the structure. Equation 12.8-7 is an

empirical relationship determined through statistical analysis of the measured response of buildings in California. Figure C12.8-2 illustrates such data for various structures with steel moment resisting frames.

Since the empirical expression is based on the lower bound of the data, it produces a lower bound for the period of a building of given height. This lower bound period, used in Equations 12.8-3 and 12.8-4, provides a conservative estimate of base shear.

The fundamental period determined from a rational analysis may be used in design unless it exceeds the approximate period times the coefficient provided in Table 12.8-1. This period limit prevents the use of unusually low ELF base shear for design of buildings (or computational models) that are overly flexible. The coefficients in the table have two effects. First, the conservatism of lower bound empirical formulas for T_a is removed. Second, the period is increased in regions of lower seismicity as buildings in such areas generally are more flexible (and, hence, have longer periods) than buildings in regions of higher seismicity.

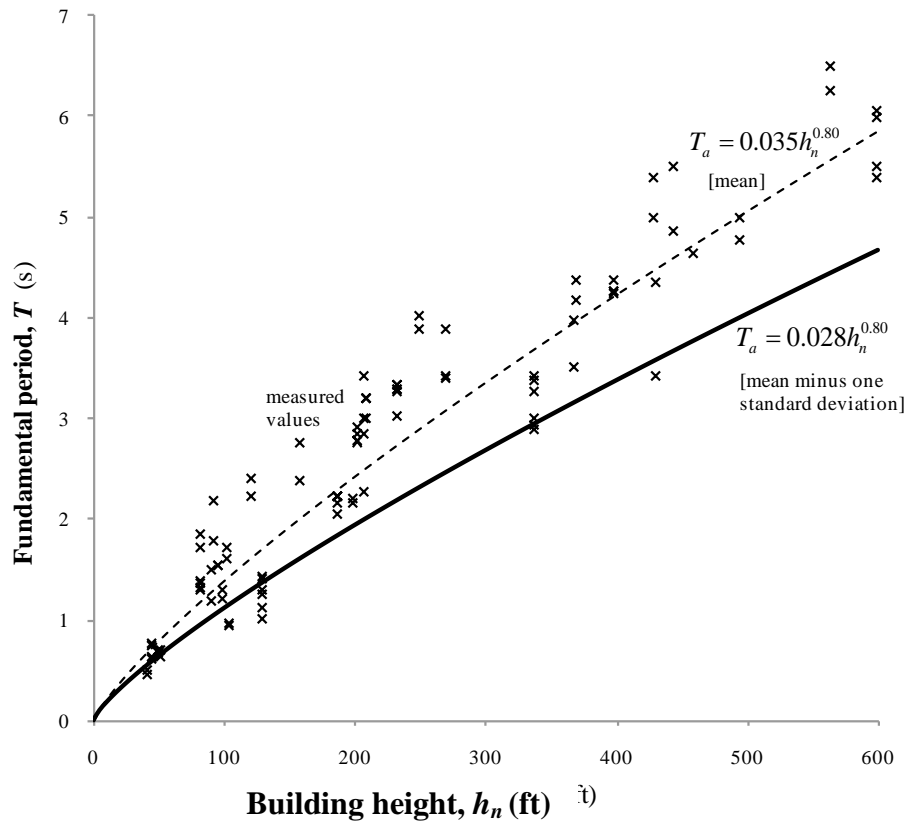

Figure C12.8-2 Variation of fundamental period with building height.

C12.8.3 Vertical Distribution of Seismic Force. Equation 12.8-12 is based on the simplified first mode shape shown in Figure C12.8-3. In the figure, F_x is the inertial force at level x , which is simply the total acceleration at level x times the mass at level x . The base shear is the sum of these inertial forces, and Equation 12.8 simply gives the ratio of the force at level x to the total base shear.

The deformed shape of the structure of Figure C12.8-3 is a function of the exponent k , which is related to the fundamental period of vibration of the structure. The variation of k with T is illustrated in Figure C12.8-4. The exponent k is intended to approximate the effect of higher modes, which are generally more dominant in structures with a longer fundamental period of vibration. Lopez and Cruz (1996) discuss the factors that influence higher modes of response. Although the actual first mode shape for a structure is also a function of the type of seismic-force-resisting system, that effect is not reflected in these equations.

The horizontal forces computed using Equation 12.8-12 do not reflect the actual inertial forces imparted on a structure at any particular time. Instead, they are intended to provide design story shears that are consistent with enveloped results from more accurate analysis (Chopra and Newmark, 1980).

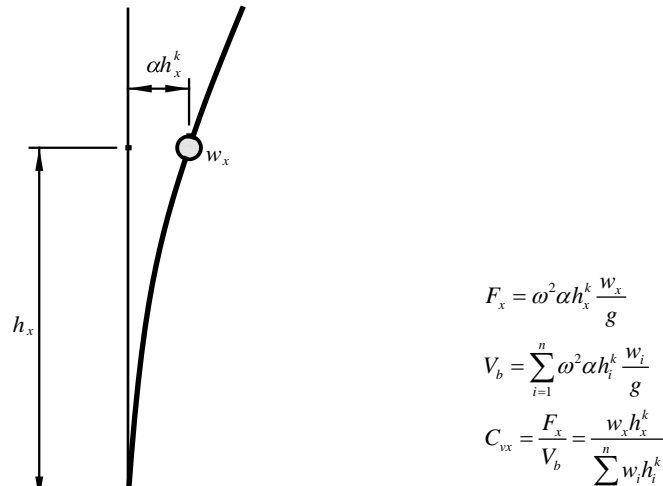
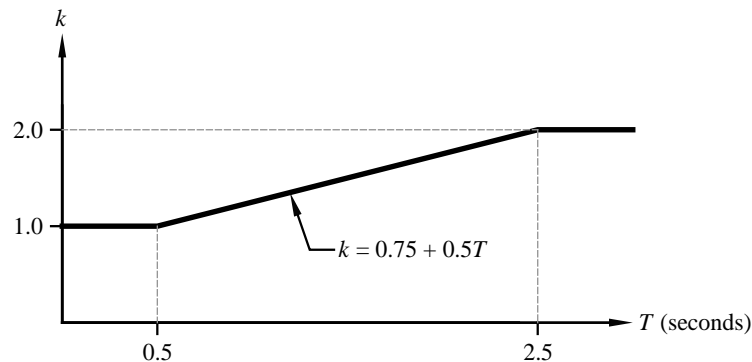

Figure C12.8-3 Basis of Equation 12.8-12.

C12.8.4 Horizontal Distribution of Forces. Within the context of an elastic ELF analysis, the distribution of lateral forces to various seismic-force-resisting elements depends on the type, geometric arrangement, and vertical extents of the resisting elements and on the shape and flexibility of the floor diaphragms. Because seismic-force-resisting elements are expected to respond inelastically to design ground motions, the distribution of forces to the various elements also depends on the strength of the elements and their sequence of yielding. Clearly, such effects cannot be captured accurately by a linear elastic static analysis (Paulay, 1997). Nonlinear dynamic analysis is too cumbersome to be applied to the design of most buildings so other approximate methods are used.

Figure C12.8-4 Variation of exponent k with period T .

Of particular concern is the torsional response of the structure during the earthquake. This response has been observed in structures that are designed to be nearly symmetric in plan and layout of seismic-force-resisting systems (De La Liera and Chopra, 1994). This torsional response is due to a variety of “accidental” eccentricities that exist due to uncertainties in quantifying the mass and stiffness distribution of the structure, as well as torsional components of ground motion that are not included explicitly in code-based designs (Newmark and Rosenbleuth, 1971).

C12.8.4.1 Inherent Torsion. When lateral forces in a particular direction are applied statically at each story of a building with rigid diaphragms, torsional displacement (twisting about the vertical axis) occurs if the centers of stiffness and mass of each story are not perfectly coincident in plan. When three-dimensional analysis is used, this inherent torsion is included automatically. When planar analysis is used, the centers of mass and rigidity for each story must be determined explicitly. Unfortunately, it is difficult to determine the center of rigidity for a multistory building to compute the inherent torsion; the center of rigidity for a particular story depends on the configuration of the seismic-force-resisting elements above and below that story and may be load dependent (Chopra and Goel, 1991).

For buildings with fully flexible diaphragms (as defined in Section 12.3), vertical elements are assumed to resist inertial forces from the mass that is tributary to the elements, but with no explicitly computed torsion. No diaphragm is perfectly flexible, so some torsional forces always develop even when they are ignored.

C12.8.4.2 Accidental Torsion. Even for perfectly symmetric buildings, the true locations of the centers of mass and rigidity are uncertain. As discussed in Section C12.8.4, other effects also may produce torsion. The requirement to consider accidental torsion is intended to address this concern.

Accidental and inherent torsions result in forces that must be combined with those obtained from the application of the lateral story forces; all components must be designed for the maximum effects determined considering positive accidental torsion, negative accidental torsion, and no accidental torsion.

C12.8.4.3 Amplification of Accidental Torsion. Equation 12.8-14 was developed by the SEAOC “seismology committee to encourage buildings with good torsional stiffness” (Structural Engineers Association of California, 1999).

In calculating the torsional amplification factor, A_x , the applied loads include inherent and accidental torsion, but with no further amplification; the calculation is not iterative.

Figure C12.8-5 illustrates the effect of Equation 12.8-14 for a symmetric rectangular building with various aspect ratios (L/B) where the seismic-force-resisting elements are positioned at a variable distance (defined by α) from the center of mass in each direction. Each element is assumed to have the same stiffness. The structure is loaded parallel to the short direction with an eccentricity of 0.05L.

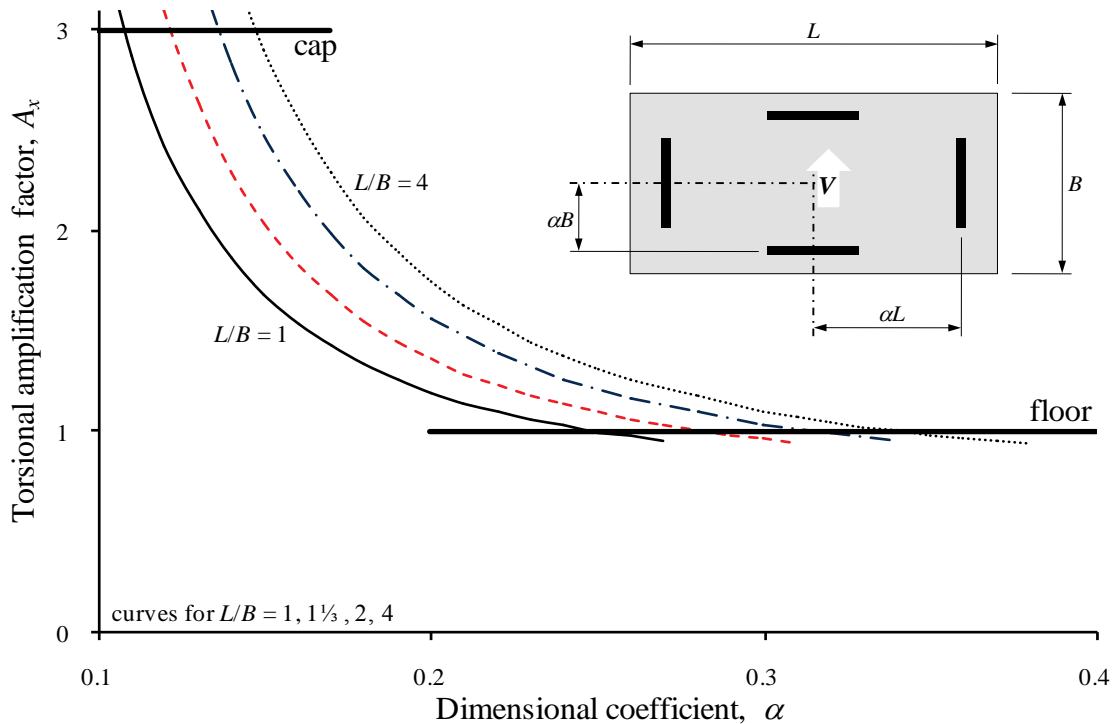

Figure C12.8-5 Amplification factor for symmetric rectangular buildings.

For α equal to 0.5, these elements are at the perimeter of the buildings, and for α equal to 0.0, they are at the center (providing no torsional resistance). For a square building ($L/B = 1.00$), the torsional amplification factor is greater than 1.0 where α is less than 0.25 and increases to the maximum of 3.0 where α is equal to 0.11. For a rectangular building with L/B equal to 4.00, the amplification factor is greater than 1.0 where α is less than 0.34 and increases to 3.0 where α is equal to 0.15. For the range of aspect ratios investigated, A_x is equal to 1.0 where α is greater than 0.34 and A_x reaches its maximum value of 3.0 where ($\alpha < 0.11$ to 0.15).

C12.8.6 Story Drift Determination. Equation 12.8-15 is used to estimate inelastic deflections, which are then used to calculate design story drifts. These story drifts must be less than the allowable story drifts of Table 12.12-1. For buildings without torsional irregularity, computations are performed using deflections at the centers of mass of adjacent stories. For Seismic Design Category C, D, E, or F structures that are torsionally irregular, Section 12.12.1 requires that drifts be computed along the edges of the structure.

The term C_d in Equation 12.8-15 amplifies the displacements from elastic analysis at design level forces, which are reduced by R .

Figure C12.8-6 illustrates the relationships between elastic response; response to reduced design-level forces; and the expected inelastic response. If the structure remained elastic during an earthquake, the force would be V_E , and the corresponding displacement would be δ_E . Note that V_E does not include the reduction factor, R , which accounts primarily for ductility and overstrength. According to the equal displacement “rule” of seismic design, the maximum displacement of an inelastic system is approximately equal to that of an elastic system with the same initial stiffness. This condition has been observed for structures idealized with bilinear inelastic response and a fundamental period greater than T_s . For shorter period structures, peak displacement of an inelastic system tends to exceed that of the corresponding elastic system. Since the forces used for design include the response modification coefficient, R , the resulting displacements are too small and must be amplified.

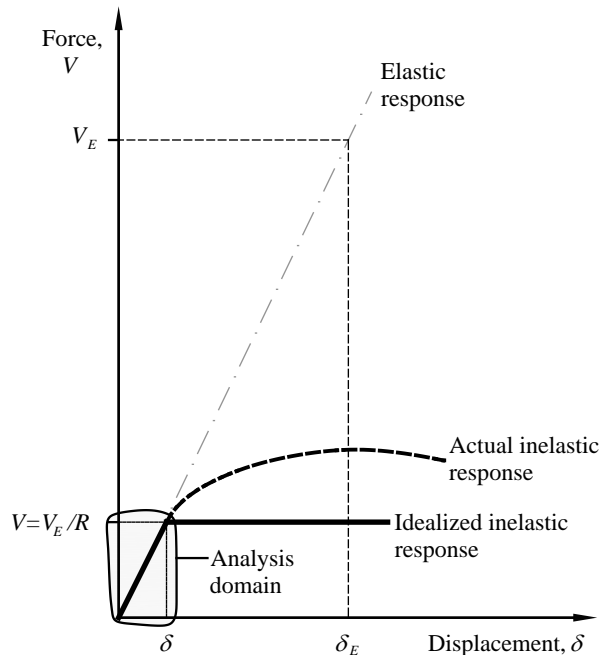

Figure C12.8-6 Displacements used to compute drift.

This analysis domain is shown in Figure C12.8-6. Because of overstrength and associated stiffness increases, the actual inelastic response differs from the idealized inelastic response; the actual displacement of the system may be less than R times δ . The standard accounts for this difference by multiplying the fictitious (design-level) elastic displacements δ by the factor C_d , which is usually less than R .

The design forces used to compute δ_{xe} include the importance factor, I , so Equation 12.8-15 includes I in the denominator. This is appropriate since the allowable story drifts (except for masonry shear wall structures) in Table 12.12-1 are more stringent for higher occupancy categories.

C12.8.6.1 Minimum Base Shear for Computing Drift. Except for period limits (as described in Section C12.8.6.2), all of the requirements of Section 12.8 (including minimum base shears and force distributions) must be satisfied where computing drift for ELF analysis.

C12.8.6.2 Period for Computing Drift. Where the response spectrum of Section 11.4.5 or the corresponding equations of Section 12.8.1 are used and the structural period is less than TL, displacements increase with increasing period (even though forces may decrease). Section 12.8.2 applies a period limit so that design forces are not too low, but if the lateral forces used to compute drifts are inconsistent with the forces corresponding to the computed period, displacements will be overestimated. Therefore, the standard allows the determination of drift using forces that are consistent with the computed period of vibration of the structure.

Computed periods greater than $C_u T_a$ are common, particularly for moment frames. In such cases the seismic design forces used to proportion strength may produce displacements that violate drift limits, whereas displacements based on the computed period will satisfy drift limits.

The more flexible the structure, the more likely it is that P-delta effects will ultimately control the design. Computed periods that are significantly greater than (perhaps more than 1.5 times) $C_u T_a$ may indicate a modeling error.

C12.8.7 P-delta Effects. P-delta effects influence both the stiffness and strength of structures. Figure C12.8-7 shows idealized static force-displacement responses for a simple, one-story structure (such as a cantilevered column). The stiffness and strength of the structure without considering P-delta effects (condition 0) are represented by K_0 and V_0 . When P-delta effects are considered (condition 1), the related quantities are K_1 and V_1 . Since the two model conditions are for the same structure, inherent capacity of the structure is the same in either condition, the yield displacement is the same ($\delta_{0y} = \delta_{1y} = \delta_y$).

The geometric stiffness of the structure, K_G , is equal to P/h , where P is the total gravity load and h is the story height. K_G is negative where gravity loads cause compression in the story.

The stability coefficient, θ , is defined as the absolute value of the geometric stiffness divided by the elastic stiffness. From Figure C12.8-7, $K_0 = V_{0y} / \delta_{0y}$. Hence,

$$\theta = \frac{|K_G|}{K_0} = \left| \frac{P\delta_{0y}}{V_{0y}h} \right| \tag{C12.8-1}$$

Given the above, and the geometric relationships shown in Figure C12.8-7, it can be shown that the force producing yield in condition 1 (with P-delta effects) is

$$V_{1y} = V_{0y} (1 - \theta) \tag{C12.8-2}$$

and that for an applied force, V , less than or equal to V_{1y}

$$\delta_1 = \frac{\delta_0}{1 - \theta} \tag{C12.8-3}$$

As θ approaches 1.0, δ_1 approaches infinity and V_1 approaches zero, defining a state of static instability.

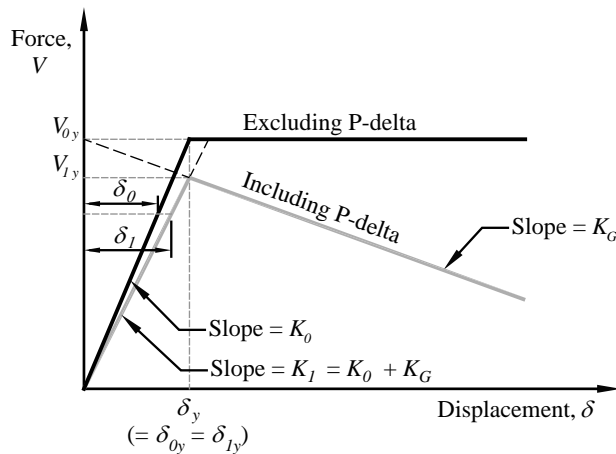

Figure C12.8-7 P-delta effect on a simple structure.

The intent of Section 12.8.7 is to determine whether P-delta effects are significant, and if so, to modify the strength and stiffness of the structure to account for such effects. Also, maximum permitted values of θ are established.

Equation 12.8-16 is used to determine the stability coefficient of each story of a structure. Where the stability coefficient exceeds 0.1, P-delta effects must be considered using one of two approaches. Displacements and member forces are either multiplied by $1/(1-\theta)$ to reflect the conditions shown in Figure C12.8-7 in accordance with the equal displacement rule or determined by rational analysis. Two types of rational analysis are envisioned. First, a nonlinear static (pushover) analysis could be performed to show that the post-yield slope of the pushover curve is continuously positive up to the target displacement. Second, a nonlinear dynamic response history analysis could be repeated with and without P-delta effects to determine if the behavior including P-delta meets all performance criteria.

Although the P-delta procedures in the standard reflect the simple static idealization shown in Figure C12.8-7, the real issue is one of dynamic stability. For that reason, nonlinear response history analysis is appealing. Such analysis should reflect variability of ground motions and system properties, including initial stiffness, strain hardening stiffness, initial strength, hysteretic behavior, and magnitude of gravity load. Unfortunately, the dynamic response of structures is highly sensitive to such parameters, causing considerable dispersion to appear in the results (Vamvatsikos, 2002). This dispersion, which increases dramatically with stability coefficient θ , is due primarily to the incrementally increasing residual deformations (ratcheting) that occur during the response. Residual deformations may be controlled by increasing either the initial strength or the secondary stiffness. See Gupta and Krawinkler (2000) for additional information.

Equation 12.8-17 establishes the maximum stability coefficient permitted. The intent of this requirement is to protect structures from the possibility of stability failures triggered by post-earthquake residual deformation.

C12.9 MODAL RESPONSE SPECTRUM ANALYSIS

In the modal response spectrum analysis method, the structure is decomposed into a number of single-degree-of-freedom systems, each having its own mode shape and natural period of vibration. The number of modes available is equal to the number of mass degrees of freedom of the structure, so the number of modes can be reduced by eliminating mass degrees of freedom. For example, rigid diaphragm constraints may be used to reduce the number of mass degrees of freedom to one per story for planar models, and to three per story (two translations and rotation about the vertical axis) for three-dimensional structures. However, where the vertical elements of the seismic-force-resisting system have significant differences in lateral stiffness, rigid diaphragm models should be used with caution as relatively small in-plane diaphragm deformations can have a significant effect on the distribution of forces.

For a given direction of loading, the displacement in each mode is determined from the corresponding spectral acceleration, modal participation, and mode shape. Because the sign (positive or negative) and the time of occurrence of the maximum acceleration are lost in creating a response spectrum, there is no way to recombine modal responses exactly. However, statistical combination of modal responses produces reasonably accurate estimates of displacements and component forces. The loss of signs for computed quantities leads to problems in interpreting force results where seismic effects are combined with gravity effects, produces forces that are not in equilibrium, and makes it impossible to plot deflected shapes of the structure.

C12.9.1 Number of Modes. The key motivation to perform modal response spectrum analysis is to determine how the actual distribution of mass and stiffness of a structure affects the elastic displacements and component forces. Where at least 90 percent of the model mass participates in the response, the distribution of forces and displacements is sufficient for design. The scaling required by Section 12.9.4 controls the overall magnitude of design values so that incomplete mass participation does not produce unconservative results.

The number of modes required to achieve 90 percent modal mass participation is usually a small fraction of the total number of modes. See Lopez and Cruz (1996) for further discussion of the number of modes to use for modal response spectrum analysis.

C12.9.2 Modal Response Parameters. The design response spectrum (whether the general spectrum from Section 11.4.5 or a site-specific spectrum determined in accordance with Section 21.2) is representative of linear elastic structures. Division of the spectral ordinates by R accounts for inelastic behavior, and multiplication of spectral ordinates by I provides the additional strength needed to improve the performance of important structures. The displacements that are computed using the response spectrum that has been modified by R and I (for strength) must be amplified by C_d and reduced by I to produce the expected inelastic displacements. (See Section C12.8.6.)

C12.9.3 Combined Response Parameters. Most computer programs provide for either the SRSS or the CQC method (Wilson, et al., 1981) of modal combination. The two methods are identical where applied to planar structures, or where zero damping is specified for the computation of the cross-modal coefficients in the CQC method. The modal damping specified in each mode for the CQC method should be equal to the damping level that was used in the development of the response spectrum. For the spectrum in Section 11.4.5, the damping ratio is 0.05.

The SRSS or CQC method is applied to loading in one direction at a time. Where Section 12.5 requires explicit consideration of orthogonal loading effects, the results from one direction of loading may be added to 30 percent of the results from loading in an orthogonal direction. Wilson (2000) suggests that a more accurate approach is to use the SRSS method to combine 100 percent of the results from each of two orthogonal directions where the individual directional results have been combined by SRSS or CQC, as appropriate.

C12.9.4 Scaling Design Values of Combined Response. The modal base shear, V_l , may be less than the ELF base shear, V , because: (a) the calculated fundamental period may be longer than that used in computing V , (b) the response is not characterized by a single mode, and (c) the ELF base shear assumes 100 percent mass participation in the first mode, which is always an overestimate. The scaling required by Section 12.9.4 provides, in effect, a minimum base shear for design. This minimum base shear is provided because the computed period of vibration may be the result of an overly flexible (incorrect) analytical model. The possible 15 percent reduction in design base shear may be considered as an incentive for using a modal response spectrum analysis in lieu of the equivalent lateral force procedure.

Displacements from the modal response spectrum are not scaled because the use of an overly flexible model will result in conservative estimates of displacement that need not be further scaled.

C12.9.5 Horizontal Shear Distribution. Accidental torsion must be included in the analysis as specified in Section 12.8.7. For modal analysis there are two basic approaches to include accidental torsion.

The first approach is to perform static analyses with accidental torsions applied at each level of the structure, and then add these results to those obtained from the modal response spectrum analysis. Where this approach is used, torsional amplification in accordance with Section 12.8.4.3 is required.

The second approach, which applies only to three-dimensional analysis, is to offset the centers of mass of each story 5 percent in each direction, thus requiring four separate models. The advantage of this method is that the effects of direct loading and accidental torsion are combined automatically. A practical disadvantage is the increased bookkeeping for multiple analyses.

Where this approach is used, further amplification of accidental torsion is not required because repositioning the center of mass in a dynamic analysis changes the natural mode shapes and frequencies, producing torsions larger than the static accidental torsion.

C12.9.6 P-delta Effects. The requirements of Section 12.8.7, including the stability coefficient limit, θ_{max} , apply to modal response spectrum analysis.

Amplification of displacements and member forces as a result of P-delta effects may be accomplished through use of the geometric stiffness. For the purpose of dynamic analysis, the linearized geometric stiffness, which includes the story-wise P- Δ effect, is usually sufficient. Using the consistent geometric stiffness (P- δ effect), which is associated with the deflected shape of the individual elements of the structure, slightly improves accuracy. Including P-delta effects directly in dynamic analysis lengthens of the periods of vibration of each mode of response and increases lateral displacements.

C12.10 DIAPHRAGMS, CHORDS, AND COLLECTORS

C12.10.1 Diaphragm Design. Diaphragms are generally treated as horizontal deep beams or trusses that distribute lateral forces to the vertical elements of the seismic-force-resisting system. As deep beams, diaphragms must be designed to resist the resultant shear and bending stresses. Diaphragms are commonly compared to girders, with the roof or floor deck analogous to the girder web in resisting shear, and the boundary elements (chords) analogous to the flanges of the girder in resisting flexural tension and compression. As in girder design, the chord members (flanges) must be sufficiently connected to the body of the diaphragm (web) to prevent separation and to force the diaphragm to work as single unit.

Diaphragms may be considered flexible, semi-rigid, or rigid. The flexibility or rigidity of the diaphragm determines how lateral forces will be distributed to the vertical elements of the seismic-force-resisting system. See Section C12.3.1. Once the distribution of lateral forces is determined, shear and moment diagrams are used to compute the diaphragm shear and chord forces. Where diaphragms are not flexible, inherent and accidental torsion must be considered in accordance with Section 12.8.4.

Diaphragm openings may require additional localized reinforcement (sub-chords and collectors) to resist the subdiaphragm chord forces above and below the opening and to collect shear forces where the diaphragm depth is reduced. (See Figure C12.10-1.) Collectors on each side of the opening drag shear into the subdiaphragms above and below the opening. The subchord and collector reinforcement must extend far enough into the adjacent diaphragm to develop the axial force through shear transfer. The required development length is determined by dividing the axial force in the sub-chord by the shear capacity (in force/unit length) of the main diaphragm.

Chord reinforcement at reentrant corners must extend far enough into the main diaphragm to develop the chord force through shear transfer. (See Figure C12.10-2.) Continuity of the chord members also must be considered where the depth of the diaphragm is not constant.

In wood and metal deck diaphragm design, framing members are often used as continuity elements, serving as sub-chords and collector elements at discontinuities. These continuity members also are often used to transfer wall out-of-plane forces to the main diaphragm, where the diaphragm itself does not have the capacity to resist the anchorage force directly. For additional discussion, see Section C12.11.2.2.3.

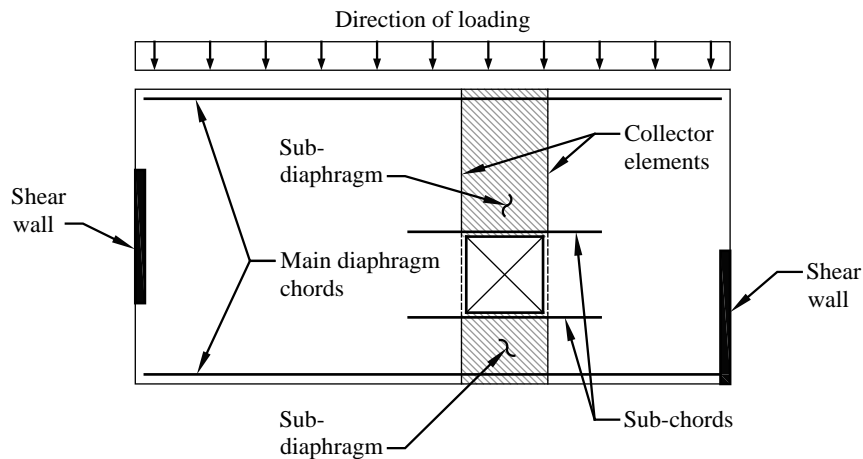

Figure C12.10-1 Diaphragm components.

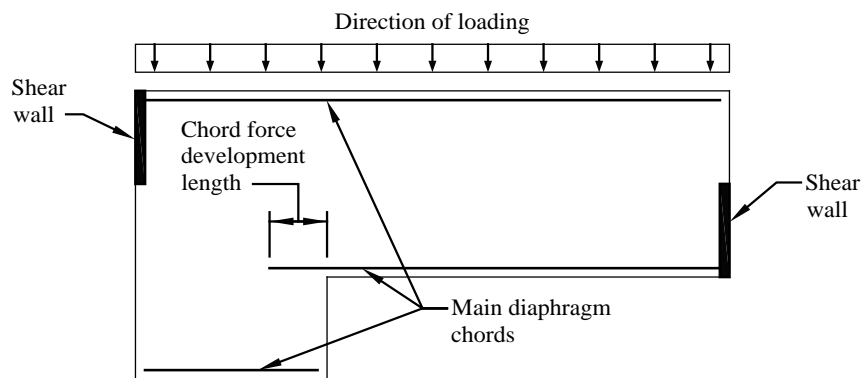

Figure C12.10-2 Diaphragm with a re-entrant corner.

C12.10.1.1 Diaphragm Design Forces. Diaphragms must be designed to resist inertial forces, as specified in Equation 12.10-1, and to transfer design seismic forces due to horizontal offsets or changes in stiffness of the vertical resisting elements. Inertial forces are those seismic forces that originate at the specified diaphragm level, while the transfer forces originate above the specified diaphragm level. The redundancy factor, ρ , used for design of the seismic-force-resisting elements also applies to diaphragm transfer forces, thus completing the load path.

C12.10.2.1 Collector Elements Requiring Load Combinations with Overstrength Factor for Seismic Design Categories C through F. The overstrength requirement of this section is intended to keep inelastic behavior in the ductile elements of the seismic-force-resisting system (consistent with the R factor) rather than in collector elements.

C12.11 STRUCTURAL WALLS AND THEIR ANCHORAGE

As discussed in Section C11.7, structural integrity is important not only in earthquake-resistant design but also in resisting high winds, floods, explosion, progressive failure, and even such ordinary hazards as foundation settlement. The detailed requirements of this section address wall-to-diaphragm integrity.

C12.11.1 Design for Out-of-Plane Forces. Because they are often subjected to local deformations caused by material shrinkage, temperature changes, and foundation movements, wall connections require some degree of ductility in order to accommodate slight movements while providing the required strength.

Although nonstructural walls are not subject to this requirement, they must be designed in accordance with Chapter 13.

C12.11.2 Anchorage of Concrete or Masonry Structural Walls. One major hazard in past earthquakes is the separation of heavy masonry or concrete walls from floors or roofs. The forces defined in this section apply only to the anchorage or connection of the wall to the structure, and not to overall wall design. The anchorage force should be considered both for tension (out-of-plane) and sliding (in-plane) directions.

Where the lateral spacing of connections used to resist the wall anchorage force are spaced further apart than 4 feet (1219 mm) as measured along the length of the wall, the section of wall that spans between the anchors must be designed to resist the local out-of-plane bending caused by this force.

C12.11.2.1 Anchorage of Concrete or Masonry Structural Walls to Flexible Diaphragms. Diaphragm flexibility can amplify out-of-plane accelerations so the wall anchorage forces in this condition are twice those defined in Section 12.11.1.

C12.11.2.2 Additional Requirements for Diaphragms in Structures Assigned to Seismic Design Categories C through F.

C12.11.2.2.1 Transfer of Anchorage Forces into Diaphragm. This requirement, which aims to prevent the diaphragm from tearing apart during strong shaking by requiring transfer of anchorage forces across the complete depth of the diaphragm, was prompted by failures of connections between tilt up concrete walls and wood panelized roof systems in the 1971 San Fernando earthquake. An exception is provided for modestly proportioned diaphragms of light-frame construction, which have not performed poorly.

Depending upon diaphragm shape and member spacing, numerous suitable combinations of subdiaphragms and continuous tie elements and smaller sub-subdiaphragms connecting to larger subdiaphragm and continuous tie elements are possible. The configuration of each subdiaphragm (or sub-subdiaphragm) provided must comply with the simple 2.5-to-1 length-to-width ratio, and the continuous ties must have adequate member and connection strength to carry the accumulated wall anchorage forces.

C12.11.2.2.2 Steel Elements of Structural Wall Anchorage System. A multiplier of 1.4 has been specified for strength design of steel elements in order to obtain a fracture strength of almost 2 times the specified design force (where ϕ_t is 0.75 for tensile rupture).

C12.11.2.2.3 Wood Diaphragms. Material standards for wood structural panel diaphragms permit the sheathing to resist shear forces only; use to resist direct tension or compression forces is not permitted. Therefore, seismic anchorage forces from walls must be transferred into framing members (such as beams, purlins, or subpurlins) using suitable straps or anchors. For wood diaphragms, it is common to use local framing and sheathing elements as subdiaphragms to transfer the uniform lateral wall forces into more concentrated lines of drag or continuity framing that carry the forces across the diaphragm and hold the building together. Figure C12.11-1 shows a schematic plan of typical roof framing using subdiaphragms.

Fasteners to wood framing are intended to transfer shear forces only along the wood framing; any forces acting transverse to the framing tend to induce splitting (due to cross-grain tension). Fasteners into wood ledgers attached to concrete or masonry walls are designed to resist shear forces only; separate straps or anchors generally are provided to transfer out-of-plane wall forces into perpendicular framing members.

C12.11.2.2.4 Metal Deck Diaphragms. In addition to transferring shear forces, metal deck diaphragms often can resist direct axial forces in at least one direction. However, corrugated metal decks cannot transfer axial forces in the direction perpendicular to the corrugations and are prone to buckling if the unbraced length of the deck as a compression element is large. To manage diaphragm forces perpendicular to the deck corrugations, it is common that metal decks are supported at 8- to 10-foot intervals by joists that are connected to walls in a manner suitable to resist the full wall anchorage design force and to carry that force across the diaphragm. In the direction parallel to the deck corrugations, subdiaphragm systems are considered near the walls; if the compression forces in the deck become large relative to the joist spacing, small compression reinforcing elements are provided to transfer the forces into the subdiaphragms.

C12.11.2.2.6 Eccentrically Loaded Anchorage System. Wall anchors often are loaded eccentrically, either because the anchorage mechanism allows eccentricity, or because of anchor bolt or strap misalignment. This eccentricity reduces the anchorage connection capacity and hence must be considered explicitly in design of the anchorage. Figure C12.11-2 shows a one-sided roof-to-wall anchor that is subjected to severe eccentricity due to a misplaced anchor rod. If the detail were designed as a concentric two-sided connection, this condition would be easier to correct.

C12.11.2.2.7 Walls with Pilasters. The anchorage force at pilasters must be calculated considering two-way bending in wall panels. It is customary to anchor the walls to the diaphragms assuming one-way bending and simple supports at the top and bottom of the wall. However, where pilasters are present in the walls, their stiffening effect must be taken into account. Each panel between pilasters is supported on four sides. The reaction at the pilaster top is the result of two-way action of the

panel and is applied directly to the beam or girder anchorage at the top of the pilaster. The anchor load at the pilaster generally is larger than the typical uniformly distributed anchor load between pilasters. Figure C12.11-3 shows the tributary area typically used to determine the anchorage force for a pilaster.

Anchor points adjacent to the pilaster must be designed for the full tributary loading, conservatively ignoring the effect of the adjacent pilaster.

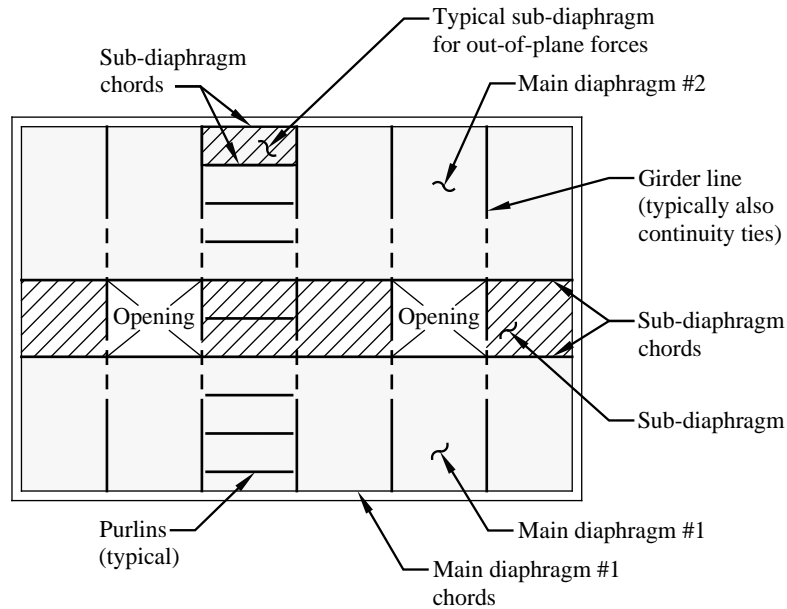

Figure C12.11-1 Typical subdiaphragm framing.

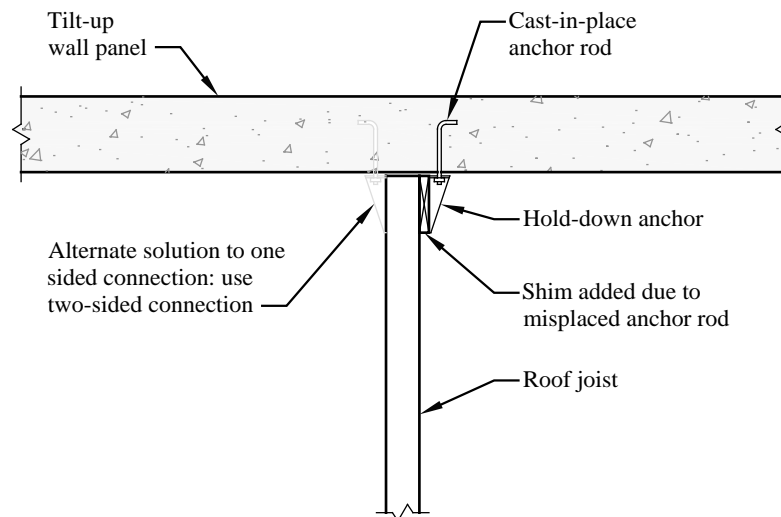

Figure C12.11-2 Plan view of wall anchor with misplaced anchor rod.

C12.12 DRIFT AND DEFORMATION

As used in the standard, deflection is the absolute lateral displacement of any point in a structure relative to its base, and story drift is the difference in deflection across a story (i.e., the deflection of a floor relative to that of the floor below).

The drifts and deflections are checked for the design earthquake ground motion, which is two-thirds of the maximum considered earthquake (MCE) ground motion.

There are many reasons to control drift; the most significant are to address the structural performance concerns of member inelastic strain and system stability and to limit damage of nonstructural components, which can be life-threatening. Drifts provide a direct but imprecise measure of member strain and structural stability. Under small lateral deformations, secondary stresses due to the P-delta effect are normally within tolerable limits. (See Section C12.8.7.) The drift limits provide indirect control of structural performance.

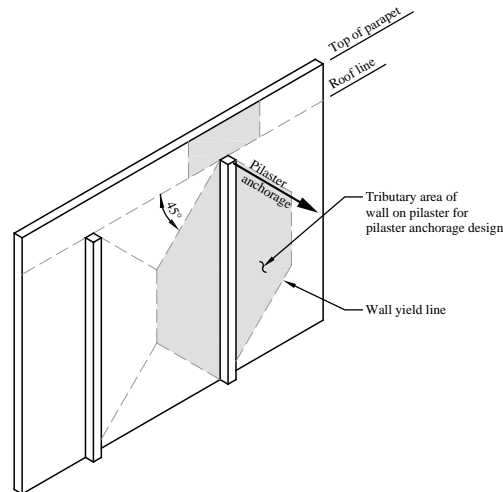

Figure 12.11-3 Tributary area used to determine anchorage force at pilaster.

Buildings subjected to earthquakes need drift control to restrict damage of partitions, shaft and stair enclosures, glass, and other fragile nonstructural elements. The drift limits have been established without regard to economic considerations such as a comparison of present worth of future repairs with additional structural costs to limit drift. These are matters for building owners and designers to address.

The drift limits of Table 12.12-1 reflect consensus judgment taking into account life safety and damage control objectives described above. Since the displacements induced in a structure include inelastic effects, structural damage in the design-level earthquake is likely. This may be seen from the seismic drift limits stated in Table 12.12-1. For ordinary structures (Occupancy Category I or II), the drift limit is $0.02h_{sx}$, which is about ten times the drift ordinarily allowed under wind loads. If deformations well in excess of the seismic drift limits were to occur repeatedly, structural components could lose so much stiffness or strength that they compromise the safety and stability of the structure.

To provide better performance for Occupancy Category IV essential facilities, their drift limits generally are more stringent than those for Occupancy Categories II and III. However, those limits are still greater than the damage thresholds for most nonstructural components. Therefore, while the performance of Occupancy Category IV buildings should be better than that of lower Occupancy Category buildings, there still can be considerable damage in the design earthquake.

The drift limits for low-rise structures are relaxed somewhat, provided that the interior walls, partitions, ceilings, and exterior wall systems have been designed to accommodate story drifts. The type of steel building envisioned by the exception to the table would be similar to a prefabricated steel structure with metal skin.

The limits set forth in Table 12.12-1 are for story drifts and apply to each and every story. For some structures, satisfying strength requirements may produce a system with adequate drift control. However, the design of moment-resisting frames and of tall, narrow shear walls or braced frames often is governed by drift considerations. Where design spectral response accelerations are large, seismic drift considerations are expected to control the design of midrise buildings. Where design spectral response accelerations are small or the building is very tall, design for wind generally will control.

C12.12.3 Building Separation. The intent of this section is to address separations (also called seismic joints) between adjacent structures or portions of the same structure (with or without frangible closures) for the purpose of permitting independent response to earthquake ground motion. For irregular structures that cannot be expected to act reliably as a unit, seismic joints should be used to produce separate units whose independent response to earthquake ground motion can be predicted.

The standard does not give a precise formulation for the separations, but it does require that the distance be “sufficient to avoid damaging contact under total deflection.” It is recommended that the distance be no less than the square root of the sum of the squares of the lateral deflections, which represent the anticipated maximum inelastic deformations including torsion, of the two units assumed to deflect toward each other (thus increasing with height). If the effects of impact can be shown not to be detrimental, these distances can be reduced. For very rigid shear wall structures with rigid diaphragms whose lateral deflections cannot be reasonably estimated, it is suggested that older code requirements for structural separations of at least 1 inch (25 mm) plus 1/2 inch (13 mm) for each 10 feet (3 m) of height above 20 feet (6 m) be followed.

C12.12.4 Deformation Compatibility For Seismic Design Categories D Through F. The purpose of this section is to require that the seismic-force-resisting system provide adequate deformation control to protect elements of the structure that are not part of the seismic-force-resisting system. In regions of high seismicity, many designers apply ductile detailing requirements to elements that are intended to resist seismic forces but neglect such practices in nonstructural elements or elements intended to resist only gravity forces. Even where elements of the structure are not intended to resist seismic forces and are not detailed for such resistance, they can participate in the response and suffer severe damage as a result.

In the 1994 Northridge earthquake, such participation was a cause of several failures. A preliminary reconnaissance report of that earthquake (EERI, 1994) states:

Of much significance is the observation that six of the seven partial collapses (in modern precast concrete parking structures) seem to have been precipitated by damage to the gravity load system. Possibly, the combination of large lateral deformation and vertical load caused crushing in poorly confined columns that were not detailed to be part of the lateral load resisting system. . . . Punching shear failures were observed in some structures at slab-to-column connections such as at the Four Seasons building in Sherman Oaks. The primary lateral load resisting system was a perimeter ductile frame that performed quite well. However, the interior slab-column system was incapable of undergoing the same lateral deflections and experienced punching failures.

This section addresses such concerns. Rather than relying on designers to assume appropriate levels of stiffness, this section explicitly requires that the stiffening effects of adjoining rigid structural and nonstructural elements be considered and that a rational value of member and restraint stiffness be used for the design of components that are not part of the seismic-force-resisting system.

This section also includes a requirement to address shears that can be induced in structural components that are not part of the seismic-force-resisting system, since sudden shear failures have been catastrophic in past earthquakes.

The exception in Section 12.12.4 is intended to encourage the use of intermediate or special detailing in beams and columns that are not part of the seismic-force-resisting system. In return for better detailing, such beams and columns are permitted to be designed to resist moments and shears from unamplified deflections. This reflects observations and experimental evidence that well-detailed components can accommodate large drifts by responding inelastically without losing significant vertical load-carrying capacity.

C12.13 FOUNDATION DESIGN

C12.13.3 Foundation Load-Deformation Characteristics. This section of the standard provides guidance on modeling load-deformation characteristics of the foundation-soil system (foundation stiffness) for linear analysis procedures. The further guidance contained herein addresses both linear and nonlinear analysis methods. Where linear analysis procedures are used with the methodology given below, the earthquake forces should not be reduced by R .

Modeling of the load-deformation characteristics of foundations should be in accordance with ASCE/SEI 41. For nonlinear analysis of piles that may form plastic hinges, the lateral load-deformation characteristics of piles may be taken from Song, et al. (2005).

For load combinations including seismic load effects, the vertical, lateral, and rocking load capacities of foundations as limited by the soil should be sufficient to resist loads with acceptable deformations, considering the short duration of loading, the dynamic properties of the soil, and the ultimate load capacities, Q_{us} , of the foundations.

Ultimate foundation load capacities should be determined by a qualified geotechnical engineer based on geotechnical site investigations that include field and laboratory testing to determine soil classification and soil strength parameters or on in-situ testing of prototype foundations. For competent soils that do not undergo strength degradation under seismic loading, strength parameters for static loading conditions may be used to compute ultimate load capacities for seismic design. For sensitive cohesive soils or saturated cohesionless soils, the potential for earthquake-induced strength degradation should be considered.

Ultimate foundation load capacities, Q_{us} , under vertical, lateral, and rocking loading should be determined using accepted foundation design procedures and principles of plastic analysis. Calculated ultimate load capacities, Q_{us} , should be best-estimated values using soil properties that are representative average values for individual foundations. Best-estimated values of Q_{us} should be reduced by resistance factors (ϕ) to reflect uncertainties in site conditions and in the reliability of analysis methods. The factored foundation load capacity, ϕQ_{us} , should be used both to check acceptance criteria and as the foundation capacity in nonlinear load-deformation models.

If ultimate foundation load capacities are determined based on geotechnical site investigations including laboratory or in-situ tests, ϕ factors equal to 0.8 for cohesive soils and 0.7 for cohesionless soils should be used for vertical, lateral, and rocking resistance for all foundation types. If ultimate foundation load capacities are determined based on full-scale field-testing of prototype foundations, ϕ factors equal to 1.0 for cohesive soils and 0.9 for cohesionless soils are recommended.

For both linear and nonlinear analysis procedures, a model incorporating a combined superstructure and foundation system is necessary to assess the effect of foundation deformations on the superstructure elements.

For linear analysis methods, the linear load-deformation behavior of foundations should be represented by an equivalent linear (secant) stiffness using soil properties that are compatible with the soil strain levels associated with the design earthquake motion. The strain-compatible shear modulus, G , and the associated strain-compatible shear wave velocity, v_s , needed for the evaluation of equivalent linear stiffness are specified in Chapter 19 of the standard or can be based on a site-specific study. ASCE/SEI 41 is an acceptable alternative to that contained in the standard and may provide more realistic results.

For nonlinear analysis procedures, the nonlinear load-deformation behavior of the foundation-soil system may be represented by a bilinear or multilinear curve having an initial equivalent linear stiffness and a limiting foundation capacity. The initial equivalent linear stiffness should be determined as described above for linear analysis methods. The limiting foundation capacity should be taken as the factored foundation load capacity, ϕQ_{us} . Parametric variations in analyses should include: (a) a reduction in stiffness of 50 percent combined with a limiting foundation capacity, ϕQ_{us} , and (b) an increase in stiffness of 50 percent combined with a limiting foundation capacity equal to Q_{us} multiplied by $1/\phi$.

For linear analysis procedures, factored foundation load capacities, ϕQ_{us} , should not be exceeded for load combinations that include seismic load effects.

For the nonlinear analysis procedures, if the factored foundation load capacity, ϕQ_{us} , is reached during seismic loading, the potential significance of associated transient and permanent foundation displacements should be evaluated. Foundation displacements are acceptable if they do not impair the continuing function of Occupancy Category IV structures or the life safety of any structure.

C12.13.4 Reduction of Foundation Overturning. Since the vertical distribution of forces prescribed for use with the equivalent lateral force procedure is intended to envelope story shears, overturning moments are exaggerated. (See Section C12.13.3.) Such moments will be lower where multiple modes respond, so a 25 percent reduction is permitted for design (strength and stability) of the foundation using this procedure. This reduction is not permitted for inverted pendulum or cantilevered column type structures, which typically have a single mode of response.

Since the modal response spectrum analysis procedure more accurately reflects the actual distribution of shears and overturning moments, the permitted reduction is only 10 percent.

C12.13.5 Requirements for Structures Assigned to Seismic Design Category C.

C12.13.5.1 Pole-Type Structures. The high contact pressures that develop between pole and soil as a result of lateral loads make pole-type structures sensitive to earthquake motions. Bending in the poles and soil lateral capacity and deformation are key considerations in the design. For further discussion of pole-soil interaction, see Section C12.13.6.7.

C12.13.5.2 Foundation Ties. One important aspect of adequate seismic performance is that the foundation acts as a unit, not permitting one column or wall to move appreciably with respect to another. To attain this performance, it is common to provide ties between footings and pile caps. This is especially important where the use of deep foundations is driven by the existence of soft surface soils.

Multistory buildings often have major columns that run the full height of the building adjacent to smaller columns that support only one level; the calculated tie force is based on the heavier column load.

The standard permits alternate methods of tying foundations together. Lateral soil pressure on pile caps is not a recommended method because motion is imparted from soil to structure and during displacement under dynamic conditions.

C12.13.5.3 Pile Anchorage Requirements. The pile anchorage requirements are intended to prevent brittle failures of the connection to the pile cap under moderate ground motions. Moderate ground motions can result in pile tension forces or bending moments that could compromise shallow anchorage embedment. Loss of pile anchorage could result in increased structural displacements from rocking, overturning instability, and loss of shearing resistance at the ground surface. A concrete bond to a bare steel pile section usually is unreliable, but connection by means of deformed bars properly developed from the pile cap into concrete confined by a circular pile section is permitted.

C12.13.6 Requirements for Structures Assigned to Seismic Design Categories D through F.

C12.13.6.1 Pole-Type Structures. See Section C12.13.5.1.

C12.13.6.2 Foundation Ties. See Section C12.13.5.2. For Seismic Design Categories D through F, the requirement is extended to spread footings on soft soils.

C12.13.6.3 General Pile Design Requirements. Design of piles is based on the same R factor used in design of the superstructure; since inelastic behavior will result, piles should be designed with ductility similar to that of the superstructure. When strong ground motions occur, inertial structure pile-soil interaction may produce plastic hinging in piles near the bottom of the pile cap, and kinematic soil-pile interaction will result in bending moments and shearing forces throughout the length of the pile, being higher at interfaces between stiff and soft soil strata. These effects are particularly severe in soft soils and liquefiable soils so Section 14.2.3.2.1 requires special detailing in areas of concern.

The shears and curvatures in piles caused by inertial and kinematic interaction may exceed the bending capacity of conventionally designed piles, resulting in severe damage. Analysis techniques to evaluate pile bending are discussed by Margason and Holloway (1977) and Mylonakis (2001), and these effects on concrete piles are further discussed by Shepard (1983). For homogeneous, elastic media and assuming the pile follows the soil, the free-field curvature (soil strains without a pile present) can be estimated by dividing the peak ground acceleration by the square of the shear wave velocity of the soil; considerable judgment is necessary in using this simple relationship for a layered, inelastic profile with pile-soil interaction effects. Norris (1994) discusses methods to assess pile-soil interaction.

Where determining the extent of special detailing, the designer must consider variation in soil conditions and driven pile lengths, so that adequate ductility is provided at potential high curvature interfaces. Confinement of concrete piles to provide ductility and to maintain functionality of the confined core pile during and after the earthquake may be obtained by use of heavy spiral reinforcement or use of exterior steel liners.

C12.13.6.4 Batter Piles. Partially embedded batter piles have a history of poor performance in strong ground shaking, as shown by Gerwick and Fotinos (1992). Failure of battered piles has been attributed to design that neglect loading on the piles from ground deformation or that assumes that lateral loads are resisted by axial response of piles without regard to moments induced in the pile at the pile cap (Lam and Bertero, 1990). Because batter piles are considered to have limited ductility, they must be designed using the load combinations with overstrength. Moment-resisting connections between pile and pile cap must resolve the eccentricities inherent in batter pile configurations. This concept is illustrated clearly by EQE Engineering (1991).

C12.13.6.5 Pile Anchorage Requirements. Piles should be anchored to the pile cap to permit energy dissipating mechanisms, such as pile slip at the pile-soil interface, while maintaining a competent connection. This section of the standard sets forth a capacity design approach to achieve that objective. Anchorages occurring at pile cap corners and edges should be reinforced to preclude local failure of plain concrete sections due to pile shears, axial loads, and moments.

C12.13.6.6 Splices of Pile Segments. A capacity design approach, similar to that for pile anchorage, is applied to pile splices.

C12.13.6.7 Pile Soil Interaction. Short piles and long slender piles embedded in the earth behave differently when subject to lateral forces and displacements. The response of a long slender pile depends on its interaction with the soil considering the nonlinear response of the soil. Numerous design aid curves and computer programs are available for this type of analysis, which is necessary to obtain realistic pile moments, forces, and deflections and is common in practice (Ensoft, 2004). More sophisticated models, which also consider inelastic behavior of the pile itself, can be analyzed using general-purpose nonlinear analysis computer programs or closely approximated using the pile-soil limit state methodology and procedure given by Song, et al. (2005).

Short piles (with length-to-diameter ratios no more than 6) can be treated as a rigid body simplifying the analysis. A method assuming a rigid body and linear soil response for lateral bearing is given in the current building codes. A more accurate and comprehensive approach using this method is given in a study by Czerniak (1957).

C12.13.6.8 Pile Group Effects. The effects of groups of piles, where closely spaced, must be taken into account for vertical and horizontal response. As groups of closely spaced piles move laterally, failure zones for individual piles overlap, and horizontal strength and stiffness response of the pile-soil system is reduced. Reduction factors or “ p -multipliers” are used to account for these groups of closely spaced piles. For a pile center-to-center spacing of three pile diameters, reduction factors of 0.6 for the leading pile row and 0.4 for the trailing pile rows are recommended by Rollins, et al. (1999). Computer programs are available to analyze group effects assuming a nonlinear soil and elastic piles (Ensoft, 2004a).

C12.14 SIMPLIFIED ALTERNATIVE STRUCTURAL DESIGN CRITERIA FOR SIMPLE BEARING WALL OR BUILDING FRAME SYSTEMS

C12.14.1 General. In recent years, engineers and building officials have become concerned that the seismic design requirements in codes and standards, while intended to make structures perform more reliably, have become so complex and difficult to understand and to implement that they may be counterproductive. Since the response of buildings to earthquake ground shaking is very complex (especially for irregular structural systems), realistically accounting for these effects can lead to complex requirements. There is a concern that the typical designers of small, simple structures, which may represent more than 90 percent of construction in the United States, have difficulty understanding and applying the general seismic requirements of the standard.

The simplified procedure presented in this section of the standard applies to low-rise, stiff structures. The procedure, which was refined and tested over a five-year period, was developed to be used for a defined set of structures deemed to be sufficiently regular in configuration to allow a reduction of prescriptive requirements. For some design elements, such as foundations and anchorage of nonstructural systems, other sections of the standard must be followed, as referenced within Section 12.14.

C12.14.1.1 Simplified Design Procedure. Reasons for the limitations of the simplified design procedure of Section 12.14 are as follows:

1. The procedure was developed to address adequate seismic performance for standard occupancies. Since it was not developed for higher levels of performance associated with Occupancy Category III and IV structures, no importance factor (I) is employed.
2. Site Class E and F soils require specialized procedures that are beyond the scope of the procedure.
3. The procedure was developed for stiff, low-rise buildings, where higher-mode effects are negligible.
4. Only stiff systems, where drift is not a controlling design criterion, may employ the procedure. Because of this limitation, drifts are not computed. The response modification coefficient, R , and the associated system limitations are consistent with those found in the general Chapter 12 requirements.
5. In order to achieve a balanced design and to achieve a reasonable level of redundancy, two lines of resistance are required in each of the two major axis directions. Because of this stipulation, no redundancy factor (ρ) is applied.
6. To reduce the potential for dominant torsional response, at least one line of resistance must be placed on each side of the center of mass.
7. Large overhangs for flexible diaphragm buildings can produce response that is inconsistent with the assumptions associated with the procedure.
8. A system that satisfies these layout and proportioning requirements avoids torsional irregularity, so calculation of accidental torsional moments is not required.
9. An essentially orthogonal orientation of lines of resistance effectively uncouples response along the two major axis directions, so orthogonal effects may be neglected.
10. Where the simplified design procedure is chosen, it must be used for the entire design, in both major axis directions.
11. Since in-plane and out-of-plane offsets generally create large diaphragm, collector, and discontinuous element demands that are not addressed by the procedure, these irregularities are prohibited.
12. Buildings that exhibit weak-story behavior violate the assumptions used to develop the procedure.

C12.14.3 Seismic Load Effects and Combinations. The seismic load effect and combination equations for the simplified design procedure are consistent with those for the general procedure, with one notable exception: the overstrength factor (corresponding to Ω_0 in the general procedure) is set at 2.5 for all systems as indicated in Section 12.14.3.2.1. Given the limited systems that can use the simplified design procedure, specifying unique overstrength factors was deemed unnecessary.

C12.14.7 Design and Detailing Requirements. The design and detailing requirements outlined in this section are similar to those for the general procedure. The few differences include the following:

1. Forces used to connect smaller portions of a structure to the remainder of the structures are taken as 0.20 times the short-period design spectral response acceleration, S_{DS} , rather than the general procedure value of 0.133 (Section 12.14.7.1).
2. Anchorage forces for concrete or masonry structural walls for structures with diaphragms that are not flexible are computed using the requirements for nonstructural walls.

C12.14.8 Simplified Lateral Force Analysis Procedure

C12.14.8.1 Seismic Base Shear. The seismic base shear in the simplified design procedure, as given by Equation 12.14-11, is a function of the short-period design spectral response acceleration, S_{DS} . The value for F in the base shear equation addresses changes in dynamic response for two- and three-story buildings. As in the general procedure (Section 12.8.1.3), S_{DS} may be computed for short, regular structures with S_s taken no greater than 1.5.

C12.14.8.2 Vertical Distribution. The seismic forces for multistory buildings are distributed vertically in proportion to the weight of the respective floor. Given the slightly amplified base shear for multi-story buildings, this assumption, along with the three-story height limit, produces results consistent with the more traditional triangular distribution without introducing that more sophisticated approach.

C12.14.8.5 Drift Limits and Building Separation. For the simplified design procedure, which is restricted to stiff wall and braced frame structures, drift need not be calculated. Where drifts are required (such as for structural separations and cladding design) a conservative drift value of 1 percent is specified.

REFERENCES

- American Society of Civil Engineers. 2006. *Seismic Rehabilitation of Existing Buildings*, ASCE/SEI 41. ASCE, Reston, Virginia.
- Applied Technology Council. 2009. *Quantification of Building Seismic Performance Factors*, FEMA P-695. Federal Emergency Management Agency, Washington, D.C.
- Applied Technology Council. 1978. *Tentative Provisions for the Development of Seismic Regulations for Buildings*, ATC 3-06. ATC, Redwood City, California.
- Bernal, D. 1987. "Amplification Factors for Inelastic Dynamic P-delta Effects in Earthquake Analysis," *Earthquake Engineering and Structural Dynamics*, 18: 635-681.
- Building Seismic Safety Council. 2004. *NEHRP Recommended Provisions for Seismic Regulations for New Buildings and Other Structures*, FEMA 450. Federal Emergency Management Agency, Washington, D.C.
- Charney, F. A. 1990. "Wind Drift Serviceability Limit State Design of Multistory Buildings," *Journal of Wind Engineering and Industrial Aerodynamics*, 36:203-212.
- Charney, F. A., and J. Marshall. 2006. "A Comparison of the Krawinkler and Scissors Models for Including Beam-Column Joint Deformations in the Analysis of Moment-Resisting Frames," *AISC Engineering Journal*, 43(1):31-48.
- Chopra, A. K. 2007. *Structural Dynamics*. Prentice Hall.
- Chopra, A. K., and R. K. Goel. 1991. "Evaluation of torsional provisions in seismic codes," *Journal of Structural Engineering*, 117(12):3762-3782
- Chopra, A. K., and N. M. Newmark. 1980. "Analysis," Chapter 2 of *Design of Earthquake Resistant Structures*, edited by E. Rosenblueth. John Wiley and Sons.
- Czerniak, E. 1957. "Resistance to Overturning of Single Short Piles" *ASCE Journal of the Structural Division*, 83(ST-2).
- Degenkolb, Henry J. 1987. "A Study of the P-delta Effect," *Earthquake Spectra*, 3(1).
- De La Liera, J. C., and A. K. Chopra. 1994. "Evaluation of Code Accidental Torsion Records from Building Records," *Journal of Structural Engineering*, 120(2):697-616.
- EQE Engineering. 1991. *Structural Concepts and Details for Seismic Design*, UCRL-CR-106554. Department of Energy, Washington, D.C.

- Ensoft, Inc. 2004a. Computer Program GROUP, Version 6.0, A Program for the Analysis of a Group of Piles Subjected to Axial and Lateral Loading, User's Manual and Technical Manual. Ensoft, Austin, Texas.
- Ensoft, Inc. 2004b. Computer Program LPILE Plus Version 5.0, A Program for the Analysis of Piles and Drilled Shafts under Lateral Loads, User's Manual and Technical Manual. Ensoft, Austin, Texas.
- Gerwick, Jr., B., and G. Fotinos. 1992. "Drilled Piers and Driven Piles for Foundations in Areas of High Seismicity," SEAONC Fall Seminar, October 29, San Francisco, California.
- Griffis, Larry. 1993. "Serviceability Limit States Under Wind Load," *Engineering Journal, American Institute of Steel Construction*, First Quarter.
- Gupta, A., and H. Krawinkler. 2000. "Dynamic P-delta Effects for Flexible Inelastic Steel Structures," *Journal of Structural Engineering*, 126(1):145-154.
- Lam, I., and V. Bertero. 1990. "Aseismic Design of Pile Foundations for Port Facilities," in *Proceedings of the POLA Seismic Workshop on Seismic Engineering*, March 21-23, San Pedro, California, Port of Los Angeles.
- Liew, J. Y. 2001. "Inelastic Analysis of Steel Frames with Composite Beams," *Journal of Structural Engineering*, 127(2):194-202.
- Lopez, O. A., and M. Cruz. 1996. "Number of Modes for the Seismic Design of Buildings," *Earthquake Engineering and Structural Dynamics*, 25(8):837-856.
- Margason, E., and M. Holloway. 1977. "Pile Bending During Earthquakes," in *Proceedings of the 6th World Conference on Earthquake Engineering*, New Delhi.
- Mylonakis, G. 2001. "Seismic pile bending at soil-layer interfaces," *Soils and Foundations*, 41 (4), pp. 47-58.
- Newmark, N. A., and E. Rosenbleuth. 1971. *Fundamentals of Earthquake Engineering*. Prentice Hall.
- Norris, G. M. 1994. "Seismic Bridge Pile Foundation Behavior," in *Proceedings, International Conference on Design and Construction of Deep Foundations*, Federal Highway Administration, Vol. 1.
- Paulay, T. 1997. "Are Existing Seismic Torsion Provisions Achieving Design Aims?" *Earthquake Spectra*, 13(2):259-280.
- Paulay, T., and M. J. N. Priestly. 1992. *Seismic Design of Reinforced Concrete and Masonry Structures*. John Wiley and Sons.
- Rollins, Kyle M., K. T. Peterson, T. J. Weaver, and Andrew E. Sparks. 1999. "Static and dynamic lateral load behavior on a full-scale pile group in clay," Brigham Young University, Provo, Utah, and the Utah Department of Transportation, Salt Lake City, June 23.
- Schaffhausen, R., and A. Wegmuller. 1977. "Multistory Rigid Frames with Composite Girders under Gravity and Lateral Forces," *AISC Engineering Journal*, 2nd Quarter.
- Seismology Committee, Structural Engineers Association of California. 1996. *Recommended Lateral Force Requirements and Commentary*. SEAOC, Sacramento, California.
- Shepard, D. A. 1983. "Seismic Design of Concrete Piling," *PCI Journal* (March/April).
- Song, S. T., Y. H. Chai, and T. H. Hale. 2005. "Analytical model for ductility assessment of fixed-head concrete piles," *ASCE Journal of Structural Engineering* 131(7):1051-1059.
- Vamvatsikos, D. 2002. "Seismic Performance, Capacity and Reliability of Structures as Seen Through Incremental Dynamic Analysis," Ph.D. Dissertation, Department of Civil and Environmental Engineering, Stanford University, Palo Alto, California.
- Wilson, E. L., A. Der Kiureghian, and E. P. Bayo. 1981. "A Replacement for the SRSS Method in Seismic Analysis," *Earthquake Engineering and Structural Dynamics*, Vol. 9.
- Wilson, E. L. 2000. *Three-dimensional Static and Dynamic Analysis of Structures*, Computers and Structures, Inc., Berkeley, California.

COMMENTARY CHAPTER 13, SEISMIC DESIGN REQUIREMENTS FOR NONSTRUCTURAL COMPONENTS

C13.1 GENERAL

Chapter 13 defines minimum design criteria for architectural, mechanical, electrical, and other nonstructural systems and components recognizing structure use, occupant load, the need for operational continuity, and the interrelation of structural and architectural, mechanical, electrical, and other nonstructural components. Nonstructural components are designed for design earthquake ground motions as defined in Section 11.2 and determined in Section 11.4.4 of the standard. In contrast to structures, which are implicitly designed for a low probability of collapse when subjected to the maximum considered earthquake (MCE) ground motions, there are no implicit performance goals associated with the MCE for nonstructural components. Performance goals associated with the design earthquake are discussed in Section C13.1.3.

Suspended or attached nonstructural components that could detach either in full or in part from the structure during an earthquake are referred to as falling hazards and may represent a serious threat to property and life safety. Critical attributes that influence the hazards posed by these components include their weight, their attachment to the structure, their failure or breakage characteristics (e.g., certain types of glass), and their location relative to occupied areas (e.g., over an entry or exit, a public walkway, an atrium, or a lower adjacent structure). Architectural components that pose potential falling hazards include parapets, cornices, canopies, marquees, glass, large ornamental elements (e.g., chandeliers), and building cladding. In addition, suspended mechanical and electrical components (e.g., mixing boxes, piping, and ductwork) may represent serious falling hazards. Figures C13.1-1 through C13.1-4 show damage to nonstructural components in past earthquakes.

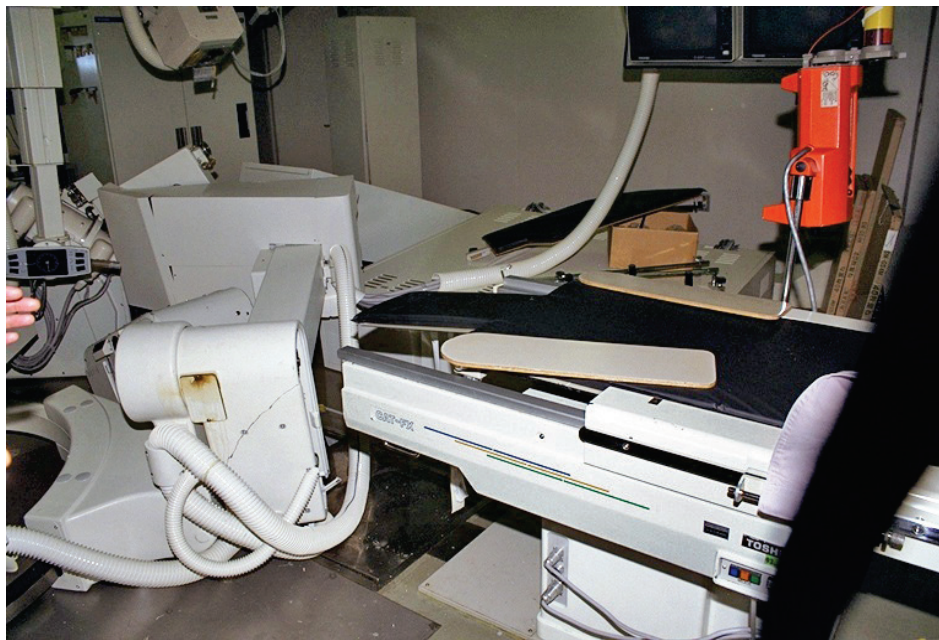

Figure C13.1-1 Hospital imaging equipment that fell from overhead mounts.



Figure C13.1-2 Collapsed light fixtures.



Figure C13.1-3 Collapsed duct and HVAC diffuser.



Figure C13.1-4 Damaged ceiling system.

Components whose collapse during an earthquake could result in blockage of the means of egress deserve special consideration. The term “means of egress” is used commonly in building codes with respect to fire hazard. Consideration of egress may include intervening aisles, doors, doorways, gates, corridors, exterior exit balconies, ramps, stairways, pressurized enclosures, horizontal exits, exit passageways, exit courts, and yards. Items whose failure could jeopardize the means of egress include walls around stairs and corridors, veneers, cornices, canopies, heavy partition systems, ceilings, architectural soffits, light fixtures, and other ornaments above building exits or near fire escapes. Examples of components that generally do not pose a significant falling hazard include fabric awnings and canopies. Architectural, mechanical, and electrical components that, if separated from the structure, will fall in areas that are not accessible to the public (e.g., into a mechanical shaft or light well) also pose little risk to egress routes.

For some architectural components such as exterior cladding elements, wind design forces may exceed the calculated seismic design forces. Nevertheless, seismic detailing requirements may still govern the overall structural design. Where this is a possibility, it must be investigated early in the structural design process.

The seismic design of nonstructural components may involve consideration of nonseismic requirements that are affected by seismic bracing. For example, accommodation of thermal expansion in pressure piping systems often is a critical design consideration and seismic bracing for these systems must be arranged in a manner that accommodates thermal movements. Particularly in the case of mechanical and electrical systems, the design for seismic loads should not compromise the functionality, durability, or safety of the overall design; this requires collaboration between the various disciplines of the design and construction team.

For various reasons (e.g., business continuity), it may be desirable to consider higher performance than that required by the building code. For example, to achieve continued operability of a piping system, it is necessary to prevent unintended operation of valves or other inline components in addition to preventing collapse and providing leak tightness. Higher performance also is required for components containing substantial quantities of hazardous contents (as defined in Section 11.2). These components must be designed to prevent uncontrolled release of those materials.

The requirements of Chapter 13 are intended to apply to new construction and tenant improvements installed at any time during the life of the structure, provided they are listed in Table 13.5-1 or 13.6-1. Further, they are intended to reduce (not eliminate) the risk to occupants and to improve the likelihood that essential facilities remain functional. While property protection (in the sense of investment preservation) is a possible consequence of implementation of the standard, it is not currently a stated or implied goal; a higher level of protection may be advisable if such protection is desired or required.

C13.1.1 Scope. The requirements for seismic design of nonstructural components apply to the nonstructural component as well as to its supports and attachments to the main structure. In some cases as defined in Section 13.2, it is necessary to consider explicitly the performance characteristics of the component. The requirements are intended to apply only to

permanently attached components – not to furnishings, temporary items, or mobile units. Furnishings such as tables, chairs, and desks may shift during strong ground shaking but generally pose minimal hazards provided they do not obstruct emergency egress routes. Storage cabinets, tall bookshelves, and other items of significant mass do not fall into this category and should be anchored or braced in accordance with this chapter.



Figure C13.1-5 Toppled storage cabinets.

Temporary items are those that remain in place for short periods of time (months, not years). Components that, while movable or relocatable, are expected to remain in place for periods of a year or longer should be considered permanent for the purposes of this section. Modular office systems are considered permanent since they ordinarily remain in place for long periods. In addition, they often include storage units of significant capacity which may topple in an earthquake. They are subject to the provisions of Section 13.5.8 for partitions if they exceed 6 feet in height. Mobile units include components that are moved from one point in the structure to another during ordinary use. Examples include desktop computers, office equipment, and other components that are not permanently attached to the building utility systems (Figure C13.1-5). Components that are mounted on wheels to facilitate periodic maintenance or cleaning but that otherwise remain in the same location (e.g., server racks) are not considered moveable for the purposes of anchorage and bracing. Likewise, skid-mounted components (as shown in Figure C13.1-6) as well as the skids themselves are considered permanent equipment.

In all cases, equipment must be anchored if it is permanently attached to utility services (electricity, gas, and water). For the purposes of this requirement, “permanently attached” should be understood to include all electrical connections except NEMA 5-15 and 5-20 straight-blade connectors (duplex receptacles).

C13.1.2 Seismic Design Category. The requirements for nonstructural components are based in part on the Seismic Design Category to which they are assigned. As the Seismic Design Category is established considering factors not unique to specific nonstructural components, all nonstructural components occupying or attached to a structure are assigned to the same Seismic Design Category as the structure.

C13.1.3 Component Importance Factor. Performance expectations for nonstructural components often are defined in terms of the functional requirements of the structure to which the components are attached. While specific performance goals for nonstructural components have yet to be defined in building codes, the component importance factor (I_p) implies performance levels for specific cases. For noncritical nonstructural components (those with an importance factor, I_p , of 1.0) the following behaviors are anticipated for shaking having different levels of intensity:

1. Minor earthquake ground motions – minimal damage; not likely to affect functionality
2. Moderate earthquake ground motions – some damage that may affect functionality
3. Design earthquake ground motions – major damage but significant falling hazards are avoided; likely loss of functionality.



Figure C13.1-6 Skid-mounted components.

Components with importance factors greater than 1.0 are expected to remain in place, sustain limited damage, and, when necessary, function following an earthquake (see Section C13.2.2). These components can be located in structures that are not assigned to Occupancy Category IV. For example, fire sprinkler piping systems have an importance factor, I_p , of 1.5 in all structures since these essential systems should function following an earthquake.

The component importance factor is intended to represent the greater of the life-safety importance of the component and the hazard-exposure importance of the structure. It indirectly influences the survivability of the component via required design forces and displacement levels as well as component attachments and detailing. While this approach provides some degree of confidence in the seismic performance of a component, it may not be sufficient in all cases. For example, individual ceiling tiles may fall from a ceiling grid that has been designed for larger forces. This may not represent a serious falling hazard if the ceiling tiles are made of lightweight materials, but it may lead to blockage of critical egress paths or disruption of the facility function. When higher levels of confidence in performance are required, the component is classified as a designated seismic system (Section 11.2), and, in certain cases, seismic qualification of the component or system is necessary. Seismic qualification approaches are provided in Sections 13.2.5 and 13.2.6. In addition, seismic qualification approaches presently in use by the Department of Energy (DOE) can be applied.

Occupancy Category IV structures are intended to be functional following a design earthquake; critical nonstructural components and equipment in such structures are designed with I_p equal to 1.5. This requirement applies to most components and equipment since damage to vulnerable unbraced systems or equipment may disrupt operations following an earthquake even if they are not directly classified as essential to life safety. The nonessential/nonhazardous components themselves are not assessed, and requirements focus solely on the supports and attachments. UFC 3-310-04 has additional guidance for improved performance.

C13.1.4 Exemptions. Some nonstructural components either possess inherent strength and stability, are subject to low-level earthquake demands (accelerations and relative displacements), or both. Since these nonstructural components and systems are expected to achieve the performance goals described earlier in this commentary without explicitly satisfying additional requirements, they are exempt from the requirements of Chapter 13.

Chapter 13 does not apply to Seismic Design Category A due to its very low level of seismic hazard. (See Section C11.7.) With the exception of parapets supported by bearing walls or shear walls, all components in Seismic Design Category B are exempt due to the minimal level of seismic risk. Parapets are not exempt because experience has shown these items can fail and pose a significant falling hazard even at low shaking levels.

Mechanical and electrical components in Seismic Design Category C with an importance factor (I_p) equal to 1.0 are exempt because they are subject to low levels of seismic hazard, they do not contain hazardous substances, and their function is not required to maintain life safety following an earthquake. Small components with I_p equal to 1.0 in Seismic Design Categories D, E, and F also are exempt since they do not contain hazardous substances and are not large enough to pose a life-safety hazard if they fall, slide, or topple. Failures of unbraced distribution systems at or near the point of connection to nonstructural components have been observed in past earthquakes. For this reason, flexible connections such as expansion loops, braided hose, or expansion joints are required to allow for the larger relative displacements associated with unbraced components. Note that the stiffness of flexible connections may be sensitive to internal pressure and length of the connection.

C13.1.5 Applicability of Nonstructural Component and Requirements. At times, a nonstructural component should be treated as a nonbuilding structure. When the physical characteristics associated with a given class of nonstructural components vary widely, judgment is needed to select the appropriate design procedure and coefficients. For example, cooling towers vary from small packaged units with an operating weight of 2,000 pounds or less to structures the size of buildings. Consequently, design coefficients for the design of “cooling towers” are found both in Table 13.6-1 and Table 15.4-2. Small cooling towers are best designed as nonstructural components using the provisions of Chapter 13 while large ones are clearly nonbuilding structures that are more appropriately designed using the provisions of Chapter 15. Similar issues arise for other classes of nonstructural component (e.g., boilers and bins). Guidance on determining whether an item should be treated as a nonbuilding structure or nonstructural component for the purpose of seismic design is provided in Bachman and Dowty (2008).

There are practical limits on the size of a component that can be qualified via shake table testing. Components too large to be qualified by shake table testing need to be qualified by a combination of structural analysis and qualification testing or empirical evaluation through a subsystem approach. Subsystems of a large, complex component (e.g., a very large chiller) can be qualified individually and the overall structural frame of the component evaluated by structural analysis

Premanufactured modular mechanical units are considered nonbuilding structures supporting nonstructural components. The entire system (all modules assembled) can be shake table qualified or qualified separately as subsystems. Modular mechanical units house various nonstructural components that are subject to all the design requirements of Chapter 13.

The specified weight limit for nonstructural components (25 percent relative to the combined weight of the structure and component) relates to the condition at which dynamic interaction between the component and the supporting structural system is potentially significant. Section 15.3.2 contains requirements for addressing this interaction in design.

C13.1.6 Reference Documents. Professional and trade organizations have developed nationally recognized codes and standards for the design and construction of specific mechanical and electrical components. These documents provide design guidance for normal and upset (abnormal) operating conditions and for various environmental conditions. Some of these documents include earthquake design requirements in the context of the overall mechanical or electrical design. It is the intent of the standard that seismic requirements in referenced documents be used. The developers of these documents are familiar with the expected performance and failure modes of the components; however, the documents may be based on design considerations not immediately obvious to a structural design professional. For example, in the design of industrial piping, stresses due to seismic inertia forces typically are not added to those due to thermal expansion.

There is a potential for misunderstanding and misapplication of reference documents for the design of mechanical and electrical systems. A registered design professional familiar with both the standard and the reference documents used should be involved in the review and acceptance of the seismic design.

Even when reference documents for nonstructural components lack specific earthquake design requirements, mechanical and electrical equipment constructed in accordance with industry-standard reference documents have performed well historically when properly anchored. Nevertheless, it is expected that manufacturers of mechanical and electrical equipment will consider seismic loads in the design of the equipment itself even when not explicitly required by this chapter.

While some reference documents provide requirements for seismic capacity appropriate to the component being designed, the seismic demands used in design may not be less than those specified in the standard.

Specific guidance for selected mechanical and electrical components and conditions is provided in Section 13.6.

C13.1.7 Reference Documents Using Allowable Stress Design. Many nonstructural components are designed using specifically developed reference documents that are based on allowable stress loads and load combinations and permit increases in allowable stresses for seismic loading. Although Section 2.4.1 of the standard does not permit increases in allowable stresses, Section 13.1.7 explicitly defines the conditions for their use in the design of nonstructural components.

C13.2 GENERAL DESIGN REQUIREMENTS

C13.2.1 Applicable Requirements for Architectural, Mechanical, and Electrical Components, Supports, and Attachments. Compliance with the requirements of Chapter 13 may be accomplished by project-specific design or by a manufacturer's certification of seismic qualification of a system or component. In each case, the evidence of compliance is submitted to the authority having jurisdiction. When compliance is by manufacturer's certification, the items must be installed in accordance with the manufacturer's requirements.

Components addressed by the standard include individual simple units and assemblies of simple units for which reference documents establish seismic analysis or qualification requirements. Also addressed by the standard are complex architectural, mechanical, and electrical systems for which reference documents either do not exist or exist for only elements of the system. In the design and analysis of both simple components and complex systems, the concepts of flexibility and ruggedness often can assist the designer in determining the necessity for analysis and, when analysis is necessary, the extent and methods by which seismic adequacy may be determined. These concepts are discussed in Section C13.6.1.

C13.2.2 Special Certification Requirements for Designated Seismic Systems. While the goal of design for most nonstructural components is to prevent detachment or toppling that would pose a hazard to life safety, designated seismic systems (with $I_p = 1.5$) are intended to meet higher performance goals. In some cases, failure of mechanical or electrical equipment itself poses a significant hazard. This section addresses the design and certification of designated seismic system components and their supports and attachments. The goals of this section are to improve survivability and achieve a high level of confidence in post-earthquake functionality, and they require additional considerations.

Examples of designated seismic systems include fire protection piping, uninterruptible power supplies for hospitals, and certain vessels or piping that contain highly toxic or explosive substances.

Using an importance factor, I_p , equal to 1.5 to increase design forces can reduce the possibility of detachment or toppling, but this directly affects only structural integrity and stability; function and operability of mechanical and electrical components may be affected only indirectly by increasing design forces. For complex components, testing or experience may be the only reasonable way to improve the confidence of function and operability. For many types of equipment, past earthquake experience has shown that maintaining structural integrity and stability provides post-earthquake function and operability. On the other hand, mechanical joints in containment components (e.g., tanks, vessels, and piping) may not remain leak-tight in an earthquake. Avoiding this condition may require a design that is more conservative than that required by the standard.

Evaluating post-earthquake operational performance by analysis is impractical for active mechanical and electrical equipment with components that rotate or otherwise move mechanically during operation. Active equipment includes pumps and electric motors. In many cases, such equipment is inherently rugged, and an evaluation of experience data together with analysis of the component anchorage is adequate to demonstrate compliance (see Section 13.6). In other cases (e.g., motor control centers and switching equipment), shake table testing may be required. Components that contain hazardous materials (e.g., tanks, piping, and vessels) typically are qualified by analysis, but it may be necessary to qualify certain operational valving or mechanical equipment within the system by other means.

C13.2.3 Consequential Damage. Although the components identified in Tables 13.5-1 and 13.6-1 are listed separately, significant interrelationships exist and must be considered. Consequential damage occurs due to interaction between components and systems. Even "braced" components displace and the displacement between lateral supports can be significant in the case of distributed systems such as piping systems, cable and conduit systems and other linear systems. It is the intent of the standard that the seismic displacements considered include both relative displacement between multiple points of support (addressed in Section 13.3.2) and, for mechanical and electrical components, displacement within the component assemblies. Impact of components must be avoided unless the components are fabricated of ductile materials that have been shown to be capable of accommodating the expected impact loads. With protective coverings, ductile mechanical and electrical components and many more fragile components are expected to survive all but the most severe impact loads. Flexibility and ductility of the connections between distribution systems and the equipment to which they attach is essential to the seismic performance of the system.

The determination of the displacements that generate these interactions are not addressed explicitly in Section 13.3.2.1. That section concerns relative displacement of support points. Consequential damage may occur due to displacement of components and systems between support points. For example, in older suspended ceiling installations, excessive lateral displacement of a ceiling system may fracture sprinkler heads that project through the ceiling. A similar situation may arise if sprinkler heads projecting from a small diameter branch line pass through a rigid ceiling system. While the branch line may be properly restrained, it may still displace sufficiently between lateral support points, to impact other components or systems. Similar interactions occur where a relatively flexible distributed system connects to a braced or rigid component.

The potential for impact between components that are in contact with or in close proximity to other structural or nonstructural components must be considered. However, where considering these potential interactions, the designer must determine if the potential interaction is both credible and significant. For example, the fall of a ceiling panel located above a motor control center is a credible interaction because the falling panel in older suspended ceiling installations can reach and impact the motor control center. An interaction is significant if it can result in damage to the target. Impact of a ceiling panel on a motor control center may not be significant, due to the light weight of the ceiling panel. Special design consideration is appropriate where the failure of a nonstructural element could adversely influence the performance of an adjacent critical nonstructural component, such as an emergency generator.

C13.2.4 Flexibility. In many cases, flexibility is more important than strength in the performance of distributed systems, such as piping and ductwork. A good understanding of the displacement demand on the system as well as its displacement capacity is required. Components or their supports and attachments must be flexible enough to accommodate the full range of expected differential movements; some localized inelasticity is permitted in accommodating the movements. Relative movements in all directions must be considered. For example, even a braced branch line of a piping system will displace, so it needs to be connected to other braced or rigid components in a manner that will accommodate the displacements without failure (see Figure C13.2-1). For another example, cladding units (such as precast concrete wall units) while often very rigid in-plane, if supported at more than one level, require connections capable of accommodating story drift. (See Section C13.5.3 for an illustration.)

If component analysis assumes rigid anchors or supports, the predicted loads and local stresses can be unrealistically large, so it may be necessary to consider anchor and/or support stiffness.

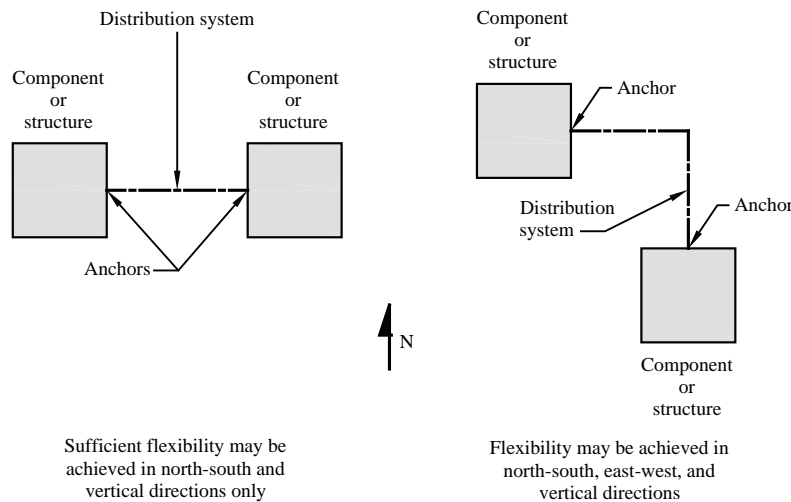

Figure C13.2-1 Schematic plans illustrating branch line flexibility.

C13.2.5 Testing Alternative for Seismic Capacity Determination. Testing is a well established alternative method of seismic qualification for small- to medium-size equipment. Several national reference documents have testing requirements adaptable for seismic qualification. One such reference document, ICC-ES AC156 (2007), is a shake-table testing protocol that has been adopted by the ICC Evaluation Service. It was developed specifically to be consistent with acceleration demands (that is, force requirements) of the standard.

The development or selection of testing and qualification protocols should at a minimum include the following:

1. Description of how the protocol meets the intent for the project-specific requirements and relevant interpretations of the standard.
2. Definition of a test input motion with a response spectrum that meets or exceeds the Design Earthquake spectrum for the site.
3. Accounting for dynamic amplification due to above-grade equipment installations. Consideration of the actual dynamic characteristics of the primary support structure is permitted, but not required.
4. Definition of how shake-table input demands were derived.
5. Definition and establishment of a verifiable pass/fail acceptance criterion for the seismic qualification based upon the equipment importance factor and consistent with the building code and project-specific design intent.

6. Development of criteria that can be used to rationalize test unit configuration requirements for highly variable equipment product lines.

To aid the design professional in assessing the adequacy of the manufacturer's certificate of compliance it is recommended that certificates of compliance include:

1. Product family or group covered
2. Building code(s) and standard(s) for which compliance was evaluated
3. Testing standard used
4. Performance objective and corresponding importance factor ($I_p = 1.0$ or $I_p = 1.5$)
5. Seismic demand for which the component is certified, including code and/or standard design parameters used to calculate seismic demand (such as values used for a_p , R_p , and site class)
6. Installation restrictions, if any (grade, floor, or roof level)

Without a test protocol recognized by the building code, qualification testing is inconsistent and difficult to verify. The use of ICC-ES AC156 simplifies the task of compliance verification since it was developed to address directly the testing alternative for nonstructural components, as specified in the standard. It also sets forth minimum test plan and report deliverables.

Use of other standards or ad-hoc protocols to verify compliance of nonstructural components with the requirement of the standard should be considered carefully and used only where project-specific requirements cannot be met otherwise.

Where other qualification test standards will be used, in whole or in part, it is necessary to verify compliance with this standard. For example, IEEE 693 indicates that it is to be used for the sole purpose of qualifying electrical equipment (specifically listed in the standard) for use in utility substations. Where equipment testing has been conducted to other standards (for instance, testing done in compliance with IEEE 693), a straightforward approach would be to permit evaluation, by the manufacturer, of the test plan and data to validate compliance with the requirements of ICC-ES AC156, because it was developed specifically to comply with the seismic demands of this standard.

The qualification of mechanical and electrical components for seismic loads alone may not be sufficient to achieve high performance objectives. Establishing a high confidence that performance goals will be met requires consideration of the performance of structures, systems (fluid, mechanical, electrical, instrumentation, etc.), and their interactions (for example interaction of seismic and other loads) as well as compliance with installation requirements.

C13.2.6 Experience Data Alternative for Seismic Capacity Determination. An established method of seismic qualification for certain types of nonstructural components is the assessment of data for the performance of similar components in past earthquakes. The seismic capacity of the component in question is extrapolated based on estimates of the demands (force, displacement) to which the components in the database were subjected. Procedures for such qualification have been developed for use in nuclear facility applications by the Seismic Qualification Utility Group (SQUG) of the Electric Power Research Institute.

The SQUG rules for implementing the use of experience data are described in a proprietary Generic Implementation Procedure (GIP) database. It is a collection of findings from detailed engineering studies by experts for equipment from a variety of utility and industrial facilities.

Valid use of experience data requires satisfaction of rules that address physical characteristics, manufacturer's classification and standards, and findings from testing, analysis, and expert consensus opinion.

Four criteria are used to establish seismic qualification by experience, as follows:

1. Seismic capacity versus demand (a comparison with a bounding spectrum)
2. Earthquake experience database cautions and inclusion rules
3. Evaluation of anchorage
4. Evaluation of seismic interaction

Experience data should be used with care, since the design and manufacture of components may have changed considerably in the intervening years. The use of this procedure is also limited by the relative rarity of strong motion instrument records associated with corresponding equipment experience data.

C13.2.7 Construction Documents. Where the standard requires seismic design of components or their supports and attachments, appropriate construction documents defining the required construction and installation must be prepared. This facilitates the special inspection and testing needed to provide a reasonable level of quality assurance. Of particular concern are large nonstructural components (such as rooftop chillers) whose manufacture and installation involves multiple trades and

suppliers, and which impose significant loads on the supporting structure. In these cases, it is important that the construction documents used by the various trades and suppliers to satisfy the seismic design requirements are prepared by a registered design professional.

The information required to prepare construction documents for component installation includes the dimensions of the component, the locations of attachment points, the operating weight, and the location of the center of mass. For instance, if an anchorage angle will be attached to the side of a metal chassis, the gage and material of the chassis must be known so that the number and size of required fasteners can be determined. Or, when a piece of equipment has a base plate that will be anchored to a concrete slab with expansion anchors, the drawings must show the base plate's material and thickness, the diameter of the bolt holes in the plate, and the size and depth of embedment of the anchor bolts. If the plate will be elevated above the slab for leveling, the construction documents must also show the maximum gap permitted between the plate and the slab.

C13.3 SEISMIC DEMANDS ON NONSTRUCTURAL COMPONENTS

The seismic demands on nonstructural components, as defined in this section, are acceleration demands and relative displacement demands. Acceleration demands are represented by equivalent static forces. Relative displacement demands are provided directly and are based on either the actual displacements computed for the structure or the maximum allowable drifts that are permitted for the structure.

C13.3.1 Seismic Design Force. The seismic design force for a component depends on the weight of the component, the component importance factor, the component response modification factor, the component amplification factor, and the component acceleration at a point of attachment to the structure. The forces prescribed in this section of the standard reflect the dynamic and structural characteristics of nonstructural components. As a result of these characteristics, forces used for verification of component integrity and design of connections to the supporting structure typically are larger than those used for design of the overall seismic-force-resisting system.

Certain nonstructural components lack the desirable attributes of structures (such as ductility, toughness, and redundancy) that permit the use of greatly reduced lateral design forces. Thus values for the response modification factor, R_p , in Tables 13.5-1 and 13.6-1 generally are smaller than R values for structures. These R_p values, used to represent the energy absorption capability of a component and its attachments, depend on both overstrength and deformability. At present these potentially separate considerations are combined in a single factor. The tabulated values are based on the collective judgment of the responsible committee.

The 2005 edition of the standard includes significant adjustments to tabulated R_p values for certain mechanical and electrical systems. For example, the value of R_p for welded steel piping systems is increased from 3.5 to 9. The a_p value increased from 1.0 to 2.5, so while it might appear that forces on such piping systems have been reduced greatly, the net change is negligible, as R_p/a_p changes from 3.5 to 3.6. The minimum seismic design force of Equation 13.3-3, which governs in many cases, is unchanged.

The component amplification factor (a_p) represents the dynamic amplification of component responses as a function of the fundamental periods of the structure (T) and component (T_p). When components are designed or selected, the structural fundamental period is not always defined or readily available. The component fundamental period (T_p) is usually only accurately obtained by shake-table or pull-back tests and is not available for the majority of components. Tabulated a_p values are based on component behavior that is assumed to be either rigid or flexible. Where the fundamental period of the component is less than 0.06 seconds, dynamic amplification is not expected, and the component is considered rigid. The tabulation of assumed a_p values is not meant to preclude more precise determination of the component amplification factor where the fundamental periods of both structure and component are available. The NCEER formulation shown in Figure C13.3-1 may be used to compute a_p as a function of T_p/T .

Dynamic amplification occurs where the period of a nonstructural component closely matches that of any mode of the supporting structure, although this effect may not be significant depending on the ground motion. For most buildings, the primary mode of vibration in each direction will have the most influence on the dynamic amplification for nonstructural components. For long-period structures (such as tall buildings), where the period of vibration of the fundamental mode is greater than 3.5 times T_s , higher modes of vibration may have periods that more closely match the period of nonstructural components. For this case, it is recommended that amplification be considered using such higher mode periods in lieu of the higher fundamental period. This approach may be generalized by computing floor response spectra for various levels that reflect the dynamic characteristics of the supporting structure to determine how amplification will vary as a function of component period. Calculation of floor response spectra can be complex, but simplified procedures are presented in Kehoe and Hachem (2003). Consideration of nonlinear behavior of the structure greatly complicates the analysis.

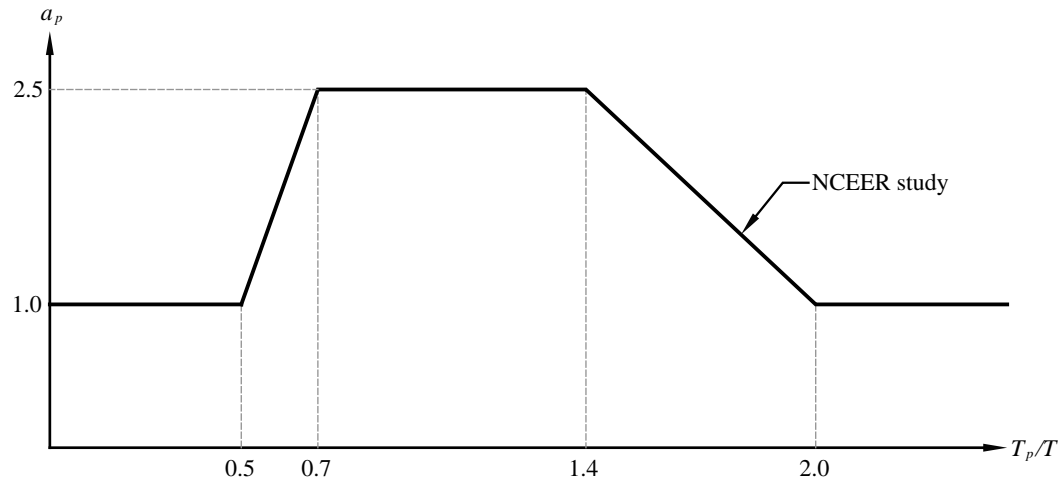

Figure C13.3-1 NCEER formulation for a_p as function of structural and component periods.

Equation 13.3-1 represents a trapezoidal distribution of floor accelerations within a structure, varying linearly from the acceleration at the ground (taken as $0.4S_{DS}$) to the acceleration at the roof (taken as $1.2S_{DS}$). The ground acceleration ($0.4S_{DS}$) is intended to be the same acceleration used as design input for the structure itself, including site effects. The roof acceleration is established as three times the input ground acceleration based on examination of recorded in-structure acceleration data for short and moderate height structures in response to large California earthquakes. Work by Miranda and Singh suggest that, for taller structures, the amplification with height may vary significantly due to higher mode effects. Where more information is available, Equation 13.3-4 permits an alternate determination of the component design forces based on the dynamic properties of the structure.

Equation 13.3-3 establishes a minimum seismic design force, F_p , that is consistent with current practice. Equation 13.3-2 provides a simple maximum value of F_p that prevents multiplication of the individual factors from producing a design force that would be unreasonably high, considering the expected nonlinear response of support and component. Figure C13.3-2 illustrates the distribution of the specified lateral design forces.

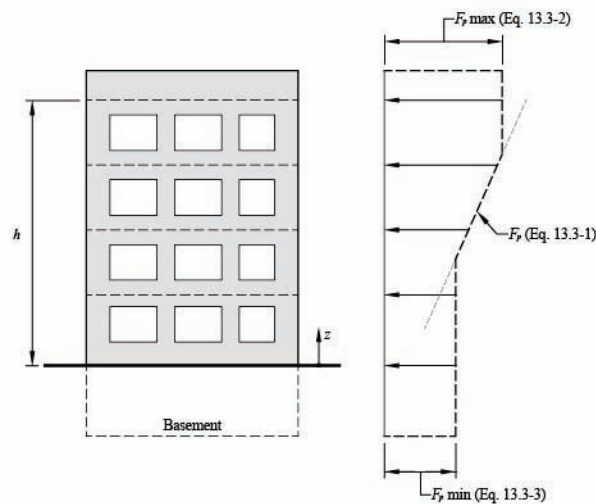

Figure C13.3-2 Lateral force magnitude over height.

For elements with points of attachment at more than one height, it is recommended that design be based on the average of values of F_p determined individually at each point of attachment (but with the entire component weight, W_p) using Equations 13.3-1 through 13.3-3.

Alternatively, for each point of attachment a force F_p may be determined using Equations 13.3-1 through 13.3-3, with the portion of the component weight, W_p , tributary to the point of attachment. For design of the component, the attachment force F_p must be distributed relative to the component's mass distribution over the area used to establish the tributary weight. To

illustrate these options, consider a solid exterior nonstructural wall panel, supported top and bottom, for a one-story building with a rigid diaphragm. The values of F_p computed, respectively, for the top and bottom attachments using Equations 13.3-1 through 13.3-3 are $0.48S_{DS}I_pW_p$ and $0.30S_{DS}I_pW_p$. In the recommended method, a uniform load is applied to the entire panel based on $0.39S_{DS}I_pW_p$. In the alternative method, a trapezoidal load varying from $0.48S_{DS}I_pW_p$ at the top to $0.30S_{DS}I_pW_p$ at the bottom is applied. Each anchorage force is then determined considering static equilibrium of the complete component subject to all the distributed loads.

Cantilever parapets that are part of a continuous element should be checked separately for parapet forces. The seismic force on any component must be applied at the center of gravity of the component and must be assumed to act in any horizontal direction. Vertical forces on nonstructural components equal to $\pm 0.2S_{DS}W_p$ are specified in Section 13.3.1 and are intended to be applied to all nonstructural components and not just cantilevered elements. Nonstructural concrete or masonry walls laterally supported by flexible diaphragms must be anchored out-of-plane in accordance with Section 12.11.2.

C13.3.2 Seismic Relative Displacements. The equations of this section are for use in design of cladding, stairways, windows, piping systems, sprinkler components, and other components connected to one structure at multiple levels or to multiple structures. Two equations are given for each situation. Equations 13.3-5 and 13.3-7 produce structural displacements as determined by elastic analysis, unreduced by the structural response modification factor (R). Since the actual displacements may not be known when a component is designed or procured, Equations 13.3-6 and 13.3-8 provide upper-bound displacements based on structural drift limits. Use of upper-bound equations may facilitate timely design and procurement of components, but may also result in costly added conservatism.

The standard does not provide explicit acceptance criteria for the effects of seismic relative displacements, except for glazing. Damage to nonstructural components due to relative displacement is acceptable, provided the performance goals defined elsewhere in the chapter are achieved.

C13.3.2.1 Displacements within Structures. Seismic relative displacements can subject components or systems to unacceptable stresses. Nonstructural components designed with no intended structural function, such as infill walls, may interact with structural framing elements as a result of building deformation. The resulting stresses may exceed acceptable limits for the nonstructural components, the structural elements, or both. Consideration of this interrelationship is likely to govern the clearance between such components and the ductility and strength of their supports and attachments.

Where nonstructural components are supported between, rather than at, structural levels, as frequently occurs for glazing systems, partitions, stairs, veneers, and mechanical and electrical distributed systems, the height over which the displacement demand, D_p , must be accommodated may be less than the story height, h_{sx} , and should be considered carefully. For example, consider the glazing system supported by rigid precast concrete spandrels shown in Figure C13.3-3. The glazing system will be subjected to full story drift, D_p , although its height ($h_x - h_y$) is only a fraction of the story height. The design drift must be accommodated by anchorage of the glazing unit, the joint between the precast spandrel and the glazing unit, or some combination of the two. Similar displacement demands arise where pipes, ducts, or conduit that are braced to the floor or roof above are connected to the top of a tall, rigid, floor-mounted component.

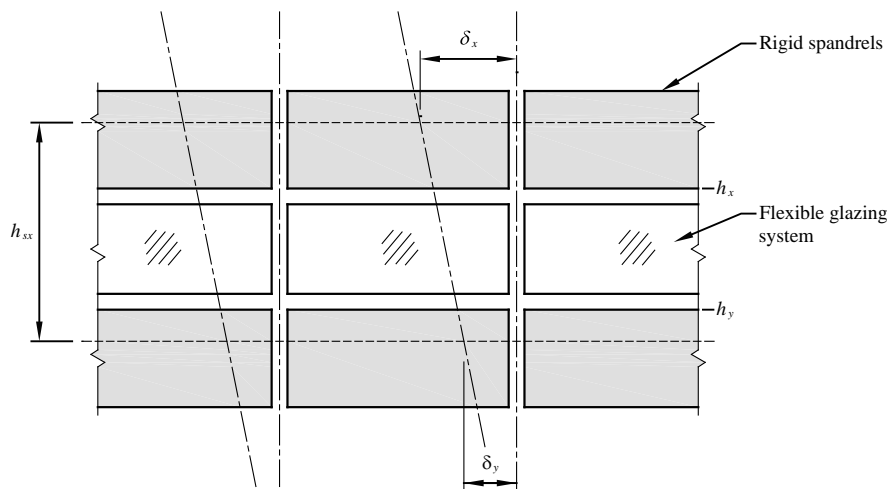

Figure C13.3-3 Displacements over less than story height.

For ductile components, such as steel piping fabricated with welded connections, the relative seismic displacements between support points can be more significant than inertial forces. Ductile piping can accommodate relative displacements by local

yielding with strain accumulations well below failure levels. However, for components fabricated using less ductile materials, where local yielding must be avoided to prevent unacceptable failure consequences, relative displacements must be accommodated by flexible connections.

C13.3.2.2 Displacements between Structures. A component or system connected to two structures must accommodate horizontal movements in any direction, as illustrated in Figure C13.3-4.

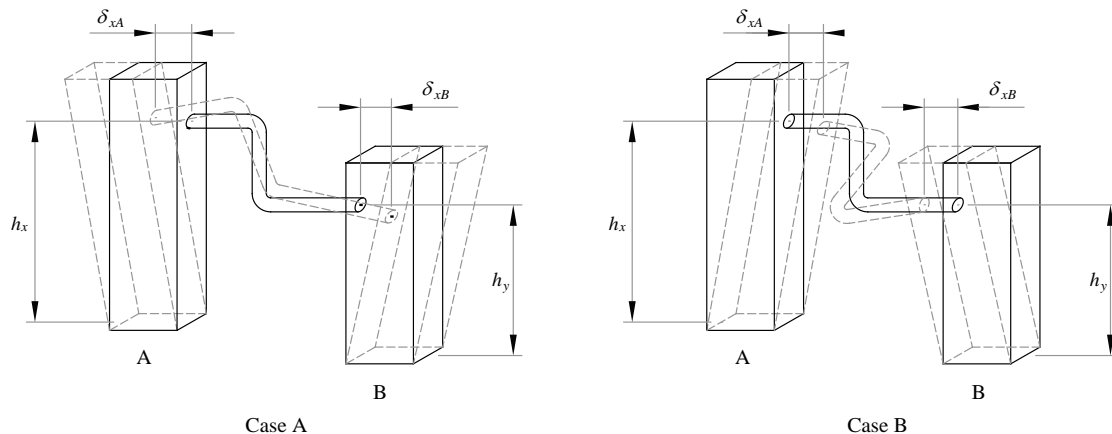

Figure C13.3-4 Displacements between structures.

C13.4 NONSTRUCTURAL COMPONENT ANCHORAGE

Unless exempted in Section 13.1.4, components must be anchored to the structure, and all required supports and attachments must be detailed in the construction documents. To satisfy the load path requirement of this section, the detailed information described in Section C13.2.7 must be communicated, during the design phase, to the registered design professional responsible for the design of the supporting structure.

Unanchored components often rock or slide when subjected to earthquake motions. Since this behavior may have serious consequences, is difficult to predict, and is exacerbated by vertical ground motions, positive restraint must be provided for each component.

The effective seismic weight used in design of the seismic force-resisting system must include the weight of supported components. To satisfy the load path requirements of this section, localized component demand must also be considered. This may be accomplished by checking the capacity of the first structural element in the load path (for example, a floor beam directly under a component) for combined dead, live, operating, and seismic loads, using the horizontal and vertical loads from Section 13.3.1 for the seismic demand, and repeating this procedure for each structural element or connection in the load path until the load case including horizontal and vertical loads from Section 13.3.1 no longer governs design of the element. The load path includes housekeeping slabs and curbs, which must be adequately reinforced and positively fastened to the supporting structure.

Since the exact magnitude and location of loads imposed on the structure may not be known until nonstructural components are ordered, the initial design of supporting structural elements should be based on conservative assumptions. The design of the supporting structural elements must be verified once the final magnitude and location of the design loads have been established.

Tests have shown there are consistent shear ductility variations between bolts installed in drilled or punched plates with nuts and connections using welded shear studs. The need for reductions in allowable loads for particular anchor types to account for loss of stiffness and strength may be determined through appropriate dynamic testing. Although comprehensive design recommendations are not available at present, this issue should be considered for critical connections subject to dynamic or seismic loading.

C13.4.2 Anchors in Concrete or Masonry. Design capacity for anchors in concrete must be determined in accordance with ACI 318 Appendix D. Design capacity for anchors in masonry is determined in accordance with ACI 530. Anchors must be designed to have ductile behavior or to provide a specified degree of excess strength. In either case, design forces are

multiplied by 1.3 or based on the capacity of the component or its supports. The anchorage criteria provided in Chapter 13 specifically address the issue of non-ductile response and force amplification. Since the capacity of anchors in masonry is rarely governed by steel capacity, and failure in the masonry is non-ductile, an R_p of 1.5 should be used for design. Depending on the specifics of the design condition, ductile design of anchors in concrete may satisfy one or more of the following objectives:

1. Adequate load redistribution between anchors in a group
2. Allowance for anchor overload without brittle failure
3. Energy dissipation

Achieving deformable, energy-absorbing behavior in the anchor itself is often difficult. Unless the design specifically addresses the conditions influencing desirable hysteretic response (adequate gauge length, anchor spacing, edge distance, steel properties, etc.), anchors cannot be relied upon for energy dissipation. Simple geometric rules, such as restrictions on the ratio of anchor embedment length to depth, are not adequate to produce reliable ductile behavior. For example, a single anchor with sufficient embedment to force ductile tension failure in the steel body of the anchor bolt may still experience concrete fracture (a non-ductile failure mode) if the edge distance is small, the anchor is placed in a group of tension-loaded anchors with reduced spacing, or the anchor is loaded in shear instead of tension. In the common case where anchors are subject primarily to shear, response governed by the steel element may be non-ductile if the deformation of the anchor is constrained by rigid elements on either side of the joint. Designing the attachment so that its response is governed by a deformable link in the load path to the anchor is encouraged. This approach provides ductility and overstrength in the connection while protecting the anchor from overload. Ductile bolts should only be relied upon as the primary ductile mechanism of a system if the bolts are designed to have adequate gauge length (unbonded strained length of the bolt) to accommodate the anticipated nonlinear displacements of the system at the design earthquake. Guidance for determining the gauge length can be found in Part 3 of the *Provisions*.

Post-installed expansion and undercut anchors must be qualified in accordance with ACI 355.2-04, *Qualification of Post-Installed Mechanical Anchors in Concrete*. The ICC-ES acceptance criteria AC193 and AC308, which include specific provisions for screw anchors and adhesive anchors, also reference ACI 355.2. Reference to adhesives (such as in Section 13.5.7.2) apply, not to adhesive anchors, but to steel plates and other structural elements bonded or glued to the surface of another structural component with adhesive; such connections are generally non-ductile.

Anchors used to support towers, masts, and equipment are often provided with double nuts for leveling during installation. Where baseplate grout is specified at anchors with double nuts, it should not be relied upon to carry loads since it can shrink and crack or be omitted altogether. The design should include the corresponding tension, compression, shear, and flexure loads.

C13.4.3 Installation Conditions. Prying forces on anchors, which result from a lack of rotational stiffness in the connected part, can be critical for anchor design and must be considered explicitly.

For anchorage configurations that do not provide a direct mechanism to transfer compression loads (for example, a base plate that does not bear directly on a slab or deck but is supported on a threaded rod), the design for overturning must reflect the actual stiffness of baseplates, equipment, housing, and other elements in the load path when computing the location of the compression centroid and the distribution of uplift loads to the anchors.

C13.4.4 Multiple Attachments. While the standard does not prohibit the use of single anchor connections, it is good practice to use at least two anchors in any load-carrying connection whose failure might lead to collapse, partial collapse, or disruption of a critical load path.

C13.4.5 Power Actuated Fasteners. The capacity of power actuated fasteners in concrete often varies more than that of drilled post-installed anchors. The shallow embedment, small diameter, and friction mechanism of these fasteners make them particularly susceptible to the effects of concrete cracking. The suitability of power actuated fasteners to resist tension in concrete should be demonstrated by simulated seismic testing in cracked concrete.

Where properly installed in steel, power actuated fasteners typically exhibit reliable cyclic performance. Nevertheless, they should not be used singly to support suspended elements. Where used to attach cladding and metal decking, subassembly testing may be used to establish design capacities since the interaction between the decking, the sub-frame, and the fastener can only be estimated crudely by currently available analysis methods.

C13.4.6 Friction Clips. Friction clips, such as beam clamps, may loosen under cyclic loading, resulting in slippage or loss of connection capacity. Where friction clips are used, they may not be relied upon for seismic resistance. Fasteners that provide a positive mechanical connection have more reliable seismic performance. Clips that provide marginal mechanical

connection, such as beam clamps that “dimple” the flange of the steel support may still rely chiefly on friction. These may not provide adequate cyclic capacity and should be qualified by seismic testing.

C13.5 ARCHITECTURAL COMPONENTS

For structures in Occupancy Category I through III, the requirements of Section 13.5 are intended to reduce property damage and life-safety hazards posed by architectural components due to loss of stability or integrity. When subjected to seismic motion, components may pose a direct falling hazard to building occupants or to people outside the building (as in the case of parapets, exterior cladding, and glazing). Failure or displacement of interior components (such as partitions and ceiling systems in exits and stairwells) may block egress.

For structures in Occupancy Category IV, the potential disruption of essential function due to component failure must also be considered.

Architectural component failures in earthquakes can be caused by deficient design or construction of the component, interrelationship with another component that fails, interaction with the structure, or inadequate attachment or anchorage. For architectural components, attachment and anchorage are typically the most critical concerns related to their seismic performance. Concerns regarding loss of function are most often associated with mechanical and electrical components. Architectural damage, unless very severe, can be accommodated temporarily. Very severe architectural damage is often accompanied by significant structural damage.

C13.5.1 General. Suspended architectural components are not required to satisfy the force and displacement requirements of Chapter 13, where prescriptive requirements are met. The requirements were relaxed in the 2005 edition of the standard to better reflect the consequences of the expected behavior. For example, impact of a suspended architectural ornament with a sheet metal duct may only dent the duct without causing a credible danger (assuming the ornament remains intact). The reference to Section 13.2.3 allows the designer to consider such consequences in establishing the design approach.

C13.5.2 Forces and Displacements. Partitions and interior and exterior glazing must accommodate story drift without failure that will cause a life-safety hazard. Design judgment must be used to assess potential life-safety hazards and the likelihood of life-threatening damage. Special detailing to accommodate drift for typical gypsum board or demountable partitions is unlikely to be cost-effective, and damage to these components poses a low hazard to life safety. Damage in these partitions occurs at low drift levels, but is inexpensive to repair.

If they must remain intact following strong ground motion, nonstructural fire-resistant enclosures and fire-rated partitions require special detailing that provides isolation from the adjacent or enclosing structure for deformation equivalent to the calculated drift (relative displacement). In-plane differential movement between structure and wall is permitted. Provision must be made for out-of-plane restraint. These requirements are particularly important in steel or concrete moment frame structures, which experience larger drifts. The problem is less likely to be encountered in stiff structures, such as those with shear walls.

Differential vertical movement between horizontal cantilevers in adjacent stories (such as cantilevered floor slabs) has occurred in past earthquakes. The possibility of such effects should be considered in the design of exterior walls.

C13.5.3 Exterior Nonstructural Wall Elements and Connections. Nonbearing wall panels that are attached to and enclose the structure must be designed to resist seismic (inertial) forces, wind forces, and gravity forces and to accommodate movements of the structure resulting from lateral forces and temperature change. The connections must allow wall panel movements due to thermal and moisture changes, and be designed so as to prevent the loss of load-carrying capacity in the event of significant yielding. Where wind loads govern, common practice is to design connectors and panels to allow for not less than two times the story drift caused by wind loads determined using a return period appropriate to the site location.

Design to accommodate seismic relative displacements often presents a greater challenge than design for strength. Story drifts can amount to 2 inches (50 mm) or more. Separations between adjacent panels are intended to limit contact and resulting panel misalignment or damage under all but extreme building response. Section 13.5.3(a) calls for a minimum separation of 1/2 inch (13 mm). For practical joint detailing and acceptable appearance, separations typically are limited to about 3/4 inch (19 mm). Manufacturing and construction tolerances for both wall elements and the supporting structure must be considered in establishing design joint dimensions and connection details.

Cladding elements, which are often very stiff in-plane, must be isolated so that they do not restrain and are not loaded by drift of the supporting structure. Slotted connections can provide isolation, but connections with long rods that flex achieve the desired behavior without requiring precise installation. Such rods must be designed to resist tension and compression in addition to induced flexural stresses, brittle, low-cycle fatigue failure.

Full-story wall panels are usually rigidly attached to and move with the floor structure nearest the panel bottom and isolated at the upper attachments. Panels also can be vertically supported at the top connections with isolation connections at the bottom. An advantage of this configuration is that failure of an isolation connection is less likely to result in complete detachment of the panel, since it will tend to rotate into the structure rather than away from it.

To minimize the effects of thermal movements and shrinkage on architectural cladding panels, connection systems are generally detailed to be statically determinate. Since the resulting support systems often lack redundancy, exacerbating the consequences of a single connection failure, fasteners must be designed for amplified forces and connecting members must be ductile. The intent is to keep inelastic behavior in the connecting members while the more brittle fasteners remain essentially elastic. To achieve this intent, the tabulated a_p and R_p values produce fastener design forces that are about 3 times those for the connecting members.

Limited deformability curtain walls, such as aluminum systems, are generally light and can undergo large deformations without separating from the structure. However, care must be taken in design of these elements so that low deformability components (as defined in Section 11.2) that may be part of the system, such as glazing panels, are detailed to accommodate the expected deformations without failure.

In Table 13.5-1, veneers are classified as either limited or low deformability elements. Veneers with limited deformability, such as vinyl siding, pose little risk. Veneers with low deformability, such as brick and ceramic tile, are highly sensitive to the performance of the supporting substrate. Significant distortion of the substrate results in veneer damage, possibly including separation from the structure. The resulting risk depends on the size and weight of fragments likely to be dislodged and on the height from which the fragments would fall. Detachment of large portions of the veneer can pose a significant risk to life. Such damage can be reduced by isolating veneer from displacements of the supporting structure. For structures with flexible lateral force-resisting systems, such as moment frames and buckling-restrained braced frames, approaches used to design non-bearing wall panels to accommodate story drift should be applied to veneers.

C13.5.5 Out-of-Plane Bending. The effects of out-of-plane application of seismic forces (defined in Section 13.3.1) on nonstructural walls, including the resulting deformations, must be considered. Where weak or brittle materials are employed, conventional deflection limits are expressed as a proportion of the span. The intent is to preclude out-of-plane failure of heavy materials (such as brick or block) or applied finishes (such as stone or tile).

C13.5.6 Suspended Ceilings. Suspended ceiling systems are fabricated using a wide range of building materials with differing characteristics. Some systems (such as lath and plaster or gypsum board, screwed or nailed to suspended members) are fairly homogeneous and should be designed as light-frame diaphragm assemblies, using the forces of Section 13.3 and the applicable material-specific design provisions of Chapter 14. Others comprise discrete elements laid into a suspension system and are the subject of this section.

Seismic performance of ceiling systems with lay-in or acoustical panels depends on support of the grid and individual panels at walls and expansion joints, integrity of the grid/panel assembly, interaction with other systems (such as fire sprinklers), and support for other nonstructural components (such as light fixtures and HVAC systems). Observed performance problems include dislodgement of tiles due to impact with walls and water damage (sometimes leading to loss of occupancy) due to interaction with fire sprinklers. Extensive shake table testing performed at the State University of New York at Buffalo addresses seismic performance of suspended ceiling systems at various ground motion levels. That work is reported by Yao (2000) and by Bidillo, et al. (2003, 2006, and 2007).

The performance of ceiling systems is affected by the placement of seismic bracing and the layout of light fixtures and other supported loads. Dynamic testing has demonstrated that splayed wires, even with vertical compression struts, may not adequately limit lateral motion of the ceiling system due to straightening of the end loops. Construction problems include slack installation or omission of bracing wires due to obstructions. Other testing has shown that unbraced systems may perform well where the system can accommodate the expected displacements, by providing both sufficient clearance at penetrations and wide closure members which are now required by the standard.

C13.5.6.1 Seismic Forces. Where the weight of the ceiling system is distributed non-uniformly, that condition should be considered in the design, since the typical T-bar ceiling grid has limited ability to redistribute lateral loads.

C13.5.6.2 Industry Standard Construction. Industry standard construction relies on ceiling contact with the perimeter wall for restraint. The key to good seismic performance is sufficiently wide closure angles at the perimeter to accommodate relative ceiling motion and adequate clearance at penetrating components (such as columns and piping) to avoid concentrating restraining loads on the ceiling system.

C13.5.6.2.1 Seismic Design Category C. While there is no direct equivalency between Seismic Design Categories and seismic zones, application of CISC requirements for Seismic Zones 0 to 2 produces reasonable results for Seismic Design

Category C. ASTM E580 is currently being revised for consistency with the IBC and ASCE/SEI 7-05. When updated, it is expected to replace the CISCA requirements.

C13.5.6.2.2 Seismic Design Categories D through F. Where certain prescriptive requirements are met, lateral restraints may be omitted for small areas of suspended ceiling. The behavior of an unbraced ceiling system is similar to that of a pendulum; therefore, the lateral displacement is a function of the level of ground motion and the square root of the suspension length. The default displacement limit is based on anticipated damping and energy absorption of the suspended ceiling system without significant impact with the perimeter wall.

The requirements set forth in this section of the standard for Seismic Design Categories D through F are in addition to the CISCA requirements for Seismic Zones 3 and 4. Therefore, seismic requirements for ceilings are triggered where ceiling areas exceed 256 square feet, and additional requirements apply where ceiling areas exceed 1,000 square feet and 2,500 square feet. The alternative to provide swing joint connections or flexible devices (such as hoses) for sprinkler drops is included in the latest edition of NFPA 13.

C13.5.6.3 Integral Construction. Ceiling systems utilizing integral construction are constructed of modular pre-engineered components, which integrate lights, ventilation components, fire-sprinklers, and seismic bracing into a complete system. They may include aluminum, steel, and PVC components and may be designed using integral construction of ceiling and wall. They often use rigid grid and bracing systems, which provide lateral support for all the ceiling components, including sprinkler drops. This reduces the potential for adverse interactions between components, and eliminates the need to provide clearances for differential movement.

C13.5.7 Access Floors

C13.5.7.1 General. In past earthquakes and in cyclic load tests, some typical raised access floor systems behaved in a brittle manner and exhibited little reserve capacity beyond initial yielding or failure of critical connections. Testing shows that unrestrained individual floor panels may pop out of the supporting grid unless mechanically fastened to supporting pedestals or stringers. This may be a concern, particularly in egress pathways.

For systems with floor stringers, it is accepted practice to calculate the seismic force, F_p , for the entire access floor system within a partitioned space and then distribute the total force to the individual braces or pedestals. For stringerless systems, the seismic load path should be established explicitly.

Overtopping effects subject individual pedestals to vertical loads well in excess of the weight, W_p , used in determining the seismic force, F_p . It is unconservative to use the design vertical load simultaneously with the design seismic force for design of anchor bolts, pedestal bending, and pedestal welds to base plates. “Slip on” heads that are not mechanically fastened to the pedestal shaft and thus cannot transfer tension are likely unable to transfer to the pedestal the overturning moments generated by equipment attached to adjacent floor panels.

To preclude brittle failure, each element in the seismic load path must have energy absorbing capacity. Buckling failure modes should be prevented. Lower seismic force demands are allowed for special access floors that are designed to preclude brittle and buckling failure modes.

C13.5.7.2 Special Access Floors. An access floor can be a “special access floor” if the registered design professional opts to comply with the requirements of Section 13.5.7.2. Special access floors include construction features that improve the performance and reliability of the floor system under seismic loading. The provisions focus on providing a reliable load path for seismic shear and overturning forces. Special access floors are designed for smaller lateral forces, and their use is encouraged at facilities with higher nonstructural performance objectives.

C13.5.8 Partitions. Partitions subject to these requirements must have independent lateral support bracing from the top of the partition to the building structure or to a substructure attached to the building structure. Some partitions are designed to span vertically from the floor to a suspended ceiling system. The ceiling system must be designed to provide lateral support for the top of the partition. An exception to this condition is provided to exempt bracing of light (gypsum board) partitions where the load does not exceed the minimum partition lateral load. Experience has shown that partitions subjected to the minimum load can be braced to the ceiling without failure.

C13.5.9 Glass in Glazed Curtain Walls, Glazed Storefronts, and Glazed Partitions. The performance of glass in earthquakes falls into one of four categories:

1. The glass remains unbroken in its frame or anchorage.
2. The glass cracks but remains in its frame or anchorage while continuing to provide a weather barrier, and to be otherwise serviceable.
3. The glass shatters but remains in its frame or anchorage in a precarious condition, likely to fall out at any time.

4. The glass falls out of its frame or anchorage, either in shards or as whole panels.

Categories 1 and 2 satisfy both immediate-occupancy and life-safety performance objectives. Although the glass is cracked in Category 2, immediate replacement is not required. Categories 3 and 4 cannot provide for immediate occupancy, and their provision of life safety depends on the post-breakage characteristics of the glass and the height from which it can fall.

Tempered glass shatters into multiple, pebble-size fragments that fall from the frame or anchorage in clusters. These broken glass clusters are relatively harmless to humans when they fall from limited heights, but they could be harmful when they fall from greater heights.

C13.5.9.1 General. Equation 13.5-1 is derived from *Earthquake Safety Design of Windows*, published in November 1982 by the Sheet Glass Association of Japan and is similar to an equation in Bouwkamp and Meehan (1960) that permits calculation of the story drift required to cause glass-to-frame contact in a given rectangular window frame. Both calculations are based on the principle that a rectangular window frame (specifically, one that is anchored mechanically to adjacent stories of a structure) becomes a parallelogram as a result of story drift, and that glass-to-frame contact occurs when the length of the shorter diagonal of the parallelogram is equal to the diagonal of the glass panel itself. The value $\Delta_{fallout}$ represents the displacement capacity of the system and D_p represents the displacement demand.

The 1.25 factor in the requirements described above reflect uncertainties associated with calculated inelastic seismic displacements of building structures. Wright (1989) states that “post-elastic deformations, calculated using the structural analysis process, may well underestimate the actual building deformation by up to 30 percent. It would therefore be reasonable to require the curtain wall glazing system to withstand 1.25 times the computed maximum interstory displacement to verify adequate performance.”

The reason for Exception 2 to Equation 13.5-1 is that the tempered glass, if shattered, would not produce an overhead falling hazard to adjacent pedestrians, although some pieces of glass may fall out of the frame.

C13.5.9.2 Seismic Drift Limits for Glass Components. As an alternative to the prescriptive approach of Section 13.5.9.1, the deformation capacity of glazed curtain wall systems may be established by test.

C13.6 MECHANICAL AND ELECTRICAL COMPONENTS

These requirements, focused on design of supports and attachments, are intended to reduce the hazard to life posed by loss of component structural stability or integrity. The requirements increase the reliability of component operation but do not address functionality directly. For critical components where operability is vital, Section 13.2.2 provides methods for seismically qualifying the component.

Traditionally, mechanical equipment without rotating or reciprocating components (such as tanks and heat exchangers) is anchored directly to the structure. Mechanical and electrical equipment with rotating or reciprocating components often is isolated from the structure by vibration isolators (such as rubber-in-shear, springs, or air cushions). Heavy mechanical equipment (such as large boilers) may not be restrained at all, and electrical equipment other than generators, which are normally isolated to dampen vibrations, usually is rigidly anchored (for example, switchgear and motor control centers).

Two distinct levels of earthquake safety are considered in the design of mechanical and electrical components. At the usual safety level, failure of the mechanical or electrical component itself due to seismic effects poses no significant hazard. In this case, design of the supports and attachments to the structure is required to avoid a life-safety hazard. At the higher safety level, the component must continue to function acceptably following the design earthquake. Such components are defined as designated seismic systems in Section 11.2 and may be required to meet the special certification requirements of Section 13.2.2.

Not all equipment or parts of equipment need to be designed for seismic forces. Where I_p is specified to be 1.0, damage to, or even failure of, a piece or part of a component does not violate these requirements as long as a life-safety hazard is not created. The restraint or containment of a falling, breaking, or toppling component (or its parts) by means of bumpers, braces, guys, wedges, shims, tethers, or gapped restraints to satisfy these requirements often is acceptable, although the component itself may suffer damage.

Judgment is required to fulfill the intent of these requirements; the key consideration is the threat to life safety. For example, a nonessential air handler package unit that is less than 4 feet (1.2 meters) tall bolted to a mechanical room floor is not a threat to life as long as it is prevented from significant displacement by having adequate anchorage. In this case, seismic design of the air handler itself is unnecessary. On the other hand, a 10-foot (3.0 meters) tall tank on 6-foot (1.8 meters) long angles used as legs, mounted on a roof near a building exit does pose a hazard. The intent of these requirements is that the supports and attachments (tank legs, connections between the roof and the legs, and connections between the legs and the

tank), and possibly even the tank itself be designed to resist seismic forces. Alternatively, restraint of the tank by guys or bracing could be acceptable.

It is not the intent of the standard to require the seismic design of shafts, buckets, cranks, pistons, plungers, impellers, rotors, stators, bearings, switches, gears, nonpressure retaining casings and castings, or similar items. Where the potential for a hazard to life exists, it is expected that design effort will focus on equipment supports including base plates, anchorages, support lugs, legs, feet, saddles, skirts, hangers, braces, or ties.

Many mechanical and electrical components consist of complex assemblies of parts that are manufactured in an industrial process that produces similar or identical items. Such equipment may include manufacturer's catalog items and often are designed by empirical (trial-and-error) means for functional and transportation loadings. A characteristic of such equipment is that it may be inherently rugged. The term "rugged" refers to an amplexness of construction that provides such equipment with the ability to survive strong motions without significant loss of function. By examining such equipment, an experienced design professional usually should be able to confirm such ruggedness. The results of an assessment of equipment ruggedness may be used in determining an appropriate method and extent of seismic design or qualification effort.

C13.6.1 General. The exception allowing unbraced suspended components has been clarified, addressing concerns about the type of nonstructural components allowed by these exceptions as well as the acceptable consequences of interaction between components. In previous editions of the standard, certain nonstructural components that could represent a fire hazard following an earthquake were exempt from lateral bracing requirements. In the revised exception, reference to Section 13.2.3 addresses such concerns while distinguishing between credible seismic interactions and incidental interactions.

The seismic demand requirements are based on component structural attributes of flexibility (or rigidity) and ruggedness. Table 13.6-1 provides seismic coefficients based on judgments of the component flexibility, expressed in the a_p term, and ruggedness expressed in the R_p term. It may also be necessary to consider the flexibility and ductility of the attachment system that provides seismic restraint.

Entries for components and systems in Table 13.6-1 are grouped and described to improve clarity of application. Components are divided into three broad groups, within which they are further classified depending on the type of construction or expected seismic behavior. For example, mechanical components include "air-side" components (such as fans and air handlers) that experience dynamic amplification but are light and deformable; "wet-side" components that generally contain liquids (such as boilers and chillers) that are more rigid and somewhat ductile; and very rugged components (such as engines, turbines, and pumps) that are of massive construction due to demanding operating loads, and generally perform well in earthquakes, if adequately anchored.

A distinction is made between components isolated using neoprene and those that are spring isolated. Spring isolated are assigned a lower R_p value since they tend to have less effective damping. Internally isolated components are classified explicitly to avoid confusion.

C13.6.2 Component Period. Component period is used to clarify components as rigid ($T \leq 0.06s$) or flexible ($T > 0.06s$). Determination of the fundamental period of a mechanical or electrical component using analytical or test methods can become very involved. If not properly performed, the fundamental period may be underestimated, producing unconservative results. The flexibility of the component's supports and attachments typically dominates response and thus fundamental component period. Therefore, analytical determinations of component period must consider those sources of flexibility. Where determined by testing, the dominant mode of vibration of concern for seismic evaluation must be excited and captured by the test setup. This dominant mode of vibration cannot be discovered through in-situ tests that measure only ambient vibrations. To excite the mode of vibration with the highest fundamental period by in-situ tests, relatively significant input levels of motion are required (that is, the flexibility of the base and attachment must be exercised). A resonant frequency search procedure, such as that given in ICC-ES AC156, may be used to identify the dominant modes of vibration of a component.

Many types of mechanical components have fundamental periods below 0.06 seconds and may be considered to be rigid. Examples include horizontal pumps, engine generators, motor generators, air compressors, and motor driven centrifugal blowers. Other types of mechanical equipment are very stiff, but may have fundamental periods up to about 0.125 seconds. Examples include vertical immersion and deep well pumps, belt driven and vane axial fans, heaters, air handlers, chillers, boilers, heat exchangers, filters, and evaporators. These fundamental period estimates do not apply where the equipment is mounted on vibration isolators.

Electrical equipment cabinets can have fundamental periods of about 0.06 to 0.3 seconds, depending upon the supported weight and its distribution, the stiffness of the enclosure assembly, the flexibility of the enclosure base, and the load path through to the attachment points. Tall, narrow motor control centers and switchboards lie at the upper end of this period range. Low- and medium-voltage switchgear, transformers, battery chargers, inverters, instrumentation cabinets, and

instrumentation racks usually have fundamental periods ranging from 0.1 to 0.2 seconds. Braced battery racks, stiffened vertical control panels, benchboards, electrical cabinets with top bracing, and wall-mounted panelboards have fundamental periods ranging from 0.06 to 0.1 seconds.

C13.6.3 Mechanical Components and C13.6.4 Electrical Components. Most mechanical and electrical equipment is inherently rugged and, where properly attached to the structure, has performed well in past earthquakes. Since the operational and transportation loads for which the equipment is designed typically are larger than those due to earthquakes, these requirements focus primarily on equipment anchorage and attachments. However, Designated Seismic Systems, which are required to function following an earthquake or which must maintain containment of flammable or hazardous materials, must themselves be designed for seismic forces or be qualified for seismic loading in accordance with Section 13.2.2.

The likelihood of post-earthquake operability can be increased where the following measures are taken:

1. Internal assemblies, subassemblies, and electrical contacts are attached sufficiently to prevent their being subjected to differential movement or impact with other internal assemblies or the equipment enclosure.
2. Operators, motors, generators, and other such components that are functionally attached to mechanical equipment by means of an operating shaft or mechanism are structurally connected or commonly supported with sufficient rigidity such that binding of the operating shaft will be avoided.
3. Any ceramic or other nonductile components in the seismic load path are specifically evaluated.
4. Adjacent electrical cabinets are bolted together and cabinet lineups are prevented from impacting adjacent structural members.

Components that could be damaged, or could damage other components, and are fastened to multiple locations of a structure must be designed to accommodate seismic relative displacements. Such components include bus ducts, cable trays, conduit, elevator guide rails, and piping systems. As discussed in Section C13.3.2.1, special design consideration is required where full story drift demands are concentrated in a fraction of the story height.

C13.6.5 Component Supports. The intent of this section is to require seismic design of all mechanical and electrical component supports to prevent sliding, falling, toppling, or other movement that could imperil life. Component supports are differentiated here from component attachments to emphasize that the supports themselves, as enumerated in the text, require seismic design even if fabricated by the mechanical or electrical component manufacturer. This is regardless of whether the mechanical or electrical component itself is designed for seismic loads.

C13.6.5.1 Design Basis. Standard supports are those developed in accordance with a reference document (Section 13.1.6). Where standard supports are not used, the seismic design forces and displacement demands of Chapter 13 are used with applicable material-specific design procedures of Chapter 14.

C13.6.5.2 Design for Relative Displacement. For some items, such as piping, seismic relative displacements between support points are of more significance than inertial forces. Components made of high deformability materials such as steel or copper can accommodate relative displacements inelastically, provided the connections also provide high deformability. Threaded and soldered connections exhibit poor ductility under inelastic displacements, even for ductile materials. Components made of less ductile materials can accommodate relative displacement effects only if appropriate flexibility or flexible connections are provided.

Detailing distribution systems that connect separate structures with bends and elbows makes them less prone to damage and less likely to fracture and fall, provided the supports can accommodate the imposed loads.

C13.6.5.3 Support Attachment to Component. As used in this Section, “integral” relates to the manufacturing process, not the location of installation. For example, both the legs of a cooling tower and the attachment of the legs to the body of the cooling tower must be designed, even if the legs are provided by the manufacturer and installed at the plant. Also, if the cooling tower has an $I_p=1.5$, the design must address not only the attachments (welds, bolts, etc.) of the legs to the component but also local stresses imposed on the body of the cooling tower by the support attachments.

C13.6.5.5 Additional Requirements. As reflected in this Section of the standard and in the footnote to Table 13.6-1, vibration isolated equipment with snubbers is subject to amplified loads as a result of dynamic impact.

Use of expansion anchors for non-vibration isolated mechanical equipment rated over 10 hp is prohibited based on experience with older anchor types. The ASCE/SEI 7 Seismic Subcommittee developing the 2010 edition of the standard is considering a proposal that would allow anchors qualified by simulated seismic testing and long-term vibration testing to also be exempt.

C13.6.6 Utility and Service Lines. For essential facilities (Occupancy Category IV), auxiliary on-site mechanical and electrical utility sources are recommended.

Where utility lines pass through the interface of adjacent, independent structures, they must be detailed to accommodate differential displacement computed in accordance with Section 13.3.2 and including the C_d factor of Section 12.2.1.

As specified in Section 13.1.3, nonessential piping whose failure could damage essential utilities in the event of pipe rupture are deemed Designated Seismic Systems.

C13.6.7 HVAC Ductwork. Experience in past earthquakes has shown that HVAC duct systems are rugged and perform well in strong ground shaking. Bracing in accordance with the Sheet Metal and Air Conditioning Contractors National Association ANSI/SMACNA 001 has been effective in limiting damage to duct systems. Typical failures have affected only system function, and major damage or collapse has been uncommon. Therefore, industry standard practices should prove adequate for most installations. Expected earthquake damage is limited to opening of duct joints and tears in ducts. Connection details that are prone to brittle failures, especially hanger rods subject to large amplitude cycles of bending stress, should be avoided.

The amplification factor for ductwork has been increased from 1.0 to 2.5, because even braced duct systems are relatively flexible. The R_p values also have been increased so that the resulting seismic design forces are consistent with those determined previously.

Ductwork systems that carry hazardous materials or must remain operational during and after an earthquake, are assigned a value of $I_p = 1.5$, and require a detailed engineering analysis addressing leak-tightness.

C13.6.8 Piping Systems. In earthquakes, piping systems rarely collapse but often cause nonstructural damage due to leaking. Industry standards and guidelines address a wide variety of piping systems and materials. Construction in accordance with referenced national standards is effective in limiting damage to and avoiding loss of fluid containment in piping systems under earthquake conditions.

ASHRAE's *A Practical Guide to Seismic Restraint*, while not an ANSI standard, is in common use and may be an appropriate reference document for use in the seismic design of piping systems.

The prescriptive conditions provided in the standard under which seismic bracing for piping may be omitted are based on observed performance in past earthquakes.

C13.6.8.1 ASME Pressure Piping Systems. The R_p values tabulated for ASME B31 compliant piping systems reflect the stringent design and quality control requirements as well as the intensified stresses used in ASME design procedures.

C13.6.8.4 Other Piping Systems

Piping not designed in accordance with ASME B31 typically is assigned lower R_p values. Piping component testing suggests that the ductility capacity of carbon steel threaded and grooved joint piping component joints ranges between 1.4 and 3.0. Therefore, these types of connections have been classified as having limited deformability. Grooved couplings and other articulating type of connections may demonstrate free rotational capacity that increases the overall rotational design capacity of the connection. When considered in design, this increase should not exceed 50 percent of the total demonstrated design capacity. The free rotational capacity is the maximum articulating angle where the connection behaves essentially as a pinned joint. The remaining rotational capacity of the connection is where it behaves as a conventional joint whose design force demands are determined by traditional means.

C13.6.9 Boilers and Pressure Vessels

Experience in past earthquakes has shown that boilers and pressure vessels are rugged and perform well in strong ground motion. Construction in accordance with current requirements of the ASME *Boiler and Pressure Vessel Code* (ASME BPVC) has been shown to be effective in limiting damage to and avoiding loss of fluid containment in boilers and pressure vessels under earthquake conditions. It is, therefore, the intent of the standard that nationally recognized codes be used to design boilers and pressure vessels provided that the seismic force and displacement demands are equal to or exceed those outlined in Section 13.3. Where nationally recognized codes do not yet incorporate force and displacement requirements comparable to the requirements of Section 13.3, it is nonetheless the intent to use the design acceptance criteria and construction practices of those codes.

C13.6.10 Elevator and Escalator Design Requirements

The ASME *Safety Code for Elevators and Escalators* (ASME A17.1) has adopted many requirements to improve the seismic response of elevators; however, they do not apply to some regions covered by this chapter. These changes are to extend force requirements for elevators to be consistent with the standard.

C13.6.10.3 Seismic Switches

The purpose of seismic switches as used here is different from that of ASME A17.1, which has incorporated several requirements to improve the seismic response of elevators (such as rope snag point guards, rope retainer guards, and guide rail brackets) and which does not apply to some buildings covered by the standard. Building motions that are expected in areas not covered by the seismic provisions of ASME 17.1 are sufficiently large to impair the operation of elevators. The seismic switch is positioned high in the structure where structural response will be the most severe. The seismic switch trigger level is set to shut down the elevator where structural motions are expected to impair elevator operations.

Elevators in which the seismic switch and counterweight derail device have triggered should not be put back into service without a complete inspection. However, in the case where the loss of use of the elevator creates a life-safety hazard, an attempt to put the elevator back into service may be attempted. Operating the elevator prior to inspection may cause severe damage to the elevator or its components.

The building owner should have detailed written procedures in place defining for the elevator operator/maintenance personnel which elevators in the facility are necessary from a post-earthquake life safety perspective. It is highly recommended that these procedures be in-place, with appropriate personnel training, prior to an event strong enough to trip the seismic switch.

C13.6.10.4 Retainer Plates

The use of retainer plates is a very low cost provision to improve the seismic response of elevators.

C13.6.11 Other Mechanical and Electrical Components. The material properties set forth in Item 2 of this Section are similar to those allowed in ASME BPVC and reflect the high factors of safety necessary for seismic, service, and environmental loads.

REFERENCES

- ANCO Engineers, Inc. 1983. *Seismic Hazard Assessment of Non-Structural Components—Phase I*, Final Report for National Science Foundation from ANCO Engineers, Inc., Culver City, California, September.
- American National Standards Institute/ Sheet Metal and Air Conditioning Contractors' National Association. 2000. *Seismic Restraint Manual: Guidelines for Mechanical Systems*, ANSI/SMACNA 001-2000.
- American Society of Heating, Refrigeration, and Air Conditioning Engineers. 2000. *A Practical Guide to Seismic Restraint*.
- ASTM International. 2006. *Standard Practice for Application of Ceiling Suspension Systems for Acoustical Tile and Lay-in Panels in Areas Requiring Seismic Restraint*, ASTM E580
- Bachman, R. E., and S. M. Dowty. 2008. "Nonstructural Component or Nonbuilding Structure?" *Building Safety Journal* (April-May).
- Bachman, R. E., and R. M. Drake. 1996. "A Study To Empirically Validate the Component Response Modification Factors in the 1994 NEHRP Provisions Design Force Equations for Architectural, Mechanical, and Electrical Components," letter report to the National Center for Earthquake Engineering Research, July.
- Bachman, R. E., R. M. Drake, and P. J. Richter. 1993. *1994 Update to 1991 NEHRP Provisions for Architectural, Mechanical, and Electrical Components and Systems*, letter report to the National Center for Earthquake Engineering Research, February 22.
- Badillo, H. 2003. *Seismic Fragility Testing of Suspended Ceiling Systems*, Masters Thesis, Department of Civil, Structural, and Environmental Engineering, State University of New York at Buffalo, Buffalo New York, September.
- Badillo, H., A. S. Whittaker, A. M. Reinhorn, and G. P. Cimmarello. 2006. *Seismic Fragility of Suspended Ceiling Systems*, MCEER Report-06-0001. Multidisciplinary Center for Earthquake Engineering Research, State University of New York at Buffalo.
- Badillo, H., A. S. Whittaker, and A. M. Reinhorn. 2007. "Seismic Fragility of Suspended Ceiling Systems," *Earthquake Spectra*, 23(1).
- Behr, R. A., A. Belarbi, and A. T. Brown. 1995. "Seismic Performance of Architectural Glass in a Storefront Wall System," *Earthquake Spectra*, 11(3):367-391.
- Behr, R. A., and A. Belarbi. 1996. "Seismic Tests Methods for Architectural Glazing Systems," *Earthquake Spectra*, 12(1):129-143.

- Bouwkamp, J. G., and J. F. Meehan. 1960. "Drift Limitations Imposed by Glass," *Proceedings of the Second World Conference on Earthquake Engineering*, Tokyo, Japan, 1763-1778.
- Ceiling and Interior Systems Construction Association. 2004. *Guidelines for Seismic Restraint for Direct-hung Suspended Ceiling Assemblies (zones 3-4)*.
- Ceiling and Interior Systems Construction Association. 2004. *Recommendations for Direct-hung Acoustical Tile and Lay-in Panel Ceilings (zones 0-2)*.
- Drake, R. M., and R. E. Bachman. 1996. "NEHRP Provisions for 1994 for Nonstructural Components," *ASCE Journal of Architectural Engineering*, March.
- Drake, R. M., and R. E. Bachman. 1995. "Interpretation of Instrumented Building Seismic Data and Implications for Building Codes," in *Proceedings of the 1995 SEAOC Annual Convention*.
- Drake, R. M., and R. E. Bachman. 1994. "1994 NEHRP Provisions for Architectural, Mechanical, and Electrical Components," in *Proceedings of the 5th United States National Conference on Earthquake Engineering*.
- Earthquake Engineering Research Institute. 1994. "Northridge Earthquake, January 17, 1994: Preliminary Reconnaissance Report," edited by John F. Hall, pp. 56-57. EERI, Oakland, California.
- Gates, W. E. and G. McGavin. 1998. "Lessons Learned from the 1994 Northridge Earthquake on the Vulnerability of Nonstructural Systems," in *Proceedings, Seminar on Seismic Design, Retrofit, and Performance of Nonstructural Components, ATC-29-1, January 22-23, 1998, San Francisco, California*. Applied Technology Council, Redwood City, California, pp. 93-101.
- Housner, G. W., and M. A. Haroun. 1980. "Seismic Design of Liquid Storage Tanks" in *ASCE Convention Proceedings*.
- Institute of Electrical and Electronics Engineers, Inc. 2005. *IEEE Recommended Practices for Seismic Design of Substations*, IEEE 693-2005.
- International Code Council Evaluation Service. 2007. *Seismic Qualification by Shake-table Testing of Nonstructural Components and Systems*, ICC-ES AC156. International Code Council Evaluation Service, Whittier, California.
- Kehoe, B., and M. Hachem. 2003. "Procedures for Estimating Floor Accelerations" by ATC 29-2, 2003
- Pantelides, C. P., K. Z. Truman, R. A. Behr, and A. Belarbi. 1996. "Development of a Loading History for Seismic Testing of Architectural Glass in a Shop-Front Wall System," *Engineering Structures*, 18(12):917-935.
- Unified Facilities Criteria, Department of Defense. 2007. *Seismic Design for Buildings*, United States Department of Defense, UFC 3-310-04.
- Wright, P. D. 1989. *The Development of a Procedure and Rig for Testing the Racking Resistance of Curtain Wall Glazing*, BRANZ Studey Report 17. Building Research Association of New Zealand (BRANZ).
- Yao, G. C. 2000. "Seismic Performance of Direct Hung Suspended Ceiling Systems," *Journal of Architectural Engineering*, 6(1):6-11.

Page intentionally left blank.

COMMENTARY TO CHAPTER 14, MATERIAL SPECIFIC SEISMIC DESIGN AND DETAILING REQUIREMENTS

Because seismic loading is expected to cause nonlinear behavior in structures, seismic design criteria require not only provisions to govern loading, but also provisions to define the required configurations, connections, and detailing to produce material and system behavior consistent with the design assumptions. Thus, while ASCE/SEI 7-05 is primarily a loading standard, compliance with Chapter 14, which covers material specific seismic design and detailing, is required. In general, Chapter 14 adopts material design and detailing standards developed by industry material standards organizations. These materials standards organizations maintain complete commentaries covering their standards and such material is not duplicated here.

The refinements, additions, and recommended changes to the material standards produced by the Provisions Update Committee appear in Part 1 of the 2009 *NEHRP Recommended Seismic Provisions* as exceptions to ASCE/SEI 7-05 along with associated commentary.

C14.0 SCOPE

The scoping statement in this section clarifies that foundation elements are subject to all of the structural design requirements of the standard.

C14.1 STEEL

C14.1.1 Reference Documents. This section lists a series of structural standards published by the American Institute of Steel Construction (AISC), American Iron and Steel Institute (AISI), American Society of Civil Engineers (ASCE/SEI), and Steel Joist Institute (SJI) that are to be applied in the seismic design of steel members and connections in conjunction with the requirements of ASCE/SEI 7. The AISC references are available free of charge in electronic format at www.aisc.org.

C14.1.2 Seismic Design Categories B and C. For the lower Seismic Design Categories B and C, the engineer is allowed a choice in the design of a steel lateral force resisting system. The first option is to design the structure to meet the design and detailing requirements for structures assigned to higher Seismic Design Categories, with the corresponding seismic design parameters (R , Ω_0 , and C_d). The second option is to use a lower R factor of 3 (and higher resulting base shear), an Ω_0 of 3, and a C_d value of 3 but without specific seismic design and detailing requirements. The concept of this option is that design for a higher base shear force will result in essentially elastic response that will compensate for the limited ductility of the members and connections, resulting in performance similar to that of more ductile systems.

C14.1.3 Seismic Design Categories D through F. For the higher Seismic Design Categories, the Engineer is not given a choice, but must follow the seismic design provisions of either AISC or AISI using the seismic design parameters specified for the chosen structural system. It is not considered appropriate to design structures without specific design and detailing for seismic response in these high Seismic Design Categories.

C14.1.4 Cold-Formed Steel. This section adopts two standards by direct reference: AISI NAS, *North American Specification for the Design of Cold-Formed Steel Structural Members*, and ASCE/SEI 8, *Specification for the Design of Cold Formed Stainless Steel Structural Members*.

Both of the adopted reference documents have specific limits of applicability. AISI NAS (Section A1.1) applies to the design of structural members that are cold-formed to shape from carbon or low-alloy steel sheet, strip, plate, or bar not more than one-inch in thickness. ASCE/SEI 8 (Section 1.1.1) governs the design of structural members that are cold-formed to shape from annealed and cold-rolled sheet, strip, plate, or flat bar stainless steels. Both documents focus on load-carrying members in buildings; however, allowances are made for applications in nonbuilding structures, if dynamic effects are considered appropriately.

Within each document, there are requirements related to general provisions for the applicable types of steel; design of elements, members, structural assemblies, connections, and joints; and mandatory testing. In addition, AISI NAS contains a chapter on the design of cold-formed steel structural members and connections undergoing cyclic loading. Both standards contain extensive commentaries for the benefit of the user.

C14.1.4.1 Light-Framed Cold-Formed Steel Construction. This subsection of cold-formed steel relates to light-framed construction, which is defined as a method of construction where the structural assemblies are formed primarily by a system

of repetitive wood or cold-formed steel framing members or subassemblies of these members (ASCE/SEI 7-05 Section 11.2). Not only does this subsection repeat the direct adoptions of AISI NAS and ASCE/SEI 8, but it also allows the user to choose from an additional suite of standards that address different aspects of construction, including the following:

1. AISI GP, *Standard for Cold-Formed Steel Framing— General Provisions*, applies to the design, construction, and installation of structural and non-structural cold-formed steel framing members where the specified minimum base metal thickness is between 18 mils and 118 mils (Section A1).
2. AISI WSD, *Standard for Cold-Formed Steel Framing – Wall Stud Design*, applies to the design and installation of cold-formed steel studs for both structural and non-structural walls in buildings (Section A1).
3. AISI Lateral, *Standard for Cold-Formed Steel Framing – Lateral Design*, contains design requirements for shear walls, diagonal strap bracing (as part of a structural wall), and diaphragms (Section A1).

The requirements of AISI GP apply to all light-framed cold-formed steel and, consequently, the standard is adopted by direct reference in both AISI WSD and AISI Lateral. In addition, all of these documents include commentaries to aid the user in the correct application of their requirements.

C14.1.5 Prescriptive Framing. This section adopts AISI PM, *Standard for Cold-Formed Steel Framing – Prescriptive Method for One and Two Family Dwellings*, which applies to the construction of detached one-and two-family dwellings, townhouses, and other attached single-family dwellings not more than two stories in height using repetitive in-line framing practices (Section A1). This document adopts AISI GP by direct reference and includes a commentary to aid the user in the correct application of its requirements.

C14.1.6 Steel Deck Diaphragms. Design of steel deck diaphragms is to be based upon recognized national standards or a specific testing program directed by a person experienced in testing procedures and steel deck. All fastener design values (welds, screws, power actuated fasteners, button punches) for attaching steel deck sheet to steel deck sheet or for attaching the steel deck to the building framing members must be per recognized national design standards or specific steel deck testing programs. All steel deck diaphragm and fastener design properties must be approved for use by the authorities in whose jurisdiction the construction project occurs. Steel deck diaphragm in-plane design forces (seismic, wind, or gravity) must be determined per ASCE/SEI 7-05 Section 12.10.1. Steel deck manufacturer test reports prepared in accordance with this provision can be used where adopted and approved by the authority having jurisdiction for the building project. The diaphragm design manual produced by the Steel Deck Institute (2004) is also a potential reference for design values.

Steel deck is assumed to have a corrugated profile consisting of alternating up and down flutes that are manufactured in various widths and heights. Use of flat sheet metal as the overall floor or roof diaphragm is permissible where designed by engineering principles, but is beyond the scope of this section. Flat or bent sheet metal may be used as closure pieces for small gaps or penetrations or for shear transfer over short distances in the steel deck diaphragm where diaphragm design forces are considered.

Steel deck diaphragm analysis must include design of chord members at the perimeter of the diaphragm and around interior openings in the diaphragm. Chord members may be steel beams attached to the underside of the steel deck designed for a combination of axial loads and bending moments due to acting gravity and lateral loads.

Where diaphragm design loads exceed the bare steel deck diaphragm design capacity, then either horizontal steel trusses or a structurally designed concrete topping slab placed over the steel deck must be provided to distribute lateral forces. Where horizontal steel trusses are used, the steel deck must be designed to transfer diaphragm forces to the steel trusses. Where a structural concrete topping over the steel deck is used as the diaphragm, the diaphragm chord members at the perimeter of the diaphragm and edges of interior openings must be either: (a) designed flexural reinforcing steel placed in the structural concrete topping or (b) steel beams located under the steel deck with connectors (that provide a positive connection) as required to transfer design shear forces between the concrete topping and steel beams.

C14.1.7 Steel Cables. These provisions reference ASCE/SEI 19-96, *Structural Applications of Steel Cables for Buildings*, for the determination of the design strength of steel cables. ASCE/SEI 19 uses service level load combinations with a safety factor relative to the cable design strength. The service level load combinations specified in ASCE/SEI 19 are adjusted in two ways. First, the prestress loading is multiplied by a factor of 1.1 to account for any over prestressing that may occur in the field. Second, the safety factor for load combinations including seismic effects is reduced from 2.0 to 1.5 to account for the dynamic nature of seismic loading and the ductility of the system. While T3 and T4 in ASCE/SEI 19 may be calculated using either wind or seismic loads, the modifications of this section apply only to load combinations including seismic loadings.

C14.1.8 Additional Detailing Requirements for Steel Piles in Seismic Design Categories D through F. Steel piles used in higher Seismic Design Categories are expected to yield just under the pile cap or foundation due to combined bending and

axial load. Design and detailing requirements of AISC 341 for H-piles are intended to produce stable plastic hinge formation in the piles. Since piles can be subjected to tension due to overturning moment, mechanical means to transfer such tension must be designed for the required tension force, but not less than 10 percent of the pile compression capacity.

C14.2 CONCRETE

The section adopts ACI 318-05, *Building Code Requirements for Structural Concrete* (ACI 318), by reference for structural concrete design and construction. In addition, modifications to ACI 318 are made to coordinate the provisions of that material design standard with the provisions of ASCE/SEI 7.

C14.2.2.1 ACI 318 Section 7.10. The reinforcement details for ties in compression members prescribed in ACI 318 Section 7.10.5 are appropriate for SDC A and B structures. This modification prescribes additional details for ties around anchor bolts of structures assigned to SDC C, D, E, or F.

C14.2.2.2 ACI 318 Section 10.5. This provision affects ordinary moment frames. It is intended to improve continuity, and thereby lateral force resistance and structural integrity, compared to that of frames designed to the provisions of Chapters 1 through 18 of ACI 318 only. The provision does not apply to slab-column moment frames.

C14.2.2.3 ACI 318 Section 11.11. This requirement is intended to provide additional toughness to resist shear for columns of frames in SDC B. Otherwise the proportions of those columns make them more susceptible to shear failure under earthquake loading.

C14.2.2.4 Definitions. The first four definitions relate the wall types of ASCE/SEI 7-05 with detailing requirements of ACI 318 and distinguish between ordinary reinforced concrete structural walls and ordinary precast structural walls. These definitions are essential to the proper interpretation of the R and C_d factors for each wall type specified in Table 12.2-1.

A wall pier is recognized as a separate category of structural element in this document but not in ACI 318.

C14.2.2.5 Scope. ACI 318 uses the terminology of low, moderate, and high seismic risk for structures assigned to SDC A and B, SDC C, and SDC D through F, respectively. The modifications of this provision show how the ACI 318 provisions should be interpreted for consistency with the ASCE/SEI 7-05 provisions.

C14.2.2.6 Reinforcement in Members Resisting Earthquake-Induced Forces. ACI 318 does not allow the use of prestressing tendons in special and intermediate moment frames. This provision and ASCE/SEI 7-05 Sections 14.2.2.7 and 14.2.2.8 impose conditions that have been demonstrated to permit the safe use of such tendons.

These provisions are intended to apply to frames containing unbonded tendons only. The average prestress in plastic hinge regions is restricted to limit the strain in the prestressing steel under the design displacement to not greater than 1 percent. The strain in the prestressing steel at the design displacement should be calculated considering the anticipated inelastic mechanism of the structure.

C14.2.2.7 Anchorages for Unbonded Post-tensioning Tendons. Fatigue testing for 50 cycles of loading between 40 and 80 percent of the specified tensile strength of the prestressing strand has been an industry practice of long standing (ACI 423.6, *Specification for Unbonded Single-Strand Tendons*). The 80 percent limit is increased to 85 percent for seismic applications in order to correspond to a 1 percent limit, and therefore the effective start of yielding, in the prestressing steel. Testing over this range of stress conservatively simulates the effect of a severe earthquake on structures prestressed in accordance with the requirements of ASCE/SEI 7-05 Sections 14.2.2.6 and 14.2.2.8.

C14.2.2.8 Flexural Members of Special Moment Frames. The restrictions on the flexural strength provided by the tendons are based on the results of analytical and experimental studies (Ishizuka and Hawkins, 1987; Park and Thompson, 1977). Although satisfactory seismic performance can be obtained with greater amounts of prestressing steel, this restriction is needed to allow the use of the same response modification and deflection amplification factors as those specified for special moment frames without prestressing steel.

C14.2.2.9 Wall Piers and Wall Segments. Wall piers are typically segments between openings in walls that are thin in the direction normal to the face of the wall. In current practice these elements are often not regarded as columns or as part of the special structural walls. If not properly reinforced these elements are vulnerable to shear failure, and that failure prevents the wall from developing the assumed flexural hinging. ACI 318 Section 21.7.10 is written specifically to preclude such pre-emptive shear failure. The required shear strength in ACI 318 Section 21.4.5.1 is based on the probable shear strength, V_e , under the probable moment, M_{pr} . Wall segments with a horizontal length-to-thickness ratio less than 2.5 and a clear height-to-length ratio of at least 2 are required to be designed as columns in compliance with ACI 318 Section 21.4 if they are used as part of the lateral-force-resisting system even though the shortest cross-sectional dimension may be less than 12 inches in violation of Section 21.4.1.1. Such wall segments may be designed to comply with ACI 318 Section 21.11 if they are not

used as part of the lateral-force-resisting system. Wall segments with a horizontal length-to-thickness ratio larger than or equal to 2.5, which do not meet the definition of wall piers (ASCE/SEI 7-05 Section 14.2.2.4), must be designed as special structural walls or as portions of special structural walls in full compliance with ACI 318 Section 21.7.

C14.2.2.12 Members Not Designated as Part of the Lateral-Force-Resisting System. ACI 318 Section 21.4.3.2 permits lap splices only within the center half of the column. Section 21.11.2 applies where the magnitude of the moments induced in the column by the design displacement are explicitly checked. Section 21.11.3 applies where the effects of the design displacement are not explicitly checked. Section 21.11.2.2, if not modified, would permit lap splices to be placed at any location over the height of the column if the column is expected to yield. If, however, the column is not expected to yield the wording effectively requires the splice to be located near mid-height. This is not rational and the modification results in a more rational provision.

C14.2.2.13 Columns Supporting Reactions from Discontinuous Stiff Members. Discontinuous shear walls and other stiff members can impose large axial forces on supporting columns. The specified transverse reinforcement is to improve column toughness under anticipated seismic demands.

C14.2.2.14 Intermediate Precast Structural Walls. ACI 318 Section 21.13 imposes requirements on precast walls for moderate seismic risk applications. The intent is to produce ductile behavior by yielding of the steel elements or reinforcement between panels or between panels and foundations. The 2003 IBC restricted yielding to steel reinforcement because of concern that steel elements in the body of a connection could fracture due to strain demands.

Several steel element connections have been tested under simulated seismic loading and the adequacy of their load-deformation characteristics and strain capacity of yield has been demonstrated (Schultz and Magana, 1996). One such connection was used in the five-story building test that was part of the PRESSS Phase 3 research. The connection was used to provide damping and energy dissipation, and demonstrated a very large strain capacity (Nakaki et al., 2001). Since then several other steel element connections have been developed that can achieve similar results (Banks and Stanton, 2005; Nakaki et al., 2005). In view of these results it is appropriate to allow yielding in steel elements that have been shown experimentally to have adequate strain capacity to maintain at least 80 percent of their yield force of through the full design displacement of the structure. This provision requires the designer to determine the deformation in the connection corresponding to the earthquake design displacement, and then to check for experimental data that the connection type used can accommodate that deformation without significant strength degradation.

The wall pier requirements in the modified ACI 318 Section 21.13.5 are less stringent than those for wall piers for special structural walls as specified in the modified Section 21.7.10. Where intermediate precast structural walls are used in SDCs D, E and F, wall piers should satisfy the requirements of ASCE/SEI 7-05 Section 14.2.2.9 rather than 14.2.2.14.

C14.2.2.15 Detailed Plain Concrete Shear Walls. Design requirements for plain masonry walls have existed for many years, and the competing type of concrete construction is the plain concrete wall. To allow the use of such walls as the lateral-force-resisting system in SDC A and B, this provision requires such walls to contain at least the minimal reinforcement specified in ACI 318 Section 22.6.7.2.

C14.2.2.16 Plain Concrete in Structures Assigned to Seismic Design Category C, D, E, or F. Modifications are made to ACI 318 Section 22.10 that restrict markedly the use of ordinary and detailed structural plain concrete walls in SDC C, D, E, and F.

C14.2.2.17 General Requirements for Anchoring to Concrete. ACI 318 uses the terminology of regions of moderate or high seismic risk and structures assigned to intermediate or high seismic performance or design categories. In this modification, the only changes to ACI 318 in Sections D3.3.3 through D3.3.4 are the replacement of that terminology with the SDC terminology.

There are two changes to the provisions in ACI 318 Section D3.3.5. The first is the use of the SDC terminology, and the second is the addition of the last phrase of the provision referring to the minimum design strength of the anchors. The last phrase requires an anchor strength that is at least the maximum likely Ω_o value (2.5) times the design force calculated as being transmitted to the attachment by the lateral-force-resisting system.

C14.2.2.18 Strength Requirements for Anchors. ACI 318 requires laboratory testing to establish the strength of anchor bolts greater than 2 inches in diameter or exceeding 25 inches in tensile embedment depth. This modification makes the ACI 318 equation giving the basic concrete breakout strength of a single anchor in tension in cracked concrete applicable irrespective of the anchor bolt diameter and tensile embedment depth.

Korean Power Engineering (KPE) has made tension tests on anchors with diameters up to 4.25 inches and embedment depths up to 45 inches and found that the diameter and embedment depth limits of ACI 318 Section D4.2.2 for the design procedure for anchors in tension (Section D5.2) can be eliminated. KPE has also made shear tests on anchors with diameters up to 3.0

inches and embedment depths as large as 30 inches and found no effect of the embedment depth on shear strength. However, the diameter tests showed that the basic shear breakout strength equation (ACI 318 Section D-24) needed some modification for the complete elimination of the 2 inch limit to be fully appropriate. Analytical work performed at the University of Stuttgart supports the need for some modification to the ACI 318 Equation D-24. Changes consistent with the Korean and Stuttgart findings have already been made to the FIB Design Guide for anchors and a change proposal consistent with those changes has been submitted to ACI 318 for consideration.

C14.2.3.1.2 Reinforcement for Uncased Concrete Piles (SDC C): The transverse reinforcing requirements in the potential plastic hinge zone of uncased concrete piles in Seismic Design Category C is a selective composite of two ACI 318 requirements. In the potential plastic hinge region of an intermediate moment-resisting concrete frame column, the transverse reinforcement spacing is restricted to the least of: (a) 8 times the diameter of the smallest longitudinal bar, (b) 24 times the diameter of the tie bar, (c) one-half the smallest cross-sectional dimension of the column, and (d) 12 inches. Outside of the potential plastic hinge region of a special moment-resisting frame column, the transverse reinforcement spacing is restricted to the smaller of: 6 times the diameter of the longitudinal column bars and 6 inches.

C14.2.3.1.5 Reinforcement for Precast Nonprestressed Concrete Piles (SDC C): Transverse reinforcement requirements inside and outside of the plastic hinge zone of precast nonprestressed piles are clarified. The transverse reinforcement requirement in the potential plastic hinge zone is a composite of two ACI 318 requirements (see Section C14.2.3.1.2). Outside of the potential plastic hinge region the eight longitudinal-bar-diameter spacing is doubled. The maximum 8-in. tie spacing comes from current building code provisions for precast concrete piles.

C14.2.3.1.6 Reinforcement for Precast Prestressed Piles (SDC C): The transverse and longitudinal reinforcing requirements given in ACI 318 Chapter 21 were never intended for slender precast prestressed concrete elements and will result in unbuildable piles. The requirements are based on the 1993 *Recommended Practice for Design, Manufacture and Installation of Prestressed Concrete Piling* by the PCI Committee on Prestressed Concrete Piling.

ASCE/SEI 7-05 Equation 14.2-1, originally from ACI 318, has always been intended to be a lower-bound spiral reinforcement ratio for larger diameter columns. It is independent of the member section properties and therefore can be applied to large or small diameter piles. For cast-in-place concrete piles and precast prestressed concrete piles, the resulting spiral reinforcing ratios from this formula are considered to be sufficient to provide moderate ductility capacities.

Full confinement per Equation 14.2-1 is required for the upper 20 feet of the pile length where curvatures are large. The amount is relaxed by 50 percent outside of that length in view of lower curvatures and in consideration of confinement provided by the soil.

C14.2.3.2.5 Reinforcement for Precast Concrete Piles (SDC D through F): The transverse reinforcement requirements for precast nonprestressed concrete piles are taken from current building code requirements and are intended to provide ductility in the potential plastic hinge zones.

C14.2.3.2.6 Reinforcement for Precast-Prestressed Piles (SDC D through F): The last paragraph provides minimum transverse reinforcement outside of the zone of prescribed ductile detailing.

C14.3 COMPOSITE STEEL AND CONCRETE STRUCTURES

This section provides guidance on the design of composite and hybrid steel-concrete structures. Composite structures are defined as those incorporating structural elements made of steel and concrete portions connected integrally throughout the structural element by mechanical connectors, bond, or both. Hybrid structures are defined as consisting of steel and concrete structural elements connected together at discrete points. Composite and hybrid structural systems mimic many of the existing steel (moment and braced frame) and concrete (moment frame and wall) configurations, but are given their own design coefficients and factors in Table 12.2-1. Their design is based on the same ductility and energy dissipation concepts used in conventional steel and reinforced concrete structures, but requires special attention to the interaction of the two materials as it affects the stiffness, strength, and inelastic behavior of the members, connections, and systems.

C14.3.1 Reference Documents. Seismic design for composite structures assigned to Seismic Design Category D, E, or F is governed primarily by *Part II: Composite Structural Steel and Reinforced Concrete Buildings* of ANSI/AISC 341. Part II of ANSI/AISC 341 is less prescriptive than Part I and provides flexibility for designers to utilize analytical tools and results of research in their practice. Composite structures assigned to Seismic Design Category A, B, or C may be designed according to principles outlined in ANSI/AISC 360 and ACI 318. ACI 318 and ANSI/AISC 360 provide little guidance on connection design; therefore, designers are encouraged to review ANSI/AISC 341 Part II for guidance on the design of joint areas. Differences between older AISC and ACI provisions for cross-sectional strength for composite columns have been minimized by changes in the latest ANSI/AISC 360. However, there is not uniform agreement between the provisions in

ACI 318 and ANSI/AISC 360 regarding detailing, limits on material strengths, stability, and shear design for composite columns. The composite design provisions in ANSI/AISC 360 are considered to be current.

C14.3.2 Metal-Cased Concrete Piles. Design of metal-cased concrete piles, which are analogous to circular concrete filled tubes, is governed by ASCE/SEI 7-05 Sections 14.2.3.1.3 and 14.2.3.2.4. The intent of these provisions is to require metal-cased concrete piles to have confinement and protection against long-term deterioration comparable to that for uncased concrete piles.

C14.4 MASONRY

Seismic design for masonry structures is governed primarily by two documents produced by the Masonry Standards Joint Committee (MSJC): ACI 530-05/ASCE/SEI 5-05/TMS 402-5, *Building Code Requirements for Masonry Structures* (the MSJC Code), and ACI 530.1-05/ASCE/SEI 6-05/TMS 602-05, *Specification for Masonry Structures* (the MSJC Specification).

C14.4.2 R Factors. Where intermediate and special reinforced masonry shear walls are designed using the allowable-stress provisions of the MSJC Code, these additional requirements are intended to produce a level of inelastic flexural deformation capacity consistent with that of intermediate and special reinforced masonry shear walls designed using the strength-design provisions of the MSJC Code. The additional requirements are discussed in ASCE/SEI 7-05 Section C14.4.6.

C14.4.3 Classification of Shear Walls. Section 1.14 of the 2005 MSJC Code can be interpreted as permitting, in SDCs A and B, masonry walls that need not be considered part of the lateral-force-resisting system and that do not need to be isolated. ASCE/SEI 7-05 Section 14.4.3 is intended to preclude that interpretation.

C14.4.5.1 Separation Joints. This section is intended to address force transfer across interfaces between masonry and other materials, but it is redundant. Article 3.2B of the MSJC Specification requires that the interface between concrete and masonry be cleaned and acceptable for laying of units. Further, Section 1.9.4.2.4 of the 2005 MSJC Code addresses the design and transfer of shear at interfaces, and Section 1.7.5.2 requires that a load path and force transfer between a foundation and the masonry above be maintained.

C14.4.5.2 Flanged Shear Walls. Section 1.9.4.2.3 of the MSJC Code contains the compression requirement (lesser of 6 times the flange thickness or the actual flange). The principal effect of the tension provision in ASCE/SEI 7-05 Section 14.4.5.2 is to establish the amount of tensile reinforcement used in calculating flexural capacity and maximum permitted reinforcement, but this provision is not well established technically. Research in masonry, and analogous design provisions for concrete (ACI 318 Section 21.7.5.2), suggest that effective flange widths in tension are more logically related to the total wall height rather than the floor-to-floor height. The 2005 MSJC Code and ASCE/SEI 7-05 are working together to resolve this issue and add appropriate requirements to TMS 402.

C14.4.6 Modifications to Chapter 2 of ACI 530/ASCE/SEI 5/TMS 402. Chapter 2 of the MSJC Code deals with allowable-stress design.

C14.4.6.1 Stress Increase. The MSJC Code permits allowable stresses to be increased by one-third for allowable-stress loading conditions that include wind or earthquake, provided that the legally adopted building code so permits. While the alternate allowable-stress loading combinations of the 2006 IBC do so permit, the allowable-stress loading combinations of ASCE/SEI 7-05 do not.

C14.4.6.2 Reinforcement Requirements and Details.

C14.4.6.2.1 Reinforcing Bar Size Limitations. The intent of this requirement is to prevent splitting of masonry due to the presence of reinforcement. A similar requirement is appears in Chapter 3 (Strength Design) of the 2005 MSJC Code. The MSJC is working to move that requirement to Chapter 1 (General Requirements) so that it would apply to all masonry construction.

C14.4.6.2.2 Splices. In general, the first portion of this section, which prohibits splices in plastic hinge zones, is intended to produce adequate inelastic deformation capacity in those regions. In general, the presence of splices in plastic hinge zones reduces inelastic deformation capacity because the area of steel is doubled at the splice, reducing the extent of yielding. However, there is some controversy concerning the technical validity and necessity for this requirement for masonry walls. Similar requirements apply to plastic hinge zones of reinforced concrete frames, they do not apply to plastic hinge zones of reinforced concrete walls. Also, this requirement does not distinguish between shear-critical and flexurally dominated shear walls. The MSJC is continuing to discuss related requirements for flexurally dominated, highly ductile shear walls.

The remaining portions of this section (requirements for splices) are intended to provide adequate capacity of welded splices and mechanical connections. The MSJC is developing similar provisions.

C14.4.6.2.3 Maximum Area of Flexural Tensile Reinforcement. The intent of this section is to produce adequate inelastic flexural deformation capacity in flexurally dominated masonry shear walls by placing an upper limit on flexural reinforcement, so that behavior is dominated by yielding of reinforcement rather than by crushing of the compression toe. Similar provisions appear in Chapter 3 (Strength Design) of the MSJC Code and are being developed for Chapter 2 (Allowable-Stress Design).

C14.4.7 Modifications to Chapter 3 of ACI 530/ASCE/SEI 5/TMS 402.

C14.4.7.2 Splices in Reinforcement. See Section C14.4.6.2.2.

C14.4.7.3 Coupling Beams. The intent of this requirement is to produce adequate inelastic flexural deformation capacity in coupling beams. The section is somewhat redundant with Section 3.1.3 of the MSJC Code, which requires capacity design of masonry elements for shear.

C14.4.7.4 Deep Flexural Members. The intent of this requirement is to require that the design of deep flexural members correctly addresses the presence of distributed flexural reinforcement in capacity design for shear, and that crack widths are adequately controlled.

C14.4.7.5 Shear Keys. The intent of this requirement is to increase resistance to sliding shear at the foundation level of flexurally dominated masonry shear walls. The original proposal was based on laboratory research (Leiva et al., 1990) involving isolated shear walls. In subsequent research (Seible et al., 1993), flanged walls without shear keys did not show sliding.

C14.4.7.6 Anchoring to Masonry. The intent of this requirement is to guard against brittle failure of masonry anchorages that are part of the seismic force-resisting system.

C14.4.7.7 Anchor Bolts. ASCE/SEI 7-05 Sections 14.4.7.7 and 14.4.7.8 augment the current anchor bolt provisions of MSJC Code Chapter 3 (Strength Design) to address pryout and to include an appropriate ϕ factor.

C14.4.8 Modifications to Chapter 6 of ACI 530/ASCE/SEI 5/TMS 402. There is an apparent difference in the treatment of corrugated sheet metal anchors in different chapters of the MSJC Code. Chapter 6 of that document, dealing with masonry veneer, permits corrugated sheet-metal anchors. Chapters 2 and 3 of that document do not permit multi-wythe, noncomposite masonry (functionally identical to veneer) to be bonded by corrugated sheet-metal anchors.

C14.4.9 Modifications to ACI 530.1/ASCE/SEI 6/TMS 602.

C14.4.9.1 Construction Procedures. This requirement was introduced originally as a result of the TCCMaR program as a way to address volume loss as a result of plastic shrinkage of grout. The original provision required the use of a particular admixture (Sika's Grout Aid®) in the grout. The MSJC Specification requires both consolidation and reconsolidation of masonry grout, which in combination with today's masonry construction materials can minimize grout shrinkage without the requirement of a proprietary grout admixture available from a single source.

C14.5 WOOD

C14.5.1 Reference Documents. Two national consensus standards are adopted for seismic design of engineered wood structures: the *National Design Specification* (NDS), and the *Special Design Provisions for Wind and Seismic* (SDPWS) Supplement to the NDS. Both of these standards, published by the American Forest and Paper Association (AF&PA), are presented in dual allowable stress design (ASD) and load and resistance factor design (LRFD) formats. Both standards reference a number of secondary standards for related items such as wood materials and fasteners. SDPWS addresses general principles and specific detailing requirements for shear wall and diaphragm design and provides tabulated nominal unit shear capacities for shear wall and diaphragm sheathing and fastening. The balance of member and connection design is to be in accordance with the NDS. A commentary to the NDS is published by AF&PA (2005b); commentary to the SDPWS is included in the SDPWS publication (AF&PA, 2005c).

C14.5.2 Framing. This section provides specific guidance on two general topics related to detailing. First, vertical loads on columns and posts must be transferred in and out by end bearing only or by connectors only; mixing the capacity of end bearing and connectors is prohibited due to a potential lack of deformation compatibility. Second, load path continuity for top plates, which often function as collectors, is addressed.

C14.5.3.1 ASCE/SEI 7-05 Modification to SDPWS Section 4.3.3.2, Summing Shear Capacities. This amendment to the SDPWS does not provide additional clarity; therefore, it is expected to be deleted ASCE/SEI 7-10.

REFERENCES

- American Forest and Paper Association. 2005a. *National Design Specification (NDS) for Wood Construction*, ANSI/AF&PA NDS-2005. AF&PA, Washington, D.C.
- American Forest and Paper Association. 2005b. *National Design Specification Commentary*, 2005 ed. AF&PA, Washington, D.C.
- American Forest and Paper Association. 2005c. *Special Design Provisions for Wind and Seismic (Wind & Seismic)*, ANSI/AF&PA SDPWS-2005. AF&PA, Washington, D.C.
- American Institute of Timber Construction. 2005. *Timber Construction Manual*, 5th ed. John Wiley and Sons, Inc.
- APA - The Engineered Wood Association. 2004. *Diaphragms and Shear Walls Design/Construction Guide*, L350. APA, Tacoma, Washington.
- APA - The Engineered Wood Association. 1994. *Northridge California Earthquake*, T94-5. APA, Tacoma, Washington.
- Applied Technology Council. 1981. *Guidelines for the Design of Horizontal Wood Diaphragms*, ATC-7. ATC, Redwood City, California.
- Banks, G., and J. Stanton. 2005. "Panel-to-Panel Connections for Hollow-Core Shear Walls Subjected to Seismic Loading," in *Proceedings, 2005 PCI Convention*, Palm Springs, California.
- Breyer et al. 2006. *Design of Wood Structures ASD/LRFD*, Sixth Edition. McGraw-Hill Book Company, New York, New York.
- Building Seismic Safety Council. 2003. *NEHRP Recommended Provisions for Seismic Regulations for New Buildings and Other Structures*, FEMA 450. Federal Emergency Management Agency, Washington, D.C.
- Canadian Wood Council. 2005. *Wood Design Manual 2005*. Canadian Wood Council, Ottawa.
- Canadian Wood Council. 1995. *Wood Reference Handbook*. Canadian Wood Council, Ottawa.
- Cobeen, K. 2004. "Recent developments in the Seismic Design and Construction of Woodframe Buildings," Chapter 18 of *Earthquake Engineering from Engineering Seismology to Performance-Based Engineering*, edited by Yousef Bozorgia and Vitelmo Bertero. CRC Press, LLC, Boca Raton, Florida.
- Consortium of Universities for Research in Earthquake Engineering. 2004. *Recommendations for Earthquake Resistance in the Design and Construction of Woodframe Buildings*, CUREE W-30. CUREE, Richmond, California.
- Department of the Army, Navy, and Air Force. 1992. *Seismic Design for Buildings*, TM5-809-10 (Tri-Services Manual). U.S. Government Printing Office, Washington, D.C.
- Dolan, J. D. 2003. "Wood Structures," Chapter 15 of *Earthquake Engineering Handbook*, edited by Wai-Fah Chen and Charles Scawthorn. CRC Press, LLC, Boca Raton, Florida.
- Earthquake Engineering Research Institute. 1996. "Northridge earthquake reconnaissance report," *Earthquake Spectra*, Chapter 6 of Supplement C to Volume 11.
- Faherty, Keith F., and T. G. Williamson. 1989. *Wood Engineering and Construction Handbook*. McGraw-Hill, New York, New York.
- Federal Emergency Management Agency. 2005. *Coastal Construction Manual*, Third Edition, FEMA 55. FEMA, Washington, D.C.
- Forest Products Laboratory. 1986. *Wood: Engineering Design Concepts*. Materials Education Council, The Pennsylvania State University, University Park.
- Goetz, Karl-Heinz, Dieter Hoor, Karl Moehler, and Julius Natterer. 1989. *Timber Design and Construction Source Book: A Comprehensive Guide to Methods and Practice*. McGraw-Hill, New York, New York.
- Hoyle and Woeste. 1989. *Wood Technology and Design of Structures*. Iowa State University Press.
- International Code Council. 2006. "ICC Standard on the Design and Construction of Log Structures," Third Draft. ICC, Country Club Hills, Illinois.
- Ishizuka, T., and N. M. Hawkins. 1987. *Effect of Bond Deterioration on the Seismic Response of Reinforced and Partially Prestressed Concrete Ductile Moment Resistant Frames*, Report SM 87-2. Department of Civil Engineering, University of Washington, Seattle.
- Karacabeyli, E., and M. Popovsky. 2003. "Design for Earthquake Resistance," Chapter 15 of *Timber Engineering*, edited by H. Larsen & S. Thelandersson. John Wiley & Sons.
- Keenan, F. J. 1986. *Limit States Design of Wood Structures*. Morrison Hershfield Limited.

-
- Masonry Standards Joint Committee (MSJC). 2005a. *Building Code Requirements for Masonry Structures*, ACI 530-05/ASCE/SEI 5-05/TMS 402-5.
- Masonry Standards Joint Committee. 2005b. *Specification for Masonry Structures*, ACI 530.1-05/ASCE/SEI 6-05/TMS 602-05.
- Nakaki, S., R. Becker, M. G. Oliva, and D. Paxson. 2005. "New Connections for Precast Wall Systems in High Seismic Regions," in Proceedings, 2005 PCI Convention, Palm Springs, California.
- Nakaki, S., J. F. Stanton, and S. Sritharan. 2001. "The PRESSS Five-Story Precast Concrete Test Building, University of California, San Diego, La Jolla, California," *PCI Journal*, 46(5):20-26.
- Park, R., and K. J. Thompson. 1977. "Cyclic Load Tests on Pretressed and Partially Prestressed Beam-Column Joints," *PCI Journal*, 22(3):84-110.
- Schultz, A. E., and R. A. Magana. 1996. "Seismic Behavior of Connections in Precast Concrete Walls," *Proceedings, Mete A. Sozen Symposium*, SP-162, pp. 273-311. American Concrete Institute, Farmington Hills, Michigan.
- Steel Deck Institute. 2004. *Diaphragm Design Manual*, 3rd Edition, No. DDMO3. SDI, Fox River Grove, Illinois.
- Structural Engineers Association of California. 1999. *Recommended Lateral Force Requirements and Commentary*. SEAOC, Sacramento, California.
- Structural Engineers Association of Northern California. 2005. *Guidelines for Seismic Evaluation and Rehabilitation of Tilt-up Buildings and Other Rigid Wall/Flexible Diaphragm Structures*. SEAONC, Sacramento, California.
- Sherwood and Stroh. 1989. "Wood-Frame House Construction" in *Agricultural Handbook 73*. U.S. Government Printing Office, Washington, D.C.
- Somayaji, Shan. 1992. *Structural Wood Design*. West Publishing Co., St. Paul, Minnesota.
- Stalnaker, Judith J., and E. C. Harris. 1996. *Structural Design in Wood*, Second Edition. McGraw-Hill, New York, New York.
- U.S. Department of Agriculture, National Oceanic and Atmospheric Administration. 1971. *San Fernando, California, Earthquake of February 9, 1971*. NOAA, Washington, D.C.

Page intentionally left blank.

COMMENTARY TO CHAPTER 15, SEISMIC DESIGN REQUIREMENTS FOR NONBUILDING STRUCTURES

C15.1.1 Nonbuilding Structures. Building codes traditionally have been perceived as minimum standards for the design of nonbuilding structures, and building code compliance of these structures is required by building officials in many jurisdictions. However, requirements in the industry reference documents are often at odds with building code requirements. In some cases, the industry documents need to be altered while in other cases the building codes need to be modified. Registered design professionals are not always aware of the numerous accepted documents within an industry and may not know whether the accepted documents are adequate. The intent of Chapter 15 of the standard is to bridge the gap between building codes and existing industry reference documents.

Differences between the ASCE/SEI 7-05 design approaches for buildings and industry document requirements for steel multi-legged water towers (Figure C15.1-1) are representative of this inconsistency. Historically, such towers have performed well when properly designed in accordance with American Water Works Association (AWWA) standards and industry practices. Those standards and practices differ from the ASCE/SEI 7-05 treatment of buildings in that tension-only rods are allowed, upset rods are preloaded at the time of installation, and connection forces are not amplified.



Figure C15.1-1 Steel multi-legged water tower.

Chapter 15 also provides an appropriate link so that the industry reference documents can be used with the seismic ground motions established in the standard. It should be noted that some nonbuilding structures are very similar to buildings and can be designed employing sections of the standard directly, whereas other nonbuilding structures require special analysis unique to the particular type of nonbuilding structure.

Note that building structures, vehicular bridges, electrical transmission towers, hydraulic structures (e.g., dams), buried utility lines and their appurtenances, and nuclear reactors are excluded from the scope of the nonbuilding structure requirements. The excluded structures are covered by other well established design criteria (e.g., electrical transmission towers and vehicular bridges), are not under the jurisdiction of local building officials (e.g., nuclear reactors, and dams), or require technical considerations beyond the scope of the standard (e.g., buried utility lines and their appurtenances).

C15.1.2 Design. Nonbuilding structures and building structures have much in common with respect to design intent and expected performance, but there are also important differences. Chapter 15 relies on other portions of the standard where possible and provides special notes where necessary.

There are two types of nonbuilding structures: those with structural systems similar to buildings, and those with structural systems not similar to buildings. Specific requirements for these two cases appear in Sections 15.5 and 15.6.

C15.1.3 Structural Analysis Procedure Selection. Nonbuilding structures that are similar to buildings are subject to the same analysis procedure limitations as building structures. Nonbuilding structures that are not similar to buildings are subject to those limitations and are subject to procedure limitations prescribed in applicable specific reference documents.

For many nonbuilding structures supporting flexible system components, such as pipe racks (Figure C15.1-2), the supported piping and platforms generally are not regarded as rigid enough to redistribute seismic forces to the supporting frames.



Figure C15.1-2 Steel pipe rack.

For nonbuilding structures supporting rigid system components, such as steam turbine generators (STGs) and heat recovery steam generators (HRSGs) (Figure C15.1-3), the supported equipment, ductwork, and other components (depending on how they are attached to the structure) may be rigid enough to redistribute seismic forces to the supporting frames. Torsional effects may need to be considered in such situations.

Section 12.6 presents seismic analysis procedures for building structures based on the Seismic Design Category; the fundamental period, T ; and the presence of certain horizontal or vertical irregularities in the structural system. Where the fundamental period is greater than or equal to $3.5T_s$ (where $T_s = S_{D1}/S_{DS}$), the use of the equivalent lateral force procedure is not permitted in Seismic Design Categories D, E, and F. This requirement is based on the fact that, unlike the dominance of the first mode response in case of buildings with lower first mode period, higher vibration modes do contribute more significantly in situations when the first mode period is larger than $3.5T_s$. For buildings that exhibit classic flexural deformation patterns (such as slender shear wall or braced frame systems), the second mode frequency is at least 3.5 times the first mode frequency, so where the fundamental period exceeds $3.5T_s$, the higher modes will have larger contributions to the total response as they occur near the peak of the design response spectrum

It follows that dynamic analysis (modal response spectrum analysis, or response-history analysis) is required for building-like nonbuilding structures if the first mode period is larger than $3.5T_s$ and that the equivalent lateral force analysis is sufficient for nonbuilding structures that respond as single-degree-of-freedom systems such as single-pedestal elevated water tanks.

The recommendations for nonbuilding structures provided below are intended to supplement the designer's judgment and experience. The designer is given considerable latitude in selecting a suitable analysis method for nonbuilding structures.



Figure C15.1-3 Heat recovery steam generators.

Building-like Nonbuilding Structures. Table 12.6-1 is used in selecting analysis methods for building-like nonbuilding structures, but, as illustrated in the following three conditions, the relevance of key behavior must be considered carefully:

1. Irregularities: Table 12.6-1 requires dynamic analysis for Seismic Design Category D, E, and F structures having certain horizontal or vertical irregularities. Some of these building irregularities (defined in Section 12.3.2) are relevant to nonbuilding structures. The weak-and soft-story vertical irregularities (Types 1a, 1b, 5a, and 5b of Table 12.3-2) are pertinent to the behavior of building-like nonbuilding structures. Other vertical and horizontal irregularities may or may not be relevant as described below.
 - a. Horizontal irregularities: Horizontal irregularities of Type 1a and 1b affect the choice of analysis method, but these irregularities apply only where diaphragms are rigid or semirigid and some building-like nonbuilding structures have either no diaphragms or flexible diaphragms.
 - b. Vertical irregularities: Vertical irregularity Type 2 is relevant where the various levels actually support significant loads. Where a building-like nonbuilding structure supports significant mass at a single level, while other levels support small masses associated with stair landings, access platforms, and so forth, dynamic response will be dominated by the first mode, so the equivalent lateral force procedure may be applied. Vertical irregularity Type 3 addresses large differences in the horizontal dimension of the seismic force-resisting system in adjacent stories, since the resulting stiffness distribution can produce a fundamental mode shape unlike that assumed in the development of the equivalent lateral force procedure. Since the concern relates to stiffness distribution, it is the horizontal dimension of the seismic force-resisting system, not of the overall structure, that is important.
2. Arrangement of supported masses: Even where a nonbuilding structure has building-like appearance, it may not behave like a building, depending on how masses are attached. For example, the response of nonbuilding structures with suspended vessels and boilers cannot be determined reliably using the equivalent lateral force procedure because of the pendulum modes associated with the significant mass of the suspended components. The resulting pendulum modes, while potentially reducing story shears and base shear, may require large clearances to allow pendulum motion of the supported components and may produce excessive demands on attached piping. Dynamic analysis should be performed in such cases, with consideration for appropriate impact forces in the absence of adequate clearances.

3. Relative rigidity of beams: Even where a classic building model may seem appropriate, the equivalent lateral force procedure may underpredict the total response if the beams are flexible relative to the columns (of moment frames) or the braces (of braced frames). This is because higher modes associated with beam flexure may contribute more significantly to the total response (even if the first mode response is at a period less than $3.5T_s$). This situation of flexible beams can be especially pronounced for nonbuilding structures since the “normal” floors common to buildings may be absent. Therefore, the dynamic analysis procedures are recommended for building-like nonbuilding structures with flexible beams.

Nonbuilding Structures Not Similar to Buildings. The (static) equivalent lateral force procedure is based on classic building dynamic behavior, which is an inappropriate characterization for many nonbuilding structures not similar to buildings. As discussed below, several issues should be considered for selecting either an appropriate method of dynamic analysis or a suitable distribution of lateral forces for static analysis.

1. Structural geometry: The dynamic response of nonbuilding structures with a fixed base and a relatively uniform distribution of mass and stiffness, such as bottom-supported vertical vessels, stacks, and chimneys, can be represented adequately by a cantilever (shear building) model. For these structures the equivalent lateral force procedure provided in the standard is suitable. This procedure treats the dynamic response as being dominated by the first mode. In such cases, it is necessary to identify the first mode shape (using, for instance, the Rayleigh-Ritz method or other classical methods from the literature) for distribution of the dynamic forces. For some structures, such as tanks with low height-to-diameter ratios storing granular solids, it is conservative to assume a uniform distribution of forces. Dynamic analysis is recommended for structures that have neither a uniform distribution of mass and stiffness nor an easily determined first mode shape.
2. Number of lateral supports: Cantilever models are obviously unsuitable for structures with multiple supports. Figure C15.1-4 shows a nonbuilding braced frame structure that provides non-uniform horizontal support to a piece of equipment. In such cases, the analysis should include coupled model effects. For such structures an application of the equivalent lateral force method could be used depending on the number and locations of the supports. For example, most beam-type configurations lend themselves to application of the equivalent lateral force method.

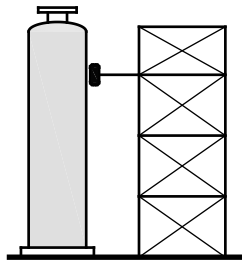

Figure C15.1-4 Multiple lateral supports.

3. Method of supporting dead weight: Certain nonbuilding structures (such as power boilers) are supported from the top. They may be idealized as pendulums with uniform mass distribution. In contrast, a suspended platform may be idealized as a classic pendulum with concentrated mass. In either case, these types of nonbuilding structures can be analyzed adequately using the equivalent lateral force method by calculating the appropriate frequency and mode shape. Figure C15.1-5 shows a nonbuilding structure containing lug supported equipment with W_p greater than $0.25(W_s + W_p)$. In such cases, the analysis should include a coupled system with the mass of the equipment and the local flexibility of the supports considered in the model. Where the support is located near the nonbuilding structure’s vertical location of the center of mass, a dynamic analysis is recommended.

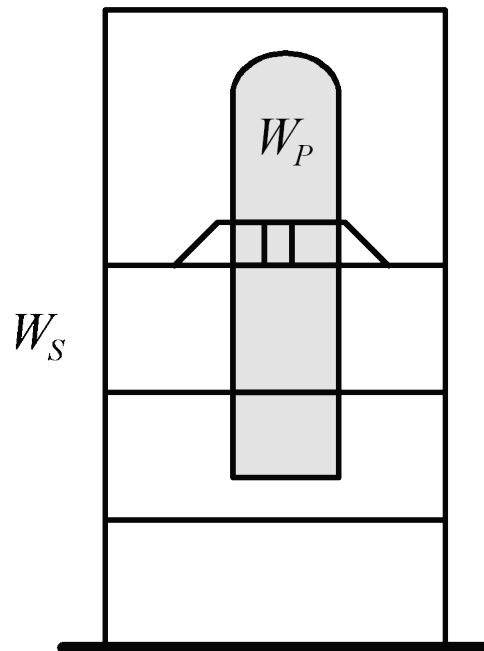

Figure C15.1-5 Unusual support of dead weight.

4. Mass irregularities: Just as in the case of building-like nonbuilding structures, the presence of significantly uneven mass distribution can render the structures unsuitable for application of the equivalent lateral force method. The dynamic analysis methods are recommended in such situations. Figure C15.1-6 illustrates two such situations. In part (a), a mass irregularity exists if W_1 is greater than $1.5W_2$ or less than $0.67W_2$. In part (b), a mass irregularity exists if W_3 is greater than either $1.5W_2$ or $1.5W_4$.

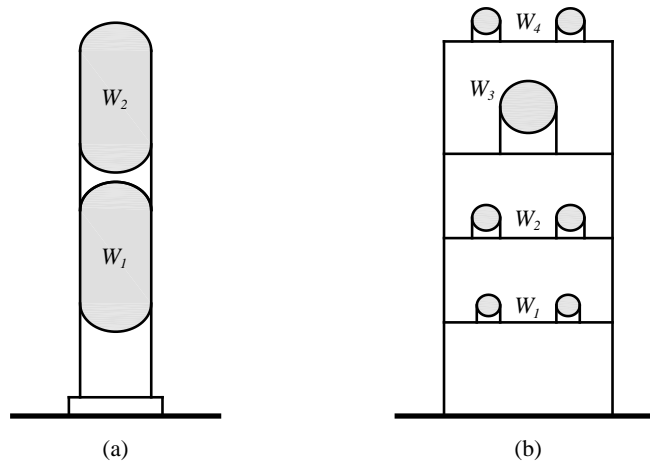

Figure C15.1-6 Mass irregularities.

5. Torsional irregularities: Structures in which the fundamental mode of response is torsional or in which modes with significant mass participation exhibit a prominent torsional component may also have inertial force distributions that are significantly different from that predicted by the equivalent lateral force method. In such cases dynamic analyses should be considered. Figure C15.1-7 illustrates one such case where a vertical vessel is attached to a secondary vessel with W_2 greater than about $0.25(W_1 + W_2)$.

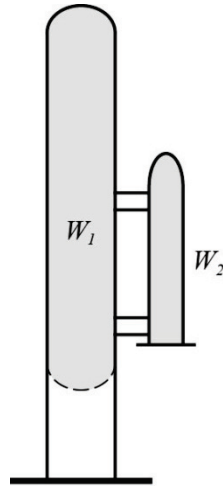

Figure C15.1-7 Torsional irregularity.

6. Stiffness/strength irregularities: Just as for building-like nonbuilding structures, abrupt changes in the distribution of stiffness or strength in a nonbuilding structure not similar to buildings can result in substantially different inertial forces that differ substantially from those indicated by the equivalent lateral force method. Figure C15.1-8 represents one such case. For structures having such configurations, consideration should be given to use of dynamic analysis procedures. Even where dynamic analysis is required, the standard does not define in any detail the degree of modeling; an adequate model may have a few dynamic degrees of freedom or tens of thousands of dynamic degrees of freedom. The important point is that the model captures the significant dynamic response features so that the resulting lateral force distribution is valid for design. The designer is responsible to determine whether dynamic analysis is warranted and, if so, the degree of detail required to address adequately the seismic performance.

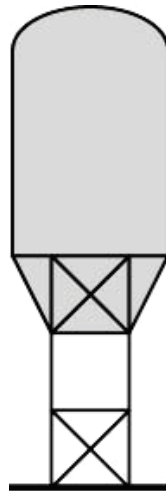

Figure C15.1-8 Soft-story irregularity.

7. **Coupled Response:** Where the weight of the supported structure is large compared to the weight of the supporting structure, the combined response can be affected significantly by the flexibility of the supported nonbuilding structure. In that case, dynamic analysis of the coupled system is recommended. Examples of such structures are shown in Figure C15.1-9. Part (a) shows a flexible nonbuilding structure with W_p greater than $0.25(W_s + W_p)$, supported by a relatively flexible structure; the flexibility of the supports and attachments should be considered. Part (b) shows flexible equipment connected by a large-diameter, thick-walled pipe and supported by a flexible structure; the structures should be modeled as a coupled system including the pipe.

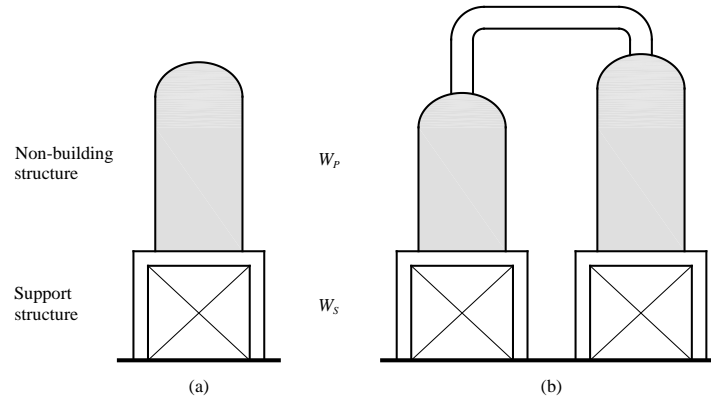

Figure C15.1-9 Coupled system.

C15.2 REFERENCE DOCUMENTS

Chapter 15 of the standard makes extensive use of reference documents in the design of nonbuilding structures for seismic forces. The documents referenced in Chapter 15 are industry documents commonly used to design specific types of nonbuilding structures. The vast majority of these reference documents contain seismic provisions that are based on the seismic ground motions of the 1997 UBC or earlier editions of the UBC. In order to use these reference documents, Chapter 15 modifies the seismic force provisions of these reference documents through the use of “bridging equations.” The standard only modifies industry documents that specify seismic demand and capacity. The bridging equations are intended to be used directly with the other provisions of the specific reference documents. Unlike the other provisions of the standard, if the reference documents are written terms of allowable stress design, then the bridging equations are shown in allowable stress design format. In addition, the detailing requirements referenced in Tables 15.4-1 and Table 15.4-2 must be followed, as well as the general requirements found in Section 15.4.1. The usage of reference documents in conjunction with the requirements of Section 15.4.1 are summarized below in Table C15.2-1.

Table C15.2-1 Usage of Reference Documents in Conjunction with Section 15.4.1

Subject	Requirement
R , Ω_0 , and C_d values, detailing requirements, and height limits	Use values and limits in Tables 12.2-1, 15.4-1, or 15.4-2 as appropriate. Values from the reference document are not to be used.
Minimum base shear	Use the appropriate value from Equation 15.4-1 or 15.4-2 for nonbuilding structures not similar to buildings. For structures containing liquids, gases, and granular solids supported at the base, the minimum seismic force cannot be less than that required by the reference document.
Importance factor	Use the value from Section 15.4.1.1 based on Occupancy Category. Importance factors from the reference document are not to be used unless they are greater than those provided in the standard.
Vertical distribution of lateral load	Use requirements of Section 12.8.3 or Section 12.9 or the applicable reference document.
Seismic provisions of reference documents	The seismic force provisions of reference documents may be used only if they have the same basis as Section 11.4 and the resulting values for total lateral force and total overturning moment are no less than 80 percent of the values obtained from the standard.
Load combinations	Load combinations specified in Section 2.3 (LRFD) or Section 15 (includes ASD load combinations of Section 2.4) must be used.

Currently, only two reference documents have been revised to meet the seismic requirements of the standard. AWWA D100-05 and API 650 10th Edition Addendum 4 (2005) have been adopted by reference in the standard without modification except that height limits are imposed on “elevated tanks on symmetrically braced legs (not similar to buildings)” in AWWA D100-05. Both of these reference documents apply to welded steel liquid storage tanks.

C15.3 NONBUILDING STRUCTURES SUPPORTED BY OTHER STRUCTURES

There are instances where nonbuilding structures not similar to buildings are supported by other structures or other nonbuilding structures. This section specifies how the seismic design loads for such structures are to be determined and the detailing requirements that are to be satisfied in the design.

C15.3.1 Less than 25 Percent of Combined Weight Condition. In many instances, the weight of the supported nonbuilding structure is relatively small compared to the weight of the supporting structure such that the supported nonbuilding structure will have a relatively small effect on the overall nonlinear earthquake response of the primary structure during design-level ground motions. It is permitted to treat such structures as nonstructural components and use the requirements of Chapter 13 for their design. The ratio of secondary component weight to total weight of 25 percent at which this treatment is permitted is based on judgment and was introduced into code provisions in the 1988 *Uniform Building Code* by the SEAOC Seismology Committee. Analytical studies, typically based on linear elastic primary and secondary structures, indicate that the ratio should be lower, but the SEAOC Seismology Committee judged that the 25 percent ratio is appropriate where primary and secondary structures exhibit non-linear behavior that tends to lessen the effects of resonance and interaction. In cases where a nonbuilding structure (or nonstructural component) is supported by another structure, it may be appropriate to analyze in a single model. In such cases it is intended that seismic design loads and detailing requirements be determined following the procedures of Section 15.3.2. Where there are multiple large nonbuilding structures, such as vessels supported on a primary nonbuilding structure, and the weight of an individual supported nonbuilding structure does not exceed the 25 percent limit but the combined weight of the supported nonbuilding structures does, it is recommended that the combined analysis and design approach of Section 15.3.2 be used. It is also suggested that dynamic analysis be performed in such cases, since the equivalent lateral force procedure may not capture some important response effects in some members of the supporting structure.

Where the weight of the supported nonbuilding structure does not exceed the 25 percent limit and a combined analysis is performed, the following procedure should be used to determine the F_p force of the supported nonbuilding structure based on Equation 13.3-4:

1. A modal analysis should be performed in accordance with Section 12.9. The base shear of the combined structure and nonbuilding structure should be taken as no less than 85 percent of the equivalent lateral force procedure base shear.
2. For a component supported at level i , the acceleration at that level should be taken as a_i , the total shear just below level i divided by the seismic weight at and above level i .
3. The elastic value of the component shear force coefficient should next be determined as the shear force from the modal analysis at the point of attachment of the component to the structure divided by the weight of the component. This value is preliminarily taken as $a_i a_p$. Since a_p cannot be taken as less than 1.0, the value of a_p is taken as $a_i a_p / a_i$, except that the final value a_p need not be taken as greater than 2.5 and should not be taken as less than 1.0. The final value of $a_i a_p$ should be the final value of a_i determined in Step 2 multiplied by the final value of a_p determined earlier in this step.
4. The resulting value of $(a_i a_p)$ should be used in Equation 13.3-4; the resulting value of F_p is subject to the maximum and minimum values of Equations 13.3-2 and 13.3-3, respectively.

C15.3.2 Greater Than or Equal to 25 Percent Combined Weight Condition. Where the weight of the supported structure is relatively large compared to the weight of the supporting structure, the overall response can be affected significantly. The standard sets forth two analysis approaches, depending on the rigidity of the nonbuilding structure. The determination of what is deemed rigid or flexible is based on the same criteria used for nonstructural components.

Where the supported nonbuilding structure is rigid, it is acceptable to treat the supporting structure as a nonbuilding structure similar to a building and to determine its design loads and detailing using the requirements of Section 15.5. The design of the rigid nonbuilding structure and its anchorage is determined using the requirements of Chapter 13 with the amplification factor, a_p , taken as 1.0. However, this is a relatively rare condition since the flexibility of any directly supporting members in the primary structure, such as floor beams, must be considered in determining the period of the component.

In the usual case, where the supported nonbuilding structure is flexible, a combined model of the supporting structure and the supported nonbuilding structure is used. The design loads and detailing are determined based on the lower R value of the supported nonbuilding structure or supporting structure.

Although not specifically mentioned in Section 15.3.2, another approach is permitted. A nonlinear response history analysis of the combined system can be performed in accordance with Section 16.2, and the results can be used for the design of both the supported and supporting nonbuilding structures. This option should be considered where standard static and dynamic elastic analysis approaches may be inadequate to evaluate the earthquake response (such as for suspended boilers). This option should be used with extreme caution since modeling and interpretation of results requires considerable judgment. Due to this sensitivity, Section 16.2 requires independent design review.

C15.4 STRUCTURAL DESIGN REQUIREMENTS

This section specifies the basic coefficients and minimum design forces to be used to determine seismic design loads for nonbuilding structures. It also specifies height limits and restrictions. As with building structures, it presumes that the first step in establishing the design forces is to determine the design base shear for the structure.

There are two types of nonbuilding structures: those with structural systems similar to buildings and those with structural systems not similar to buildings. Specific requirements for these two cases appear in Sections 15.5 and 15.6.

C15.4.1 Design Basis. Separate tables are provided in this section that identify the basic coefficients, associated detailing requirements, and height limits and restrictions for the two types of nonbuilding structures.

For nonbuilding structures similar to buildings, the design seismic loads are determined using the same procedures used for buildings as specified in Chapter 12 with two exceptions: fundamental periods are determined in accordance with Section 15.4.4, and Table 15.4-1 provides additional options for structural systems. Although only Section 12.8 (the equivalent lateral force procedure) is specifically mentioned in Section 15.4.1, Section 15.1.3 provides the analysis procedures that are permitted for nonbuilding structures.

In Table 15.4-1, seismic coefficients, system restrictions, and height limits are specified for a few nonbuilding structures similar to buildings. The values of R , Ω_o , and C_d , the detailing requirement references, and the structural system height limits are the same as those in Table 12.2-1 for the same systems, except for ordinary moment frames. In Chapter 12 increased height limits for ordinary moment frames structural systems apply to metal building systems, while in Chapter 15 they apply to pipe racks with end plate bolted moment connections. The seismic performance of pipe racks was judged to be similar to that of metal building structures with end plate bolted moment connections, so the height limits were made the same as those specified in previous editions.

Table 15.4-1 also provides lower R values with less restrictive height limits in Seismic Design Categories D, E, and F based on good performance in past earthquakes. For some options, no seismic detailing is required if very low values of R (and corresponding high seismic design forces) are used. The concept of extending this approach to other structural systems is the subject of future research using the methodology developed by the ATC 63 project.

For nonbuilding structures not similar to buildings, the seismic design loads are determined as in Chapter 12 with three exceptions: the fundamental periods are determined in accordance with Section 15.4.4, the minima are those specified in Section 15.4.1.2, and the seismic coefficients are those specified in Table 15.4-2.

Some entries in Table 15.4-2 may seem to be conflicting or confusing. For example, the first major entry is for elevated tanks, vessels, bins, or hoppers. A subset of this entry is for tanks on braced or unbraced legs. This subentry is intended for structures where the supporting columns are integral with the shell (such as an elevated water tank). Tension-only bracing is allowed for such a structure. Where the tank or vessel is supported by building-like frames, the frames are to be designed in accordance with all of the restrictions normally applied to building frames. The entry for tanks or vessels supported on structural towers similar to buildings assumes that the operating weight of the supported tank or vessel is less than 25 percent of the total weight; if the ratio is greater than 25 percent, the proper entry is that most closely related to the subject vessel or bin.

C15.4.1.1 Importance Factor. The importance factor for a nonbuilding structure is based on the occupancy category defined in Chapter 1 of the standard or the building code being used in conjunction with the standard. In some cases, reference standards provide a higher importance factor, in which case the higher importance factor is used.

If the importance factor is taken as 1.0 based on a Hazard and Operability (HAZOP) analysis performed in accordance with Chapter 1, the third paragraph of Section 1.5.2 requires careful consideration; worst-case scenarios (instantaneous release of a vessel or piping system) must be considered. HAZOP risk analysis consultants often do not make such assumptions, so the design professional should review the HAZOP analysis with the HAZOP consultant to confirm that such assumptions have been made in order to validate adjustment of the importance factor. Clients may not be aware that HAZOP consultants do

not normally consider the worst-case scenario of instantaneous release but tend to focus on other more hypothetical limited-release scenarios, such as those associated with a 2-inch square hole in a tank or vessel.

C15.4.2 Rigid Nonbuilding Structures. The definition of rigid (having a natural period of less than 0.06 second) was selected judgmentally. Below that period, the energy content of seismic ground motion is generally believed to be very low, and therefore the building response is not likely to be excessively amplified. Also, it is unlikely that any building will have a first mode period as low as 0.06 second, and it is even unusual for a second mode period to be that low. Thus, the likelihood of either resonant behavior or excessive amplification becomes quite small for equipment having periods below 0.06 second.

The analysis to determine the period of the nonbuilding structure should include the flexibility of the soil subgrade.

C15.4.3 Loads. As for buildings, the seismic weight must include the range of design operating weight of permanent equipment.

C15.4.4 Fundamental Period. A significant difference between building structures and nonbuilding structures is that the approximate period formulas and limits of Section 12.8.2.1 may not be used for nonbuilding structures. In lieu of calculating a specific period for a nonbuilding structure for determining seismic lateral forces, it is of course conservative to assume a period of $T_s (= S_{D1}/S_{DS})$ which results in the largest lateral design forces. Computing the fundamental period is not considered a significant burden, since most commonly used computer analysis programs can perform the required calculations.

C15.4.8 Site-Specific Response Spectra. Where site-specific response spectra are required, they should be developed in accordance with Chapter 21 of the standard. If determined for other recurrence intervals, Section 21.1 applies, but Sections 21.2 through 21.4 apply only to MCE determinations. Where other recurrence intervals are used, it should be demonstrated that the requirements of Chapter 15 also are satisfied.

C15.5 NONBUILDING STRUCTURES SIMILAR TO BUILDINGS

C15.5.1 General. Although certain nonbuilding structures exhibit behavior similar to that of building structures, their functions and occupancies are different. Section 15.5 of the standard addresses the differences.

C15.5.2 Pipe Racks. Free-standing pipe racks supported at or below grade with framing systems that are similar to building systems are designed in accordance with Section 12.8 or 12.9 and Section 15.4. Single-column pipe racks that resist lateral loads should be designed as inverted pendulums.

Based on good performance in past earthquakes, Table 15.4-1 sets forth the option of lower *R* values and less restrictive height limits for structural systems commonly used in pipe racks. The *R* value versus height limit trade-off recognizes that the size of some nonbuilding structures is determined by factors other than traditional loadings and results in structures that are much stronger than required for seismic loadings. Therefore, the ductility demand is generally much lower than that for a corresponding building. The intent is to obtain the same structural performance at the increased heights. This option will prove to be economical in most situations due to the relative cost of materials and construction labor. The lower *R* values and increased height limits of Table 15.4-1 apply to nonbuilding structures similar to buildings; they cannot be applied to building structures. Table C15.5-1 illustrates the *R* values and height limits for a 70-foot-high steel ordinary moment frame (OMF) pipe rack.

Table C15.5-1 R Value Selection Example for Steel OMF Pipe Racks

SDC	R	ASCE/SEI 7-05 Table	System	Seismic Detailing Requirements
C	3.5	12.2-1 or 15.4-1	Ordinary steel moment frame	AISC 341
C	3	12.2-1	Structural steel systems not specifically detailed for seismic resistance	None
D or E	2.5	15.4-1	Steel OMF with permitted height increase	AISC 341 (AISC Seismic)
D, E, or F	1	15.4-1	Steel OMF with unlimited height	None

C15.5.3 Steel Storage Racks. The two approaches to the design of steel storage racks set forth by the standard are intended to produce comparable results.

These recommendations address the concern that storage racks in warehouse-type retail stores may pose a greater seismic risk to the general public than exists in low-occupancy warehouses or more conventional retail environments. Under normal conditions, retail stores have a far higher occupant load than an ordinary warehouse of a comparable size. Failure of a

storage rack system in a retail environment is much more likely to cause personal injury than a similar failure in a storage warehouse. To provide an appropriate level of additional safety in areas open to the public, an importance factor of 1.50 is specified. Storage rack contents, while beyond the scope of the standard, may pose a potentially serious threat to life should they fall from the shelves in an earthquake. It is recommended that restraints be provided, as shown in Figure C15.5-1, to prevent the contents of rack shelving open to the general public from falling during strong ground shaking.



Figure C15.5-1 Merchandise restrained by netting.

C15.5.4 Electrical Power Generating Facilities. Electrical power plants closely resemble building structures, and their performance in seismic events has been good. For reasons of mechanical performance, lateral drift of the structure must be limited. The lateral bracing system of choice has been the concentrically braced frame. In the past, the height limits on braced frames in particular have been an encumbrance to the design of large power generating facilities. Based on acceptable past performance, Table 15.4-1 permits the use of CBRs with both lower R values and less restrictive height limits. This option is particularly effective for boiler buildings that generally are 300 feet or more in height. A peculiarity of large boiler buildings is the general practice of suspending the boiler from the roof structures; this results in an unusual mass distribution as discussed in Section C15.1.3.

C15.5.5 Structural Towers for Tanks and Vessels. The requirements of this section apply to structural towers that are not integral with the supported tank. Elevated water tanks designed in accordance with AWWA D100-06 are not subject to Section 15.5.5.

C15.5.6 Piers and Wharves. Current industry practice recognizes the distinct differences between the two categories of piers and wharves described in the standard. Piers and wharves with public occupancy, described in Section 15.5.6.2, are commonly treated as the “foundation” for buildings or building-like structures; design is performed using the standard, likely under the jurisdiction of the local building official. Piers and wharves without occupancy by the general public are often treated differently and are outside the scope of the standard; in many cases, these structures do not fall under the jurisdiction of building officials, and design is performed using other industry-accepted approaches.

Design decisions associated with these structures often reflect economic considerations by both owners and local, regional, or state jurisdictional entities with interest in commercial development. Where building officials have jurisdiction but lack experience analyzing pier and wharf structures, reliance on other industry-accepted design approaches is common.

Where occupancy by the general public is not a consideration, seismic design of structures at major ports and marine terminals often uses a performance-based approach, with criteria and methods that are very different from those used for buildings, as provided in the standard. Design approaches most commonly used are generally consistent with the practices and criteria described in the following documents:

1. *Seismic Design Guidelines for Port Structures*, Working Group No. 34 of the Maritime Navigation Commission (PIANC/MarCom/WG34), A. A. Balkema, Lisse, Netherlands, 2001.
2. *Seismic Criteria for California Marine Oil Terminals*, Vol. 1 and Vol. 2, Technical Report TR-2103-SHR, Naval Facilities Engineering Service Center, Ferritto, J., Dickenson, S., Priestley N., Werner, S., Taylor, C., Burke D., Seelig

- W., and Kelly, S., Port Hueneme, CA, 1999.
3. *Seismic Design and Retrofit of Bridges*, Priestley, N.J.N., Siebel, F., and Calvi, G.M., New York, 1996.
 4. *Seismic Guidelines for Ports*, by the Ports Committee of the Technical Council on Lifeline Earthquake Engineering, ASCE/SEI, edited by Stuart D. Werner, Monograph No. 12, published by ASCE, Reston, Virginia, March 1998.
 5. *MOTEMS, 2005, "Marine Oil Terminal Engineering and Maintenance Standards"*, 2001 Title 24, Part 2, California Building Code, Chapter 31F, January 31, 2005.

These alternative approaches have been developed over a period of many years by working groups within the industry, and they reflect the historical experience and performance characteristics of these structures, which are very different from those of building structures.

The main emphasis of the performance-based design approach is to provide criteria and methods that depend on the economic importance of a facility. Adherence to the performance criteria in the documents listed above does not seek to provide uniform margins of collapse for all structures; their application is expected to provide at least as much inherent life-safety as for buildings designed using the standard. The reasons for the higher inherent level of life-safety for these structures include the following:

1. These structures have relatively infrequent occupancy, with few working personnel and very low density of personnel. Most of these structures consist primarily of open area, with no enclosed structures that can collapse onto personnel. Small control buildings on marine oil terminals or similar secondary structures are commonly designed in accordance with the local building code.
2. These pier or wharf structures typically are constructed of reinforced concrete, prestressed concrete, or steel and are highly redundant due to the large number of piles supporting a single wharf deck unit. Tests done at the University of California at San Diego for the Port of Los Angeles have shown that very high ductilities (10 or more) can be achieved in the design of these structures using practices currently employed in California ports.
3. Container cranes, loading arms, and other major structures or equipment on piers or wharves are specifically designed not to collapse in an earthquake. Typically, additional piles and structural members are incorporated into the wharf or pier specifically to support such items.
4. Experience has shown that seismic "failure" of wharf structures in zones of strong seismicity is indicated not by collapse but by economically irreparable deformations of the piles. The wharf deck generally remains level or slightly tilting, but has shifted out of position. Complete failure that could endanger life-safety due to earthquake loading has never occurred historically where the structure in the marine environment has been maintained properly.
5. The performance-based criteria of the listed documents address reparability of the structure, which is much more stringent criteria than collapse prevention and results in a greater margin for life-safety.

Lateral load design of these structures in low, or even moderate, seismic regions often is governed by other marine conditions.

C15.6 GENERAL REQUIREMENTS FOR NONBUILDING STRUCTURES NOT SIMILAR TO BUILDINGS

Nonbuilding structures not similar to buildings exhibit behavior markedly different from that of building structures. Most of these types of structures have reference documents that address their unique structural performance and behavior. The ground motion in the standard requires appropriate translation to allow use with industry standards.

C15.6.1 Earth-Retaining Structures. Section C11.8.3 presents commonly used approaches for the design of nonyielding walls and yielding walls for bending, overturning, sliding, etc., taking into account the varying soil types, importance, and site seismicity.

C15.6.2 Stacks and Chimneys. The design of stacks and chimneys to resist natural hazards generally is governed by wind design considerations. The exceptions to this general rule involve locations with high seismicity, stacks and chimneys with large elevated masses, and stacks and chimneys with unusual geometries. It is prudent to evaluate the effect of seismic loads in all but those areas with the lowest seismicity. Although not specifically required, it is recommended that the special seismic details required elsewhere in the standard be considered for application to stacks and chimneys.

Guyed steel stacks and chimneys generally are lightweight. As a result, the design loads due to natural hazards generally are governed by wind. On occasion, large flares or other elevated masses located near the top may require in-depth seismic analysis. Although it does not specifically address seismic loading, Chapter 6 of Troitsky (1982) provides a methodology appropriate for resolution of the seismic forces defined in the standard.

C15.6.4 Special Hydraulic Structures. The most common special hydraulic structures are baffle walls and weirs that are used in water treatment and waste water treatment plants. Because there are openings in the walls, during normal operations the fluid levels are equal on each side of the wall, exerting no net horizontal force. Sloshing during a seismic event can exert large forces on the wall, as illustrated in Figure C15.6-1. The walls can fail unless they are designed properly to resist the dynamic fluid forces.

C15.6.5 Secondary Containment Systems. This section reflects the judgment that designing all impoundment dikes for the MCE ground motion when full and sizing all impoundment dikes for the sloshing wave is too conservative. Designing an impoundment dike as full for the MCE assumes failure of the primary containment and occurrence of a significant aftershock. Such significant aftershocks (of the same magnitude as the MCE ground motion) are rare and do not occur in all locations. While explicit design for aftershocks is not a requirement of the standard, secondary containment must be designed full for an aftershock to protect the general public. The use of two-thirds of the MCE ground motion as the magnitude of the design aftershock is supported by Bath's Law, according to which the maximum expected aftershock magnitude may be estimated to be 1.2 scale units below the main shock magnitude.

The risk assessment and risk management plan described in Section 1.5.2 are used to determine where the secondary containment must be designed full for the MCE. The decision to design secondary containment for this more severe condition should be based on the likelihood of a significant aftershock occurring at the particular site, considering the risk posed to the general public by the release of hazardous material from the secondary containment.

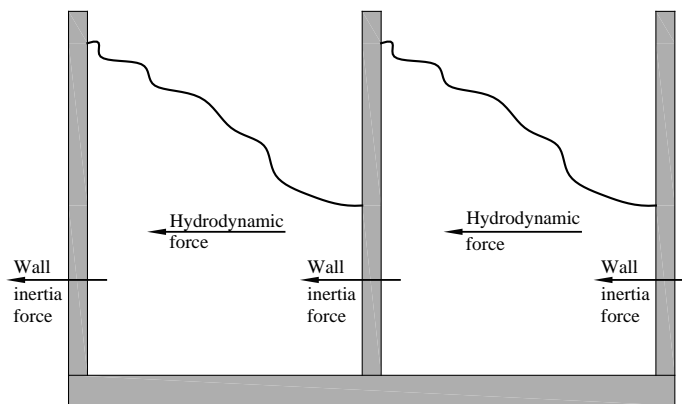

Figure C15.6-1 Wall forces.

Secondary containment systems must be designed to contain the sloshing wave where the release of liquid would place the general public at risk by exposing them to hazardous materials, by scouring of foundations of adjacent structures, or by causing other damage to adjacent structures.

C15.6.6 Telecommunication Towers. Telecommunication towers support small masses, and their design generally is governed by wind forces. Although telecommunication towers have a history of experiencing seismic events without failure or significant damage, seismic design in accordance with the standard is required.

Typically bracing elements bolt directly (without gusset plates) to the tower legs, which consist of pipes or bent plates in a triangular plan configuration.

C15.7 TANKS AND VESSELS

C15.7.1 General. Methods for seismic design of tanks, currently adopted by a number of reference documents, have evolved from earlier analytical work by Jacobsen, Housner, Veletsos, Haroun, and others. The procedures used to design flat-bottom storage tanks and liquid containers are based on the work of Housner, Wozniak, and Mitchell. The reference documents for tanks and vessels have specific requirements to safeguard against catastrophic failure of the primary structure based on observed behavior in seismic events since the 1930s. Other methods of analysis, using flexible shell models, have been proposed but at present are beyond the scope of the standard.

The industry-accepted design methods employ three basic steps:

1. Dynamic modeling of the structure and its contents. When a liquid-filled tank is subjected to ground acceleration, the lower portion of the contained liquid, identified as the impulsive component of mass, W_i , acts as if it were a solid mass

rigidly attached to the tank wall. As this mass accelerates, it exerts a horizontal force, P_i , on the wall; this force is directly proportional to the maximum acceleration of the tank base. This force is superimposed on the inertia force of the accelerating wall itself, P_s . Under the influence of the same ground acceleration, the upper portion of the contained liquid responds as if it were a solid mass flexibly attached to the tank wall. This portion, which oscillates at its own natural frequency, is identified as the convective component, W_c , and exerts a horizontal force, P_c , on the wall. The convective component oscillations are characterized by sloshing whereby the liquid surface rises above the static level on one side of the tank and drops below that level on the other side.

2. Determination of the period of vibration, T_i , of the tank structure and the impulsive component; and determination of the natural period of oscillation (sloshing), T_c , of the convective component.
3. Selection of the design response spectrum. The response spectrum may be site-specific or it may be constructed on the basis of seismic coefficients given in national codes and standards. Once the design response spectrum is constructed, the spectral accelerations corresponding to T_i and T_c are obtained and are used to calculate the dynamic forces P_i , P_s , and P_c .

Detailed guidelines for the seismic design of circular tanks, incorporating these concepts to varying degrees, have been the province of at least four industry reference documents: AWWA D100 for welded steel tanks (since 1964); API 650 for petroleum storage tanks; AWWA D110 for prestressed, wire-wrapped tanks (since 1986); and AWWA D115 for prestressed concrete tanks stressed with tendons (since 1995). In addition, API 650 and API 620 contain provisions for petroleum, petrochemical, and cryogenic storage tanks. The detail and rigor of analysis prescribed in these documents have evolved from a semi-static approach in the early editions to a more rigorous approach at present, reflecting the need to include the dynamic properties of these structures.

The requirements in Section 15.7 are intended to link the latest procedures for determining design-level seismic loads with the allowable stress design procedures based on the methods in the standard. These requirements, which in many cases identify specific substitutions to be made in the design equations of the reference documents, will assist users of the standard in making consistent interpretations.

ACI has published ACI 350.3-01, “*Seismic Design of Liquid-Containing Concrete Structures.*” This document, which addresses all types of concrete tanks (prestressed and non-prestressed, circular and rectilinear), has provisions that are consistent with the seismic criteria of the 2000 *Provisions*. The document serves as both a practical “ho-to” loading reference and a guide to supplement application of ACI 318 Chapter 21.

C15.7.2 Design Basis. In the case of the seismic design of nonbuilding structures, standardization requires adjustments to industry reference documents to minimize existing inconsistencies among them, while recognizing that structures designed and built over the years in accordance with these documents have performed well in earthquakes of varying severity. Of the inconsistencies among reference documents, the ones most important to seismic design relate to the base shear equation. The traditional base shear takes the following form:

$$V = \frac{ZIS}{R_w} CW \quad (\text{C15.7-1})$$

An examination of those terms as used in the different references reveals the following:

1. ZS : The seismic zone coefficient, Z , has been rather consistent among all the documents since it usually has been obtained from the seismic zone designations and maps in the model building codes. On the other hand, the soil profile coefficient, S , does vary from one document to another. In some documents these two terms are combined.
2. I : The importance factor, I , has varied from one document to another, but this variation is unavoidable and understandable owing to the multitude of uses and degrees of importance of tanks and vessels.
3. C : The coefficient C represents the dynamic amplification factor that defines the shape of the design response spectrum for any given ground acceleration. Since C is primarily a function of the frequency of vibration, inconsistencies in its derivation from one document to another stem from at least two sources: differences in the equations for the determination of the natural frequency of vibration, and differences in the equation for the coefficient itself. (For example, for the shell/impulsive liquid component of lateral force, the steel tank documents use a constant design spectral acceleration [constant C] that is independent of the “impulsive” period, T .) In addition, the value of C will vary depending on the damping ratio assumed for the vibrating structure (usually between 2 percent and 7 percent of critical).
4. Where a site-specific response spectrum is available, calculation of the coefficient C is not necessary except in the case of the convective component (coefficient C_c) which is assumed to oscillate with 0.5 percent of critical damping and whose period of oscillation is usually long (greater than 2.5 seconds). Since site-specific spectra are usually constructed for high damping values (3 percent to 7 percent of critical) and since the site-specific spectral profile may not be well-

defined in the long-period range, an equation for C_c applicable to a 0.5 percent damping ratio is necessary in order to calculate the convective component of the seismic force.

5. R_w : The response modification factor, R_w , is perhaps the most difficult to quantify, for a number of reasons. While R_w is a compound coefficient that is supposed to reflect the ductility, energy-dissipating capacity, and redundancy of the structure, it is also influenced by serviceability considerations, particularly in the case of liquid-containing structures.

In the standard the base shear equation for most structures has been reduced to $V = C_s W$, where the seismic response coefficient, C_s , replaces the product ZSC/R_w . C_s is determined from the design spectral response acceleration parameters S_{DS} and S_{DI} (at short periods and at a period of 1, respectively) which, in turn, are obtained from the mapped MCE spectral accelerations S_s and S_1 . As in the case of the prevailing industry reference documents, where a site-specific response spectrum is available, C_s is replaced by the actual values of that spectrum.

The standard contains several bridging equations, each designed to allow proper application of the design criteria of a particular reference document in the context of the standard. These bridging equations associated with particular types of liquid-containing structures and the corresponding reference documents are discussed below. Calculation of the periods of vibration of the impulsive and convective components is in accordance with the reference documents, and the detailed resistance and allowable stresses for structural elements of each industry structure are unchanged, except where new information has led to additional requirements.

It is expected that the bridging equations of Sections 15.7.7.3 and 15.7.10.7 will be eliminated as the relevant reference documents are updated to conform to the standard. The bridging equations previously provided for AWWA D100 and API 650 already have been eliminated as a result of updates of these documents.

C15.7.3 Strength and Ductility. As is the case for building structures, ductility and redundancy in the lateral support systems for tanks and vessels are desirable and necessary for good seismic performance. Tanks and vessels are not highly redundant structural systems, and therefore ductile materials and well-designed connection details are needed to increase the capacity of the vessel to absorb more energy without failure. The critical performance of many tanks and vessels is governed by shell stability requirements rather than by yielding of the structural elements. For example, contrary to building structures, ductile stretching of anchor bolts is a desirable energy absorption component where tanks and vessels are anchored. The performance of cross-braced towers is highly dependent on the ability of the horizontal compression struts and connection details to develop fully the tension yielding in the rods. In such cases, it is also important to preclude both premature failure in the threaded portion of the connection and failure of the connection of the rod to the column prior to yielding of the rod.

C15.7.4 Flexibility of Piping Attachments. Poor performance of piping connections (tank leakage and damage) due to seismic deformations is a primary weakness observed in recent seismic events. While commonly used piping connections can impart mechanical loads to the tank shell, proper design in seismic areas results in only negligible mechanical loads on tank connections subject to the displacements shown in Table 15.7-1. API 650 treats the values shown in Table 15.7-1 as allowable stress based values and therefore requires that these values be multiplied by 1.4 where strength-based capacity values are required for design.

In addition, interconnected equipment, walkways, and bridging between multiple tanks must be designed to resist the loads and accommodate the displacements imposed by seismic forces. Unless connected tanks and vessels are founded on a common rigid foundation, the calculated differential movements must be assumed to be out of phase.

C15.7.5 Anchorage. Many steel tanks can be designed without anchors by using annular plate detailing in accordance with reference documents. Where tanks must be anchored due to overturning potential, proper anchorage design will provide both a shell attachment and an embedment detail that will yield the bolt without tearing the shell or pulling the bolt out of the foundation. Properly designed anchored tanks have greater reserve strength to resist seismic overload than do unanchored tanks.

Where anchor bolts and attachments are misaligned such that the anchor nut or washer does not bear evenly on the attachment, additional bending stresses in threaded areas may cause premature failure before anchor yielding.

C15.7.6 Ground-Supported Storage Tanks for Liquids

C15.7.6.1 General. The response of ground storage tanks to earthquakes is well documented by Housner, Mitchell and Wozniak, Veletsos, and others. Unlike building structures, the structural response of these tanks is influenced strongly by the fluid-structure interaction. Fluid-structure interaction forces are categorized as sloshing (convective) and rigid (impulsive) forces. The proportion of these forces depends on the geometry (height-to-diameter ratio) of the tank. API 650, API 620, AWWA D100, AWWA D110, AWWA D115, and ACI 350.3 provide the data necessary to determine the relative masses and moments for each of these contributions.

The standard requires that these structures be designed in accordance with the prevailing reference documents, except that the height of the sloshing wave, δ_s , must be calculated using Equations 15.7-13. Note that API 650 and AWWA D100 include this requirement in their latest editions.

Equations 15.7-10 and 15.7-11 provide the spectral acceleration of the sloshing liquid for the constant-velocity and constant-displacement regions of the response spectrum, respectively. The 1.5 factor in these equations is an adjustment for 0.5 percent damping.

Small-diameter tanks and vessels are more susceptible to overturning and vertical buckling. As a general rule, a greater ratio of H/D produces lower resistance to vertical buckling. Where H/D is greater than 2, overturning approaches “rigid mass” behavior (the sloshing mass is small). Large-diameter tanks may be governed by additional hydrodynamic hoop stresses in the middle regions of the shell.

The impulsive period (the natural period of the tank components and the impulsive component of the liquid) is typically in the 0.25 to 0.6 second range. Many methods are available for calculating the impulsive period. The Veletsos flexible-shell method is commonly used by many tank designers. For example, see Veletsos (1974) and Malhotra, Wenk, and Wieland (2000).

C15.7.6.1.1 Distribution of Hydrodynamic and Inertia Forces. Most of the reference documents for tanks define reaction loads at the base of shell-foundation interface, without indicating the distribution of loads on the shell as a function of height. ACI 350.3 specifies the vertical and horizontal distribution of such loads.

The overturning moment at the base of the shell in the industry reference documents is only the portion of the moment that is transferred to the shell. The total overturning moment also includes the variation in bottom pressure, which is an important consideration for design of pile caps, slabs, or other support elements that must resist the total overturning moment. Wozniak and Mitchell (1978) and TID 7024 (1963) provide additional information.

C15.7.6.1.2 Sloshing. In past earthquakes, sloshing contents in ground storage tanks has caused both leakage and non-catastrophic damage to the roof and internal components. Even this limited damage, and the associated costs and inconvenience, can be significantly mitigated where the following items are considered:

1. Effective masses and hydrodynamic forces in the container.
2. Impulsive and pressure loads at
 - a. The sloshing zone (that is, the upper shell and edge of the roof system),
 - b. The internal supports (such as roof support columns and tray-supports), and
 - c. The internal equipment (such as distribution rings, access tubes, pump wells, and risers).
3. Freeboard (which depends on the sloshing wave height).

A minimum freeboard of $0.7\delta_s$ is recommended for economic considerations but is not required.

Tanks and vessels storing biologically or environmentally benign materials typically do not require freeboard to protect the public health and safety. However, providing freeboard in areas of frequent seismic occurrence for vessels normally operated at or near top capacity may lessen damage (and the cost of subsequent repairs) to the roof and upper container.

The sloshing wave height specified in Section 15.7.6.1.2 is based on the design earthquake defined in the standard. For economic reasons, freeboard for tanks assigned to Occupancy Category I, II, or III may be calculated using a fixed value of T_L equal to 4 seconds (as indicated in Section 15.7.6.1, Note d) but using the appropriate importance factor taken from Table 11.5-1. Due to life-safety concerns, freeboard for tanks assigned to Occupancy Category IV must be based on the mapped value of T_L . Because use of the mapped value of T_L results in the theoretical maximum value of freeboard, the calculation of freeboard in the case of Occupancy Category IV tanks is based on an importance factor equal to 1.0 (as indicated in Section 15.7.6.1, Note c).

If the freeboard provided is less than the computed sloshing height, δ_s , the sloshing liquid will impinge on the roof in the vicinity of the roof-to-wall joint, subjecting it to a hydrodynamic force. This force may be approximated by considering the sloshing wave as a hypothetical static liquid column having a height, δ_s . The pressure exerted at any point along the roof at a distance y_s above the at-rest surface of the stored liquid may be assumed equal to the hydrostatic pressure exerted by the hypothetical liquid column at a distance $\delta_s - y_s$ from the top of that column. A better approximation of the pressure exerted on the roof is found in Malhotra (2005 and 2006).

Another effect of a less-than-full freeboard is that the restricted convective (sloshing) mass “converts” into an impulsive mass thus increasing the impulsive forces. This effect should be taken into account in the tank design. A method for converting the

restricted convective mass into an impulsive mass is found in Malhotra (2005 and 2006). It is recommended that sufficient freeboard to accommodate the full sloshing height be provided wherever possible.

C15.7.6.1.4 Internal Components. Wozniak and Mitchell (1978) provides a recognized analysis method for determining the lateral loads on internal components due to sloshing liquid.

C15.7.6.1.5 Sliding Resistance. Historically, steel ground-supported tanks full of product have not slid off foundations. A few unanchored, empty tanks or bulk storage tanks without steel bottoms have moved laterally during earthquake ground shaking. In most cases, these tanks may be returned to their proper locations. Resistance to sliding is obtained from the frictional resistance between the steel bottom and the sand cushion on which bottoms are placed. Because tank bottoms usually are crowned upward toward the tank center and are constructed of overlapping, fillet-welded, individual steel plates (resulting in a rough bottom), it is reasonably conservative to take the ultimate coefficient of friction as 0.70 (AISC, 1986), and therefore a value of $\tan 30^\circ (= 0.577)$ is used in design. The value of 30° represents the internal angle of friction of sand. The vertical weight of the tank and contents, as reduced by the component of vertical acceleration, provides the net vertical load. An orthogonal combination of vertical and horizontal seismic forces, following the procedure in Section 12.5.3, may be used.

C15.7.6.1.6 Local Shear Transfer. The transfer of seismic shear from the roof to the shell and from the shell to the base is accomplished by a combination of membrane shear and radial shear in the wall of the tank. For steel tanks, the radial (out-of-plane) seismic shear is very small and usually is neglected; thus, the shear is assumed to be resisted totally by membrane (in-plane) shear. For concrete walls and shells, which have a greater radial shear stiffness, the shear transfer may be shared. The ACI 350.3 commentary provides further discussion.

C15.7.6.1.7 Pressure Stability. Internal pressure may increase the critical buckling capacity of a shell. Provision to include pressure stability in determining the buckling resistance of the shell for overturning loads is included in AWWA D100. Recent testing on conical and cylindrical shells with internal pressure yielded a design methodology for resisting permanent loads in addition to temporary wind and seismic loads. See Miller, Meier, and Czaska (1997).

C15.7.6.1.8 Shell Support. Anchored steel tanks should be shimmed and grouted to provide proper support for the shell and to reduce impact on the anchor bolts under reversible loads. The high bearing pressures on the toe of the tank shell may cause inelastic deformations in compressible material (such as fiberboard), creating a gap between the anchor and the attachment. As the load reverses, the bolt is no longer snug and an impact of the attachment on the anchor can occur. Grout is a structural element and should be installed and inspected as an important part of the vertical- and lateral-force-resisting system.

C15.7.6.1.9 Repair, Alteration, or Reconstruction. During their service life, storage tanks are frequently repaired, modified, or relocated. Repairs often are related to corrosion, improper operation, or overload from wind or seismic events. Modifications are made for changes in service, updates to safety equipment for changing regulations, or installation of additional process piping connections. It is imperative these repairs and modifications be designed and implemented properly to maintain the structural integrity of the tank or vessel for seismic loads as well as the design operating loads.

The petroleum steel tank industry has developed specific guidelines in API 653 that are statutory requirements in some states. It is recommended that the provisions of API 653 also be applied to other liquid storage tanks (water, wastewater, chemical, etc.) as it relates to repairs, modifications, or relocation that affects the pressure boundary or lateral force-resisting system of the tank or vessel.

C15.7.7 Water Storage and Water Treatment Tanks and Vessels. The AWWA design requirements for ground-supported steel water storage structures use allowable stress design procedures that conform to the requirements of the standard.

C15.7.8 Petrochemical and Industrial Tanks and Vessels Storing Liquids

C15.7.8.1 Welded Steel. The American Petroleum Institute (API) uses an allowable stress design procedure that conforms to the requirements of the standard.

The most common damage to tanks observed during past earthquakes includes the following:

1. Buckling of the tank shell near the base due to excessive axial membrane forces. This buckling damage is usually evident as “elephant foot” buckles a short distance above the base or as diamond-shaped buckles in the lower ring. Buckling of the upper ring also has been observed.
2. Damage to the roof due to impingement on the underside of the roof of sloshing liquid with insufficient freeboard.
3. Failure of piping or other attachments that are overly restrained.
4. Foundation failures.

Other than the above damage, the seismic performance of floating roofs during earthquakes has generally been good, with damage usually confined to the rim seals, gage poles, and ladders. However, floating roofs have sunk in some earthquakes due to lack of adequate freeboard or the proper buoyancy and strength required by API 650. Similarly the performance of open tops with top wind girder stiffeners designed per API 650 has been generally good.

C15.7.8.2 Bolted Steel. Bolted steel tanks are often used for temporary functions. Where use is temporary, it may be acceptable to the jurisdictional authority to design bolted steel tanks for no seismic loads or for reduced seismic loads based on a reduced return period. For such reduced loads based on reduced exposure time, the owner should include a signed removal contract with the fixed removal date as part of the submittal to the authority having jurisdiction.

C15.7.9 Ground-Supported Storage Tanks for Granular Materials

C15.7.9.1 General. The response of a ground-supported storage tank storing granular materials to a seismic event is highly dependent on its height-to-diameter (H/D) ratio and the characteristics of the stored product. The effects of intergranular friction are described in more detail in C15.7.9.3.1 (increased lateral pressure), C15.7.9.3.2 (effective mass), and C15.7.9.3.3 (effective density).

Long-term increases in shell hoop tension due to temperature changes after the product has been compacted also must be included in the analysis of the shell; Anderson (1966) provides a suitable method.

C15.7.9.2 Lateral Force Determination. Seismic forces acting on ground-supported liquid storage tanks are divided between impulsive and convective (sloshing) components. However, in a ground-supported storage tank for granular materials, all seismic forces are of the impulsive type and relate to the period of the storage tank itself. Due to the relatively short period of a tank shell, the response is normally in the constant acceleration region of the response spectrum, which relates to S_{DS} . Therefore, the seismic base shear is calculated as follows:

$$V = \frac{S_{DS}}{\left(\frac{R}{I}\right)} W_{Effective} \quad (C15.7-2)$$

where V , S_{DS} , I , and R have been previously defined, and $W_{Effective}$ is the gross weight of the stored product multiplied by an effective mass factor and an effective density factor, as described in Sections C15.7.9.3.2 and C15.7.9.3.3, plus the dead weight of the tank. Unless substantiated by testing, it is recommended that the product of the effective mass factor and the effective density factor be taken as no less than 0.5 due to the limited test data and the highly variable properties of the stored product.

C15.7.9.3 Force Distribution to Shell and Foundation

C15.7.9.3.1 Increased Lateral Pressure. In a ground-supported tank storing granular materials, increased lateral pressures develop as a result of rigid body forces that are proportional to ground acceleration. Information concerning design for such pressure is scarce. Trahair et al. (1983) describes both a very simple, conservative method and a very difficult, analytical method using failure wedges based on the Mononobe-Okabe modifications of the classical Coulomb method.

C15.7.9.3.2 Effective Mass. For ground-supported tanks storing granular materials, much of the lateral seismic load can be transferred directly into the foundation, via intergranular shear, before it can reach the tank shell. The effective mass that loads the tank shell is highly dependent on the H/D ratio of the tank and the characteristics of the stored product. Quantitative information concerning this effect is scarce, but Trahair et al. (1983) describes a very simple, conservative method to determine the effective mass. That method presents reductions in effective mass, which may be significant, for H/D ratios less than 2. This effect is absent for elevated tanks.

C15.7.9.3.3 Effective Density. Granular material stored in tanks (both ground-supported and elevated) does not behave as a solid mass. Energy loss through intergranular movement and grain-to-grain friction in the stored material effectively reduces the mass subject to horizontal acceleration. This effect may be quantified by an effective density factor less than 1.0.

Based on Chandrasekaran and Jain (1968) and on shake-table tests reported in Chandrasekaran et al. (1968), ACI 313 recommends an effective density factor of not less than 0.8 for most granular materials. According to Chandrasekaran and Jain (1968), an effective density factor of 0.9 is more appropriate for materials with high moduli of elasticity, such as aggregates and metal ores.

C15.7.9.3.4 Lateral Sliding. Most ground-supported steel storage tanks for granular materials rest on a base ring and do not have a steel bottom. To resist seismic base shear, a partial bottom or annular plate is used in combination with anchor bolts or a curb angle. An annular plate can be used alone to resist the seismic base shear through friction between the plate and the foundation, in which case the friction limits of Section 15.7.6.1.5 apply. The curb angle detail serves to keep the base of the

shell round while allowing it to move and flex under seismic load. Various base details are shown in Figure 13 of Kaups and Lieb (1985).

C15.7.9.3.5 Combined Anchorage Systems. This section is intended to apply to combined anchorage systems that share loads based on their relative stiffnesses, and not to systems where sliding is resisted completely by one system (such as a steel annular plate) and overturning is resisted completely by another system (such as anchor bolts).

C15.7.10 Elevated Tanks and Vessels for Liquids and Granular Materials

C15.7.10.1 General. The three basic lateral load-resisting systems for elevated water tanks are defined by their support structure:

1. Multi-leg braced steel tanks (trussed towers, as shown in Figure C15.7-1),
2. Small-diameter single-pedestal steel tanks (cantilever columns, as shown in Figure C15.7-2), and
3. Large-diameter single-pedestal tanks of steel or concrete construction (load-bearing shear walls, as shown in Figure C15.7-3).

Unbraced multi-leg tanks are uncommon. These types of tanks differ in their behavior, redundancy, and resistance to overload. Multi-leg and small-diameter pedestal tanks have longer fundamental periods (typically greater than 2 seconds) than the shear wall type tanks (typically less than 2 seconds). The lateral load failure mechanisms usually are brace failure for multi-leg tanks, compression buckling for small-diameter steel tanks, compression or shear buckling for large-diameter steel tanks, and shear failure for large-diameter concrete tanks. Connection, welding, and reinforcement details require careful attention in order to mobilize the full strength of these structures. To provide a greater margin of safety, R factors used with elevated tanks typically are less than those for other comparable lateral load-resisting systems.

C15.7.10.4 Transfer of Lateral Forces into Support Tower. The vertical loads and shears transferred at the base of a tank or vessel supported by grillage or beams typically vary around the base due to the relative stiffness of the supports, settlements, and variations in construction. Such variations must be considered in the design for vertical and horizontal loads.

C15.7.10.5 Evaluation of Structures Sensitive to Buckling Failure. Nonbuilding structures with little structural redundancy for lateral loads may exhibit total failure when loaded only slightly beyond the design loads. Tanks and vessels supported on shell skirts or pedestals that are governed by buckling require evaluation for this critical condition.

The design spectral response acceleration, S_a , used in this evaluation includes site factors. The I/R coefficient is taken as 1.0 for this critical check. The structural capacity of the shell is taken as the critical buckling strength (that is, the factor of safety is 1.0). Vertical and orthogonal combinations need not be considered for this evaluation, since the probability of peak values occurring simultaneously is very low.

While the standard requires this evaluation only for structures assigned to Occupancy Category IV, it may be applied to any buckling-sensitive structure. Where such optional evaluations are performed, an R value of 2 or 3 can be used. In most cases, the design of the structure will be governed by this additional evaluation.

C15.7.10.7 Concrete Pedestal (Composite) Tanks. A composite elevated water-storage tank is comprised of a welded steel tank for watertight containment, a single pedestal concrete support structure, a foundation, and accessories. The lateral load-resisting system is a load-bearing concrete shear wall. Since the seismic provisions in ACI 371R-98 are based on an older edition of ASCE/SEI 7, appropriate bridging equations are provided in Section 15.7.10.7.

C15.7.11 Boilers and Pressure Vessels. The support system for boilers and pressure vessels must be designed for the seismic forces and displacements presented in the standard. Such design must include consideration of the support, the attachment of the support to the vessel (even if “integral”), and the body of the vessel itself, which is subject to local stresses imposed by the support connection.

C15.7.12 Liquid and Gas Spheres. The commentary in Section C15.7.11 also applies to liquid and gas spheres.

C15.7.13 Refrigerated Gas Liquid Storage Tanks and Vessels. Some refrigerated storage tanks and vessels, such as those storing LNG, are required to be designed for ground motions and performance goals in excess of those found in the standard, so such structures are outside the scope of the standard. All other welded steel refrigerated storage tanks and vessels must be designed in accordance with the requirements of the standard, the requirements of API 620, and the seismic requirements of API 650. Note that the seismic requirements of API 620 (10th Edition, Addendum 1) are not used as they are inconsistent with the requirements of the standard.

C15.7.14 Horizontal, Saddle Supported Vessels for Liquid or Vapor Storage. Past practice has been to assume that a horizontal, saddle supported vessel (including its contents) behaves as a rigid structure (with natural period, T , less than 0.06 seconds). For this situation, seismic forces would be determined using the requirements of Section 15.4.2. For large horizontal, saddle-supported vessels (length-to-diameter ratio of 6 or more), this assumption can be unconservative, so Section 15.7.14.3 requires that the natural period be determined assuming the vessel to be a simply supported beam.



Figure C15.7-1 Multi-leg braced steel tank.

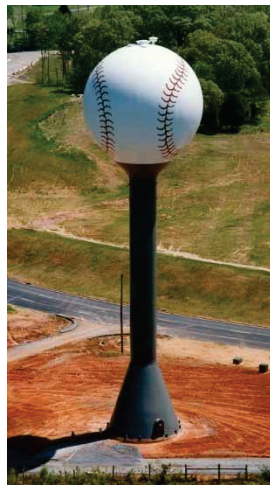
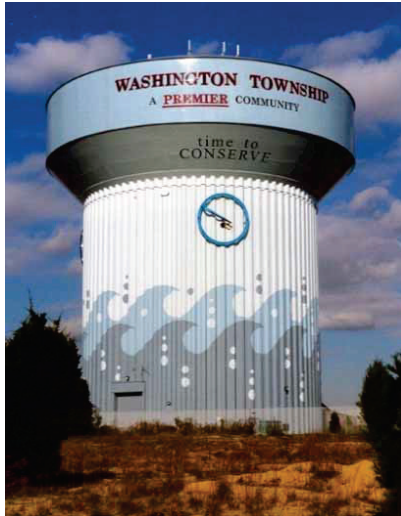

Figure C15.7-2 Small-diameter single-pedestal steel tank.



(a) Steel



(b) Concrete

Figure C15.7-3 Large-diameter single-pedestal tank.

REFERENCES

- American Institute of Steel Construction, Inc. 1986. *Load and Resistance Factor Design Specification for Structural Steel Buildings*.
- Anderson, P. F. 1966. "Temperature Stresses in Steel Grain-Storage Tanks," *ASCE Civil Engineering* (January):74.
- Chandrasekaran, A. R., and P. C. Jain. 1968. "Effective Live Load of Storage Materials Under Dynamic Conditions," *Indian Concrete Journal* (Bombay), 42(9):364-365.
- Chandrasekaran, A. R., S. S. Saini, and I. C. Jhamb. 1968. "Live Load Effects on Dynamic Behavior of Structures," *Journal of the Institution of Engineers* (India), 48:850-859.
- Kaups, Taavi, and John M. Lieb. 1985. *A Practical Guide for the Design of Quality Bulk Storage Bins and Silos*. Chicago Bridge & Iron Company, Plainfield, Illinois.
- Malhotra, P. K., T. Wenk, and M. Wieland. 2000. "Simple Procedure for Seismic Analysis of Liquid-Storage Tanks," *Journal of Structural Engineering International*, IABSE, 10(3):197-201.
- Malhotra, P. K. 2005. "Sloshing Loads in Liquid-Storage Tanks with Insufficient Freeboard," *Earthquake Spectra*, 21(4):1185-1192.
- Malhotra, P. K. 2006. "Earthquake Induced Sloshing in Cone and Dome Roof Tanks with Insufficient Freeboard." *Journal of Structural Engineering International*, IABSE, 16(3):222-225.
- Miller, C. D., S. W. Meier, and W. J. Czaska. 1997. "Effects of Internal Pressure on Axial Compressive Strength of Cylinders and Cones," paper presented at Structural Stability Research Council Annual Technical Meeting, June.
- Department of Energy. 1963. *Nuclear Reactors and Earthquakes*, TID 7024. Department of Energy, Atomic Energy Commission, Division of Reactor Development, Washington, D.C
- Trahair, M. S., A. Abel, P. Ansourian, H. M. Irvine, and J. M. Rotter. 1983. *Structural Design of Steel Bins for Bulk Solids*. Australian Institute of Steel Construction, Ltd., Sydney.
- Troitsky, M. S. 1982. *Tubular Steel Structures – Theory and Design*. The James F. Lincoln Arc Welding Foundation.
- Veletsos, A. S. 1974. "Seismic Effects in Flexible Liquid-Storage Tanks," in *Proceedings of the Fifth World Conference on Earthquake Engineering*, Rome, Italy, pp. 630-639.
- Wozniak, R. S., and W. W. Mitchell. 1978. "Basis of Seismic Design Provisions for Welded Steel Oil Storage Tanks," presented at the Session on Advances in Storage Tank Design, American Petroleum Institute, Refining, 43rd Midyear Meeting, Toronto, Canada, May 9.

Page intentionally left blank.

COMMENTARY TO CHAPTER 16, SEISMIC RESPONSE HISTORY PROCEDURES

C16.1 LINEAR RESPONSE HISTORY PROCEDURE

The standard does not require the use of linear response history analysis. However, the use of such analysis may be useful in validation of the results of the analysis methods presented in Chapter 12, or as a step in a series of analyses that culminate in a nonlinear response history analysis. While not commonly used in the past to design typical structures, this technique is seeing increased use in the design of some structures including structures that are neither damped nor base isolated.

The purpose of the linear response history procedure is to determine design forces for structural components and to compute displacements and story drifts, which must be within the limits specified by Table 12.12-1. In this sense, the linear response history procedure shares the force-based philosophy of the Equivalent Lateral Force (ELF) procedure and the Modal Response Spectrum (MRS) analysis procedure (both of which are specified in Chapter 12). Response history analysis offers several advantages over modal response spectrum analysis: it is more accurate mathematically, signs of response quantities (such as tension or compression in a brace) are not lost as a result of the combination of modal responses, and story drifts are computed more accurately. The principal disadvantages of response history analysis are the need to select and scale an appropriate suite of ground motions, and the necessity to perform analysis for several (usually seven) such motions. See Section C16.1.3 for discussion of ground motion selection and scaling techniques.

C16.1.1 Analysis Requirements. In response history analysis, the seismic hazard is characterized by a number of ground acceleration records. Using these records and a detailed mathematical model of the structure, nodal displacements and component forces are computed, step-by-step, by integration of the equations of motion. Two basic approaches for solving the equations may be used. In the first approach, called direct analysis, all the equilibrium equations for the entire system are solved simultaneously in each step. The number of equations solved equals the number of degrees of freedom in the structure.

In the second approach, called modal analysis, the equilibrium equations are transformed, by change of coordinates, into a number of single-degree-of-freedom (SDOF) systems. The maximum number of SDOF systems that can be formed is equal to the number of mass degrees of freedom in the structure. The SDOF equations are solved individually in time, and then the computed displacement histories are transformed back to the original coordinates and superimposed to obtain the system response history. The transformation of coordinates in the modal analysis approach is usually based on the undamped natural mode shapes of the structure. Other bases, such as a set of orthogonal load-dependent Ritz vectors, may be preferable in certain cases (Wilson et al., 1982).

Where modal analysis uses the full set of mode shapes and the damping ratios in each mode are identical to those obtained from the equations of motion used in the direct analysis, the two approaches produce identical results. A distinct advantage of the modal analysis approach is that a limited number of modes may be used to produce reasonably accurate results. While some accuracy is sacrificed where fewer modes are used, the computer resources required to perform the analysis are significantly less than those required for direct analysis. The number of modes required for a “reasonably” accurate analysis is discussed in Section C12.9.1.

C16.1.2 Modeling. The mathematical model used for linear response history analysis is usually identical to that used for modal response spectrum analysis, and it often reflects a preliminary design developed using the ELF procedure. The main modeling difference between response history analysis and modal response spectrum analysis is that the inherent damping (taken as 5 percent of critical) is included in the design response spectrum for response spectrum analysis, while it must be assigned explicitly for response history analysis.

In the modal analysis approach to response history analysis, damping is simply assigned to each mode that is included in the response (Wilson and Penzien, 1970). Although not specified in the standard, the damping used for each mode should be 5 percent of critical for consistency with the design response spectrum.

Direct response history analysis requires an explicit damping matrix. However, such a matrix cannot be formed from first principles; it is common to use a damping matrix that is proportional to the mass, the stiffness, or a linear combination of the two:

$$C = \alpha M + \beta K \quad (C16.1-1)$$

where C is the damping matrix, M is the mass matrix, K is the stiffness matrix, and α and β are scalar constants of proportionality. Such damping is often referred to as Rayleigh damping.

The proportionality constants are determined as follows:

$$\begin{Bmatrix} \alpha \\ \beta \end{Bmatrix} = 2 \begin{bmatrix} 1/\omega_a & \omega_a \\ 1/\omega_b & \omega_b \end{bmatrix}^{-1} \begin{Bmatrix} \xi_a \\ \xi_b \end{Bmatrix} \quad (C16.1-2)$$

where ξ_a and ξ_b are the desired damping ratios at any two system circular frequencies, ω_a and ω_b , where $\omega_b > \omega_a$. It is common, but not necessary, for the two specified frequencies to correspond to two of the system's lower natural frequencies (such as the first and third mode frequencies).

If both damping values are the same ($\xi = \xi_a = \xi_b$), which is usually the case, the mass and stiffness proportionality constants may be determined as follows:

$$\alpha = \xi \frac{2\omega_a\omega_b}{\omega_a + \omega_b}$$

$$\beta = \xi \frac{2}{\omega_a + \omega_b} \quad (C16.1-3)$$

The advantage of Rayleigh damping is that it is simple to implement because all the analyst has to do is to specify the two proportionality constants α and β , and these can be established using Equation C16.1-2 given the two desired damping ratios and corresponding frequencies. The disadvantage is that the damping ratios increase with frequency and may cause the higher mode contributions to response to be over-damped. This effect is shown in Figure C16.1-1, where the damping ratios ξ have been set at 0.05 at frequencies of 4.2 and 12.5 radians per second. The damping at all other frequencies is given by the curve marked "Total". For frequencies above approximately 32 radians per second, the damping is greater than 10 percent of critical and may be excessive.

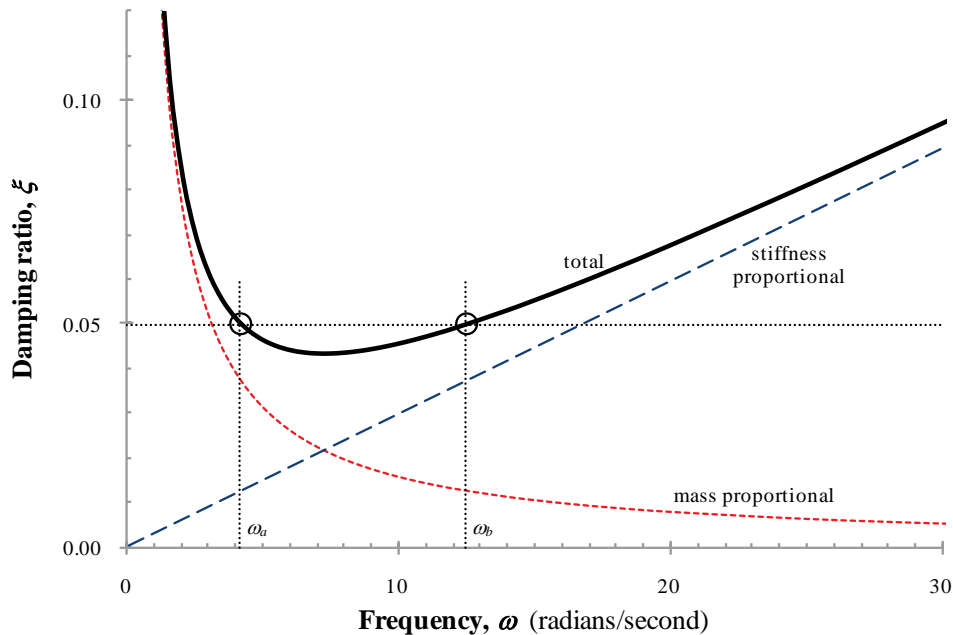

Figure C16.1-1 Example of Rayleigh damping.

C16.1.3 Ground Motion. One of the most demanding aspects of response history analysis is the selection and scaling of an appropriate suite of ground motions (Anderson and Bertero, 1987). It is considered appropriate to select records that have magnitudes, fault distances, source mechanisms, and soil conditions that are characteristic of the site. This poses quite a challenge even for sites in the western United States, where numerous records from large-magnitude earthquakes are available; it is virtually impossible in the central and eastern United States, where there are no recorded ground motions from large-magnitude events. (The web site for the Pacific Earthquake Engineering Research Center (PEER) provides a large number of ground motion acceleration records that may be used in response history analysis. In addition to the ground

motions, the PEER site provides detailed background information on the source characteristics of the ground motions and on the instrument and site characteristics of the particular station that recorded the acceleration record.)

Because of the scarcity of available recorded motions, use of simulated ground motions is permitted. To this end, available records may be modified for site distance and soil conditions. Such modification is considered part of the ground motion selection.

The standard requires that at least three ground motions (or ground motion pairs, in the case of three-dimensional analysis) be used, and it provides an incentive for using at least seven motions (as discussed in Section C16.1.4).

The scaling technique specified in Sections 16.1.3.1 and 16.1.3.2 is one of several that have been proposed. See Shome and Cornell (1998), Shome et al. (1998), Somerville et al. (1998), Mehraian and Naiem (2003), and Iervolino and Cornell (2005) for background on ground motion selection and scaling. (Applied Technology Council (ATC) Projects 58 and 63 are also investigating scaling techniques.)

C16.1.3.1 Two-Dimensional Analysis. This scaling method begins with ground motions that have been selected (and modified as necessary) to have magnitude, distance, and site conditions compatible with the maximum considered earthquake. The 5 percent damped pseudo-acceleration response spectra for these records are scaled for consistency with the design ground motion spectrum shown in Figure 11.4-1. For two-dimensional analysis, the ground motion spectra must be scaled such that the average of the spectra is not less than the design spectrum in the period range from $0.2T$ to $1.5T$, where T is the fundamental period of vibration of the structure being designed. The short period of the range ($0.2T$) is set to capture higher mode response, and the long period of the range ($1.5T$) is set to allow for period lengthening that would be associated with inelastic response.

C16.1.3.2 Three-Dimensional Analysis. Approaches to scaling ground motions for three-dimensional analysis are similar to those for two-dimensional analysis. The two orthogonal components within each pair must have the same scale factor, but the individual pairs may have different scale factors. Within 10 kilometers of a fault, ground motion components often are selected to represent fault-normal and fault-parallel directions, but this is not required. For certain structures, the response under both horizontal and vertical ground motions should be considered. It is noted, however, that vertical ground motion spectra are not readily available, so the scaling of the vertical components of ground motion would be problematic.

The 1.3 factor in the comparison of the average of the SRSS spectra to the design spectrum is intended to compensate for the increase associated with taking the SRSS of the two components of each ground motion pair. If the two components are perfectly correlated (identical response spectra in both directions), the SRSS would be larger than the average by the square root of 2. Because real ground motions are not perfectly correlated, a smaller factor is acceptable. The judgment of the writers (after two cycles of revision) is to allow a factor of 1.3 and to allow the results to be low by as much as 10 percent (producing an effective factor of 1.18).

Given a set of appropriate ground motions, there are an infinite number of scaling factors that may be applied to the individual motions to meet the requirements of Sections 16.1.3.1 and 16.1.3.2. Thus, two analysts, working with the same set of ground motions, are likely to produce a different set of scale factors. While this difference in scaling would have little impact in linear analysis, it may lead to vastly different results in nonlinear analysis. For this reason, the process of selection and scaling of ground motions should be included in the design review (Section 16.2.5 of the standard) that is required wherever nonlinear response history analysis is used.

Both amplitude scaling and spectral matching procedures can be used to satisfy the scaling technique specified in Sections 16.1.3.1 and 16.1.3.2. Both procedures provide reasonable estimates of mean response for the individual response parameters. Spectral matching can provide mean estimates with a smaller suite of motions, although seven suites are still required as outlined in Section 16.1.4. Neither scaling approach, however, is adequate to give an accurate estimate of the variability, although amplitude scaling gives a better understanding of the potential variability than spectral matching.

C16.1.4 Response Parameters. The responses derived from the response history analysis are multiplied by I to provide enhanced strength and stiffness for more important facilities, and are divided by R to account for inelastic behavior. For consistency with the ELF procedure and the MRS analysis procedure, the displacements computed from the response histories that have been further modified by I/R should be multiplied by C_d to obtain the displacement histories to use for computing the story drift histories. (The requirement to multiply displacements by C_d was incorrectly omitted in the standard.)

If for any ground motion the peak base shear is less than that computed from Equation 12.8-5 or 12.8-6, the entire response history must be scaled up such that the peak base shear is not less than that computed from Equation 12.8-5 or 12.8-6, as applicable. The base shear typically is computed from component elastic forces. A slightly different shear would be computed from the total inertial forces, with the difference being due to damping. Note that while the results of MRS

analysis must be scaled up such that the corresponding base shear is not less than 85 percent of the base shear that would be computed from an ELF analysis (see Section C12.9.4), the scaling for linear response history analysis considers only the applicable minimum base shear coefficient.

If seven or more ground motions are used, the design values may be taken as the average of the scaled values from the response history analysis. This provides some difficulty for components for which the capacity depends on multiple values. For a column, for example, both the axial force and the concurrent bending moment are needed to compare demand and capacity. In that instance, if seven or more ground motions are used, the column is deemed suitable if the average of the seven peak demand-to-capacity ratios for the column is less than 1.0. Where fewer than seven ground motions are used, the column is deemed suitable if the maximum demand-to-capacity ratio is less than 1.0.

The direction of loading requirements of Section 12.5 and the modeling requirements of Section 12.7 apply to response history analysis, but Chapter 16 of the standard does not address additional requirements such as accidental torsion, amplification of accidental torsion, or detailed consideration of P-delta effects. These effects should be included in a manner consistent with the requirements of Section 12.9.

C16.2 NONLINEAR RESPONSE HISTORY PROCEDURE

Nonlinear response history analysis is not used as part of the normal design process for typical structures. In some cases, however, nonlinear analysis is recommended, and in certain cases required, to obtain a more realistic assessment of structural response and verify the results of simpler methods of analysis. Such is the case for systems with friction-based passive energy dissipation devices, nonlinear viscous dampers, seismically isolated systems, self-centering systems, or systems that have components with highly irregular force-deformation relationships.

The principal aim of nonlinear response history analysis is to determine if the computed deformations of the structure are within appropriate limits. Strength requirements for the designated lateral load-resisting elements do not apply because element strengths are established prior to the analysis. These initial strengths typically are determined from a preliminary design using linear analysis.

The nonlinear response history analysis may also provide useful information on the strength requirements for nonstructural components, which are often assumed to remain elastic in the analysis.

Where displacements computed from the nonlinear response history analysis are excessive, a typical remedy is to increase the stiffness of the structure, which is likely to affect the computed strength.

Nonlinear response history analysis offers several advantages over linear response history analysis, including the ability to model a wide variety of nonlinear material behaviors, geometric nonlinearities (including large displacement effects), gap opening and contact behavior, and nonclassical damping, and to identify the likely spatial and temporal distributions of inelasticity. Nonlinear response history analysis has several disadvantages, including increased effort to develop the analytical model, increased time to perform the analysis (which is often complicated by difficulties in obtaining converged solutions), sensitivity of computed response to system parameters, and the inapplicability of superposition to combine live, dead, and seismic load effects.

C16.2.1 Analysis Requirements. Nonlinear response history analysis of structures with widely distributed inelastic behavior is usually carried out using the direct analysis approach (described in Section C16.1.1), wherein all equations are solved simultaneously at each time step. In some cases, it is possible to use a highly efficient nonlinear modal analysis approach called Fast Nonlinear Analysis, or FNA (Wilson, 2004). The class of nonlinear structures that may be analyzed by the FNA approach consists of structures with a very limited number of discrete sources of well-defined nonlinear behavior. Such structures include seismically isolated structures and structures with damping systems. Because of the limited applicability of FNA, this commentary discusses only the direct analysis approach.

The sensitivity of nonlinear response history analysis may be evidenced by results that appear to be chaotic or even counter-intuitive, although they may be correct. For example, it is possible for the analysis to predict that a structure collapses when subjected to a given ground motion, while surviving at higher intensity of the same motion. Similarly, the results from analyses of the same structure for several ground motions with similar spectral shapes and amplitudes often differ substantially. A systematic approach to assess the sensitivity of structures to different ground motions and structural system parameters, using Incremental Dynamic Analysis (IDA), is reported by Vamvatsikos (2002). The IDA method has become an important tool in earthquake engineering research.

C16.2.2 Modeling. Nonlinear response history analysis requires a mathematical description of the hysteretic behavior of those portions of the structure that are expected to exhibit inelastic behavior during an earthquake. Such models must reflect the expected properties, accounting for the following effects as appropriate:

1. Material overstrength and strain hardening
2. Cyclic degradation of stiffness and strength
3. In-cycle degradation of stiffness and strength (Applied Technology Council, 2009)
4. Pinching
5. Buckling
6. Axial-flexural-shear interaction

Most of the available mathematical models are phenomenological and represent yielding portions as distinct elements (such as plastic hinges). More exact analysis may be performed by subdividing yielding portions into a number of slices or fibers. This more exact approach is preferable but is more computationally demanding.

An inelastic three-dimensional analysis is particularly useful for buildings that are prone to torsional response in plan, even where the main seismic force-resisting systems resist loads predominantly in their own plane. If only two-dimensional software is available, a “pseudo” three-dimensional analysis may be performed (Mehrain and Naeim, 2003).

In moment resisting steel frames, the elastic and inelastic behavior of beam-column joint regions should be modeled explicitly. P-delta effects should be considered explicitly in the analysis. Nonstructural components also should be included in the model if it is expected that their stiffness and strength have a significant effect on the response.

Nonlinear response history analysis requires that inherent damping be set for the structure. As for linear response history analysis, nonlinear response history analysis typically is performed assuming inherent damping of 5 percent of critical. Some analysts and designers advocate the use of lower levels of inherent damping (perhaps 2 percent of critical), especially for steel frames, but there is no widespread agreement on this point.

The mechanism used to include inherent damping in the analytical model is critically important to the accuracy of the computed response. Most nonlinear analysis programs use a form of Rayleigh damping, wherein the damping matrix (used for direct integration of the equations of motion) is represented as a linear combination of the mass and stiffness matrices. (See Section C16.1.2.) If the damping matrix is based on the initial stiffness of the system, artificial damping may be generated by system yielding. In some cases, the artificial damping can completely skew the computed response (Chrisp, 1980; Carr, 2004; Charney, 2006; Hall, 2006). One method to counter this occurrence is to base the damping matrix on the mass and the instantaneous tangent stiffness. (Where basing the damping on tangent stiffness, care must be taken so that the damping is not negative when the tangent stiffness is negative.) Other approaches have been suggested, such as capped Rayleigh damping (Hall, 2006) and hysteretic damping (Charney, 2006). Several commercial programs, including SAP2000, Perform 2D, and Ruaomoko, provide for tangent stiffness-based damping.

Three-dimensional analysis must be used where certain plan irregularities are present. For structures composed of two-dimensional seismic force-resisting elements connected by floor and roof diaphragms, the diaphragms should be modeled as flexible in-plane, particularly where the vertical elements of the seismic force-resisting system are of different types (such as moment frames and walls). Where structures are modeled in three dimensions, axial force-biaxial bending interaction should be considered for corner columns, nonrectangular walls, and other similar elements.

As mentioned above, P-delta effects should be included where significant. The significance of P-delta effects on the overall response may be assessed by performing analyses with and without P-delta effects, and comparing story drift response histories. Destabilizing effects of gravity loads are often manifested by accumulated residual deformations, and these deformations, if not controlled, can lead to dynamic instability of the structure.

C16.2.3 Ground Motion and Other Loading. Since linear superposition cannot be used with nonlinear analysis, each response history analysis must begin with an initial gravity load, consisting of the expected dead load and live load. The live load may be as little as 25 percent of the unfactored design live load because multiple transient loads are unlikely to attain their maxima simultaneously.

C16.2.4 Response Parameters. As discussed above, the principal aim of nonlinear response history analysis is to determine deformation demands in structural and nonstructural components for comparison with accepted limits. Where at least seven ground motions are used, the member and connection deformations may be taken as the average of the values computed from the analyses. If fewer than seven motions are used, the maximum values among all analyses must be used. It is very important to note, however, that assessment of deformations in this manner should not be done without careful inspection of the story displacement histories of each analysis. It is possible that the maximum displacement or drift may be completely dominated by the response from one ground motion, and such dominance, when due to ratcheting (increasing deformations in one direction resulting in a high residual deformation), may be a sign of imminent dynamic instability. Where these kinds of dynamic instabilities are present, the analyst should attempt to determine the system characteristics that produce such effects. The ground motion that produces dynamic instability should not be replaced with one that does not.

C16.2.4.1 Member Strength. The strength design load combinations of Section 12.4 need not be assessed because linear combinations of load are not applicable in nonlinear analysis. Overstrength effects are evaluated directly since hysteretic force-deformation relationships are modeled explicitly and the material properties so used include overstrength and strain hardening (as required by Section 16.2.2).

C16.2.4.2 Member Deformation. This section requires that member and connection deformations be assessed on the basis of tests performed for similar configurations.

C16.2.4.3 Story Drift. The 25 percent increase in allowable story drift is provided because the nonlinear analysis is generally more accurate than linear analysis and because member deformations are assessed explicitly.

C16.2.5 Design Review. As discussed above, nonlinear response history analysis is quite complex, and the results may be strongly influenced by subtle changes in ground motion or system properties. Hence, such analysis must only be conducted by experienced professionals with training in engineering seismology, earthquake engineering, structural dynamics, stability, nonlinear analysis, and inelastic behavior of structures. Regardless of the level of expertise of the individual or individuals who perform the analysis and design, a design (peer) review of the structural system and the nonlinear analysis is required wherever the design is based on the nonlinear response history procedure.

REFERENCES

- Anderson, J. A, and V. V. Bertero. 1987. "Uncertainties in Establishing Design Earthquakes," *Journal of Structural Engineering*, 113(8):1709-1724.
- Applied Technology Council. 2009. *The Effects of Strength and Stiffness Degradation on Seismic Response*, FEMA P440A. FEMA, Washington, D.C.
- Carr, A. J. 2004. *Ruaumoko Users Manual*, Volume 1. Department of Civil Engineering, University of Canterbury, New Zealand.
- Charney, F. A. 2006. "Unintended Consequences of Modeling Damping in Structures," in *Proceedings of the 17th Analysis and Computation Conference*, ASCE, St. Louis, Missouri.
- Chrisp, D. J. 1980. Damping Models for Inelastic Structures, Master of Engineering Report, University of Canterbury, New Zealand.
- Hall, J. F. 2006. "Problems Encountered from the Use (or Misuse) of Rayleigh Damping," *Earthquake Engineering and Structural Dynamics*, 25(5):525-545.
- Iervolino, I., and A. Cornell. 2005. "Record Selection for Nonlinear Seismic Analysis of Structures," *Earthquake Spectra*, 21(3):685-714.
- Mehrain, M., and F. Naeim. 2003. "Exact Three Dimensional Linear and Nonlinear Seismic Analysis of Structures Using Two-Dimensional Models," *Earthquake Spectra*, 19(4):897-912.
- Naeim, F., A. Alimoradi, and S. Pezeshk. 2004. "Selection and Scaling of Ground Motion Time Histories for Structural Design using Genetic Algorithms," *Earthquake Spectra*, 20(2):413-426.
- Shome, N., and A. Cornell. 1998. "Normalization and Scaling Accelerograms for Nonlinear Analysis," in *Proceedings of the 6th U.S. National Conference on Earthquake Engineering*. Earthquake Engineering Research Institute.
- Shome, N., A. Cornell, P. Bazzurro, and J. E. Carballo. 1998. "Earthquakes, Records, and Nonlinear Response," *Earthquake Spectra*, 14(3):469-500.
- Somerville, P., Anderson, D., Sun, J., Punyamurthula, S., and Smith, N., 1998 Generation of Ground Motion Time Histories for Performance Based Seismic Engineering," *Proceedings of the 6th U.S. National Conference on Earthquake Engineering*, Earthquake Engineering Research Institute.
- Vamvatsikos, D. 2002. Seismic Performance, Capacity and Reliability of Structures As Seen Through Incremental Dynamic Analysis, Ph.D. Dissertation, Department of Civil and Environmental Engineering, Stanford University, Palo Alto, California.
- Wilson, E. L., and J. Penzien. 1970. "Evaluation of Orthogonal Damping Matrices," *International Journal for Numerical Methods in Engineering*, 4:5-10.
- Wilson, E. L., A. Der Kiureghian, and E. Bayo. 1981. "A Replacement for the SRSS Method in Seismic Analysis," *Earthquake Engineering and Structural Dynamics*, 9:192.
- Wilson, E. L., M. Yuan, and J. Dickens. 1982. "Dynamic Analysis by Direct Superposition of Ritz Vectors," *Earthquake Engineering and Structural Dynamics*, 10:813-823.
- Wilson, E. L. 2004. *Static and Dynamic Analysis of Structures*, 4th Edition. Computers and Structures, Inc., Berkeley, California.

COMMENTARY TO CHAPTER 17, SEISMIC DESIGN REQUIREMENTS FOR SEISMICALLY ISOLATED STRUCTURES

C17.1 GENERAL

Seismic isolation, commonly referred to as base isolation, is a method used to decouple substantially the response of a structure from potentially damaging earthquake motions. This decoupling can result in response that is reduced significantly from that of a conventional, fixed-base building.

The potential advantages of seismic isolation and the recent advancements in isolation-system technology have led to the design and construction of a large number of seismically isolated buildings and bridges in the United States.

Design requirements for seismically isolated structures were first codified in the United States as an appendix to the 1991 *Uniform Building Code*, based on “General Requirements for the Design and Construction of Seismic-Isolated Structures” developed by the Structural Engineers Association of California State Seismology Committee. In the intervening years, those provisions have developed along two parallel tracks into the design requirements in Chapter 17 of the standard and the rehabilitation requirements in Section 9.2 of ASCE/SEI 41, *Seismic Rehabilitation of Existing Buildings*. The design and analysis methods of both standards are quite similar, but ASCE/SEI 41 permits more liberal design for the superstructure of rehabilitated buildings. The AASHTO *Guide Specification for Seismic Isolation Design* provides a systematic approach to determining bounding values of mechanical properties of isolators for analysis and design. Rather than addressing a specific method of seismic isolation, the standard provides general design requirements applicable to a wide range of possible seismic isolation systems. Because the design requirements are general, testing of isolation-system hardware is required to confirm the engineering parameters used in the design and to verify the overall adequacy of the isolation system. Use of isolation systems whose adequacy is not proved by testing is prohibited. In general, acceptable systems: (a) remain stable when subjected to design displacements, (b) provide increasing resistance with increasing displacement, (c) do not degrade under repeated cyclic load, and (d) have quantifiable engineering parameters (such as force-deflection characteristics and damping).

The force-deflection behavior of isolation systems falls into four categories, as shown in Figure C17.1-1, where each idealized curve has the same design displacement, D_D . A linear isolation system (Curve A) has an effective period independent of displacement, and the force generated in the superstructure is directly proportional to the displacement of the isolation system.

with increasing displacement, the procedures of the standard cannot be applied, and use of the system is prohibited.

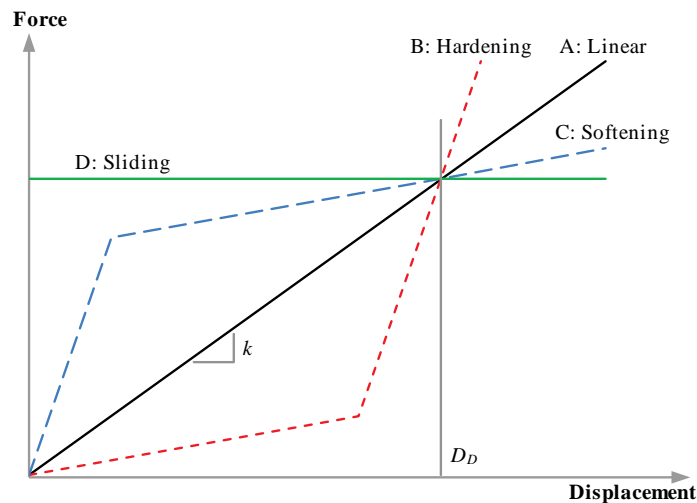

Figure C17.1-1 Idealized force-deflection relationships for isolation systems (stiffness effects of sacrificial wind-restraint systems not shown for clarity).

A hardening isolation system (Curve B) is soft initially (long effective period) and then stiffens (effective period shortens) as displacement increases. Where displacements exceed the design displacement, the superstructure is subjected to larger forces and the isolation system to smaller displacements than for a comparable linear system.

A softening isolation system (Curve C) is stiff initially (short effective period) and then softens (effective period lengthens) as displacement increases. Where displacements exceed the design displacement, the superstructure is subjected to smaller forces and the isolation system to larger displacements than for a comparable linear system.

The response of a purely sliding isolation system (Curve D) is governed by the friction force at the sliding interface. For increasing displacement, the effective period lengthens, and loads on the superstructure remain constant. For isolation systems governed solely by friction forces, the total displacement due to repeated earthquake cycles is highly dependent on the characteristics of the ground motion and may exceed the design displacement, D_D . Since such systems do not have increasing resistance

Chapter 17 provides isolator design displacements, shear forces for structural design, and other specific requirements for seismically isolated structures. All other design requirements, including loads (other than seismic), load combinations, allowable forces and stresses, and horizontal shear distribution, are the same as those for conventional, fixed-base structures.

C17.1.1 Variations in Material Properties. For analysis, the mechanical properties of seismic isolators generally are based on values provided by isolator manufacturers. Values of the mechanical properties should be in the range that accounts for natural variability and uncertainty, and variability of properties among isolator of different manufacturers. Examples may be found in Constantinou et al. (2007b). Prototype testing is used to confirm the values assumed for design. Unlike conventional materials whose properties do not vary substantially with time, the materials used in seismic isolators have properties that generally will vary with time. Because mechanical properties can vary over the life of a structure and the testing protocol of Section 17.8 cannot account for the effects of aging, contamination, scragging (temporary degradation of mechanical properties with repeated cycling), temperature, velocity effects, and wear, the designer must account for these effects by explicit analysis. One approach to accommodate these effects, introduced in Constantinou et al. (1999), is to use property modification factors. Information on variations in material properties of seismic isolators and dampers is reported in Constantinou et al. (2007).

C17.2 GENERAL DESIGN REQUIREMENTS

Ideally, most of the lateral displacement of an isolated structure will be accommodated by deformation of the isolation system rather than distortion of the structure above. Accordingly, the seismic-force-resisting system of the structure above the isolation system is designed to have sufficient stiffness and strength to avoid large, inelastic displacements. Therefore, the standard contains criteria that limit the inelastic response of the structure above the isolation system. Although damage control is not an explicit objective of the standard, design to limit inelastic response of the structural system also will reduce the level of damage that would otherwise occur during an earthquake. In general, isolated structures designed in accordance with the standard are expected:

1. To resist minor and moderate levels of earthquake ground motion without damage to structural elements, nonstructural components, or building contents and
2. To resist major levels of earthquake ground motion without failure of the isolation system, significant damage to structural elements, extensive damage to nonstructural components, or major disruption to facility function.

Isolated structures are expected to perform much better than fixed-base structures during moderate and major earthquakes. Table C17.2-1 compares the performance expected for isolated and fixed-base structures designed in accordance with the standard.

Table C17.2-1 Performance Expected for Minor, Moderate, and Major Earthquakes^a

Performance Measure	Earthquake Ground Motion Level		
	Minor	Moderate	Major
Life safety: loss of life or serious injury is not expected	F, I	F, I	F, I
Structural damage: significant structural damage is not expected	F, I	F, I	I
Nonstructural damage: significant nonstructural or contents damage is not expected	F, I	I	I

^a F indicates fixed base; I indicates isolated.

Loss of function is not included in Table C17.2-1. For certain fixed-base facilities, loss of function would not be expected unless there is significant structural damage causing closure or restricted access to the building. In other cases, a facility with only limited or no structural damage would not be functional as a result of damage to vital nonstructural components or contents. Isolation would be expected to mitigate structural and nonstructural damage and to protect the facility against loss of function.

C17.2.4 Isolation System

C17.2.4.1 Environmental Conditions. Environmental conditions that may adversely affect isolation system performance must be investigated thoroughly. Related research has been conducted since the 1970s in Europe, Japan, New Zealand, and the United States.

C17.2.4.2 Wind Forces. Lateral displacement over the depth of the isolator zone resulting from wind loads must be limited to a value similar to that required for other story heights.

C17.2.4.3 Fire Resistance. While fire may adversely affect the lateral performance of the isolation system, its gravity-load resistance must be maintained as required for other elements of the structure.

C17.2.4.4 Lateral Restoring Force. The restoring-force requirement is intended to limit residual displacement as a result of an earthquake, so that the isolated structure will survive aftershocks and future earthquakes.

C17.2.4.5 Displacement Restraint. The use of a displacement restraint is discouraged. Where a displacement restraint system is used, explicit analysis of the isolated structure for maximum considered earthquake response is required to account for the effects of engaging the displacement restraint.

C17.2.4.6 Vertical-load Stability. The vertical loads to be used in checking the stability of any given isolator should be calculated using bounding values of dead load and live load and the peak earthquake demand of the maximum considered earthquake. Since earthquake loads are reversible in nature, peak earthquake load should be combined with bounding values of dead and live load in a manner which produces both the maximum downward force and the maximum upward force on any isolator. Stability of each isolator should be verified for these two extreme values of vertical load at peak maximum considered earthquake displacement of the isolation system.

C17.2.4.7 Overturning. The intent of this requirement is to prevent both global structural overturning and overstress of elements due to local uplift. Isolator uplift is acceptable so long as the isolation system does not disengage from its horizontal-resisting connection detail. The connection details used in some isolation systems are such that tension is not permitted on the system. Where the tension capacity of an isolator is used to resist uplift forces, design and testing in accordance with Sections 17.2.4.6 and 17.8.2.5 must be performed to demonstrate the adequacy of the system to resist tension forces at the total maximum displacement.

C17.2.4.8 Inspection and Replacement. Although most isolation systems will not need to be replaced after an earthquake, access for inspection and replacement must be provided, and periodic inspection is required. After an earthquake, the isolation system should be inspected and any damaged elements replaced or repaired.

C17.2.4.9 Quality Control. A testing and inspection program is necessary for both fabrication and installation of the isolator units. Because seismic isolation is a rapidly evolving technology, it may be difficult to reference standards for testing and inspection. Reference can be made to standards for some materials, such as elastomeric bearings (ASTM D 4014). Similar standards are yet to be developed for other isolation systems. Special inspection procedures and load testing to verify manufacturing quality must be developed for each project. The requirements will vary depending on the type of isolation system used.

C17.2.5 Structural System

C17.2.5.2 Building Separations. A minimum separation between the isolated structure and rigid obstructions is required to allow free movement of the superstructure in all lateral directions during an earthquake.

C17.2.6 Elements of Structures and Nonstructural Components. To accommodate the differential movement between the isolated building and the ground, flexible utility connections are required. In addition, stiff elements crossing the isolation interface (such as stairs, elevator shafts, and walls) must be detailed to accommodate the total maximum displacement without compromising life safety.

C17.3 GROUND MOTION FOR ISOLATED STRUCTURES

C17.3.1 Design Spectra. Seismically isolated structures located on Site Class F sites and on sites with $S_I \geq 0.6$ must be analyzed using response history analysis. For those cases, the response spectra must be site-specific in order to account, in

the analysis, for near-fault effects and for soft soil conditions, both of which are known to be important in the assessment of displacement demands in seismically isolated structures.

C17.3.2 Ground Motion Histories. The selection and scaling of ground motions for response history analysis requires fitting to the response spectra in the period range of $0.5T_D$ to $1.25T_M$, a range that is different from that for conventional structures $0.2T$ to $1.5T$. The following sections provide background on the two period ranges:

1. **Period Range – Isolated Structures.** The effective (fundamental) period of an isolated structure is based on amplitude-dependent, nonlinear (pushover) stiffness properties of the isolation system. The effective periods, T_D and T_M , correspond to design earthquake displacement and maximum considered earthquake displacement, respectively, in the direction under consideration. Values of effective (fundamental) periods, T_D and T_M , are typically in the range of 2 to 4 seconds, and the value of the effective period, T_D , typically is 15 to 25 percent less than the corresponding value of effective period, T_M .

The response of an isolated structure is dominated by the fundamental mode in the direction of interest. The specified period range, $0.5T_D$ to $1.25T_M$, conservatively bounds amplitude-dependent values of the effective (fundamental) period of the isolated structure in the direction of interest, considering that individual earthquake records can affect response at effective periods somewhat longer than T_M , or significantly shorter than T_D .

2. **Period Range – Conventional, Fixed-Base Structures.** The fundamental period, T , of a conventional, fixed-base structure is based on amplitude-independent, linear-elastic stiffness properties of the structure. In general, response of conventional, fixed-base structures is influenced by both the fundamental mode and higher modes in the direction under consideration. The period range, $0.2T$ to $1.5T$, is intended to bound the fundamental period, considering some period lengthening due to nonlinear response of the structure (that is, inelastic periods up to $1.5T$) and periods corresponding to the more significant higher modes (that is, second and possibly third modes in the direction of interest).

C17.4 ANALYSIS PROCEDURE SELECTION

Three different analysis procedures are available for determining design-level seismic loads: the equivalent lateral force procedure, the response spectrum procedure, and the response history procedure. For the first procedure simple, lateral-force formulas (similar to those for conventional, fixed-base structures) are used to determine peak lateral displacement and design forces as a function of spectral acceleration and isolated-structure period and damping. For the second and third procedures, which are required for geometrically complex or especially flexible buildings, dynamic analysis (either the response spectrum procedure or the response history procedure) is used to determine peak response of the isolated structure.

The three procedures are based on the same level of seismic input and require a similar level of performance from the building. Where more complex analysis procedures are used, slightly lower design forces and displacements are permitted. The design requirements for the structural system are based on the design earthquake, taken as two-thirds of the maximum considered earthquake. The isolation system—including all connections, supporting structural elements, and the “gap”—is required to be designed (and tested) for 100 percent of maximum considered earthquake demand. Structural elements above the isolation system are not required to be designed for the full effects of the design earthquake but may be designed for slightly reduced loads (that is, loads reduced by a factor of up to 2) if the structural system is able to respond inelastically without sustaining significant damage. A similar fixed-base structure would be designed for loads reduced by a factor of 8 rather than 2.

This section delineates the requirements for the use of the equivalent lateral force procedure and dynamic methods of analysis. The limitations on the simplified lateral-force design procedure are quite restrictive. Limitations relate to the site location with respect to major, active faults; soil conditions of the site; the height, regularity, and stiffness characteristics of the building; and selected characteristics of the isolation system. Response-history analysis is required to determine the design displacement of the isolation system (and the structure above) for the following isolated structures:

1. Isolated structures with a “nonlinear” isolation system including, but not limited to, isolation systems with effective damping values greater than 30 percent of critical, isolation systems incapable of producing a significant restoring force, and isolation systems that restrain or limit extreme earthquake displacement; and
2. Isolated structures located on a Class E or Class F site (that is, a soft soil site that amplifies long-period ground motions).

Lower-bound limits on isolation system design displacements and structural-design forces are specified by the standard in Section 17.6 as a percentage of the values prescribed by the equivalent lateral force procedure, even where dynamic analysis is used as the basis for design. These lower-bound limits on key design parameters provide consistency in the design of

isolated structures and serve as a “safety net” against gross underdesign. Table C17.4-1 provides a summary of the lower-bound limits on dynamic analysis specified by the standard.

C17.5 EQUIVALENT LATERAL FORCE PROCEDURE

C17.5.3 Minimum Lateral Displacements. The lateral displacement given by Equation 17.5-1 approximates peak design earthquake displacement of a single-degree-of-freedom, linear-elastic system of period, T_D , and equivalent viscous damping, β_D . Similarly, the lateral displacement given by Equation 17.5-3 approximates peak maximum considered earthquake displacement of a single-degree-of-freedom, linear-elastic system of period, T_M , and equivalent viscous damping, β_M .

Table C17.4-1 Lower-Bound Limits on Dynamic Procedures Specified in Relation to ELF Procedure Requirements

Design Parameter	ELF Procedure	Dynamic Procedure	
		Response Spectrum	Response History
Design displacement – D_D	$D_D = (g/4\pi^2)(S_{D1}T_D/B_D)$	—	—
Total design displacement - D_{TD}	$D_{TD} \geq 1.1D_D$	$\geq 0.9D_{TD}$	$\geq 0.9D_{TD}$
Maximum displacement – D_M	$D_M = (g/4\pi^2)(S_{M1}T_M/B_M)$	—	—
Total maximum displacement - D_{TM}	$D_{TM} \geq 1.1D_M$	$\geq 0.8D_{TM}$	$\geq 0.8D_{TM}$
Design shear – V_b (at or below the isolation system)	$V_b = k_{Dmax}D_D$	$\geq 0.9V_b$	$\geq 0.9V_b$
Design shear – V_s ("regular" superstructure)	$V_s = k_{Dmax}D_D/R_I$	$\geq 0.8V_s$	$\geq 0.6V_s$
Design shear – V_s ("irregular" superstructure)	$V_s = k_{Dmax}D_D/R_I$	$\geq 1.0V_s$	$\geq 0.8V_s$
Drift (calculated using R_I for C_d)	$0.015h_{sx}$	$0.015h_{sx}$	$0.020h_{sx}$

Equation 17.5-1 is an estimate of peak displacement in the isolation system for the design earthquake. In this equation, the spectral acceleration term, S_{D1} , is the same as that required for design of a conventional, fixed-base structure of period, T_D . A damping term, B_D , is used to decrease (or increase) the computed displacement where the equivalent damping coefficient of the isolation system is greater (or smaller) than 5 percent of critical damping. Values of coefficient B_D (or B_M for the maximum considered earthquake) are given in Table 17.5-1 for different values of isolation system damping, β_D (or β_M).

A comparison of values obtained from Equation 17.5-1 and those obtained from nonlinear time-history analyses are given in Kircher et al. (1988) and Constantinou et al. (1993).

Consideration should be given to possible differences in the properties used for design of the isolation system and those of the isolation system as installed in the structure. Similarly, consideration should be given to possible changes in isolation system properties due to different design conditions or load combinations. If the true deformational characteristics of the isolation system are not stable or if they vary with the nature of the load (being rate-, amplitude-, or time-dependent), the design displacements should be based on deformational characteristics of the isolation system that give the largest possible deflection (k_{Dmin}), the design forces should be based on deformational characteristics of the isolation system that give the largest possible force (k_{Dmax}), and the damping level used to determine design displacements and forces should be based on deformational characteristics of the isolation system that represent the minimum amount of energy dissipated during cyclic response at the design level.

The isolation system for a seismically isolated structure should be configured to minimize eccentricity between the center of mass of the superstructure and the center of rigidity of the isolation system. In this way, the effect of torsion on the displacement of isolation elements will be reduced. As for conventional structures, allowance must be made for accidental eccentricity in both horizontal directions. Figure C17.5-1 illustrates the terminology used in the standard. Equation 17.5-5 (or Equation 17.5-6 for the maximum considered earthquake) provides a simplified formula for estimating the response due to torsion in lieu of a more refined analysis. The additional component of displacement due to torsion increases the design displacement at the corner of a structure by about 15 percent (for one perfectly square in plan) to about 30 percent (for one very long and rectangular in plan) if the eccentricity is 5 percent of the maximum plan dimension. These calculated torsional

displacements are for structures with an isolation system whose stiffness is uniformly distributed in plan. Isolation systems that have stiffness concentrated toward the perimeter of the structure, or certain sliding systems that minimize the effects of mass eccentricity, will have smaller torsional displacements. The standard permits values of D_{TD} as small as $1.1D_D$, with proper justification.

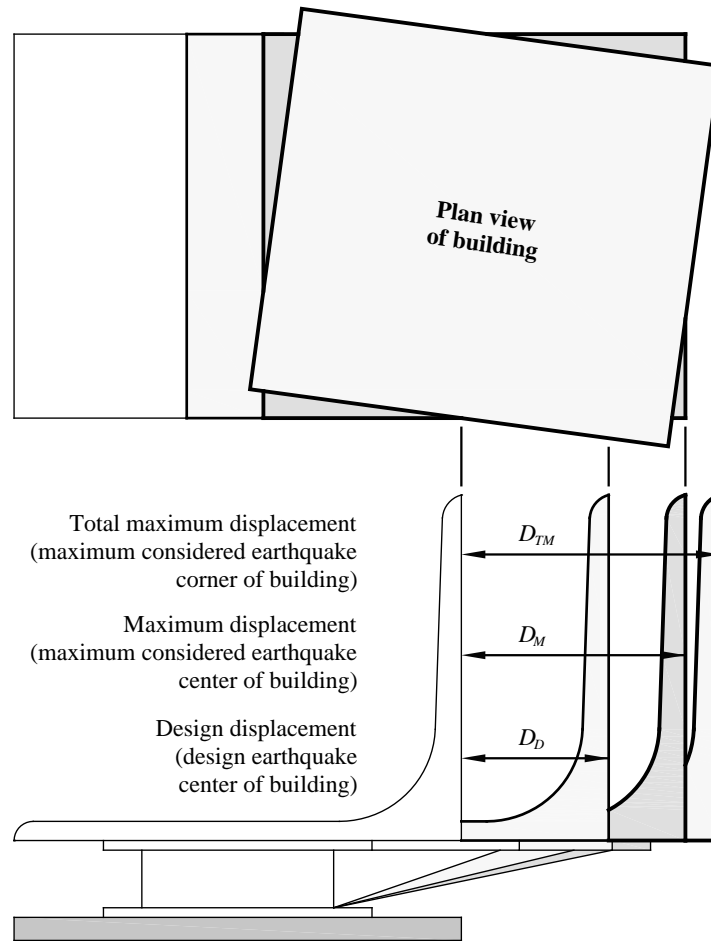

Figure C17.5-1 Displacement terminology.

C17.5.4 Minimum Lateral Forces. Figure C17.5-2 illustrates the terminology for elements at, below, and above the isolation system. Equation 17.5-7 specifies the peak seismic shear for design of all structural elements at or below the isolation system (without reduction for ductile response). Equation 17.5-8 specifies the peak seismic shear for design of structural elements above the isolation system. For structures that have appreciable inelastic-deformation capability, this equation includes an effective reduction factor of up to 2 for response beyond the strength-design level.

The reduction factor is based on use of strength-design procedures. A factor of at least 2 is assumed to exist between the design-force level and the true-yield level of the structural system. An investigation of 10 specific buildings indicated that this factor varied between 2 and 5 (ATC, 1982). Thus, a reduction factor of 2 is appropriate to produce a structural system that remains essentially elastic for the design earthquake.

In Section 17.5.4.3, the limits given on V_S provide at least a factor of 1.5 between the nominal yield level of the superstructure and (a) the yield level of the isolation system, (b) the ultimate capacity of a sacrificial wind-restraint system that is intended to fail and release the superstructure during significant lateral load, or (c) the break-away friction level of a sliding system.

These limits are needed so that the superstructure will not yield prematurely before the isolation system has been activated and significantly displaced.

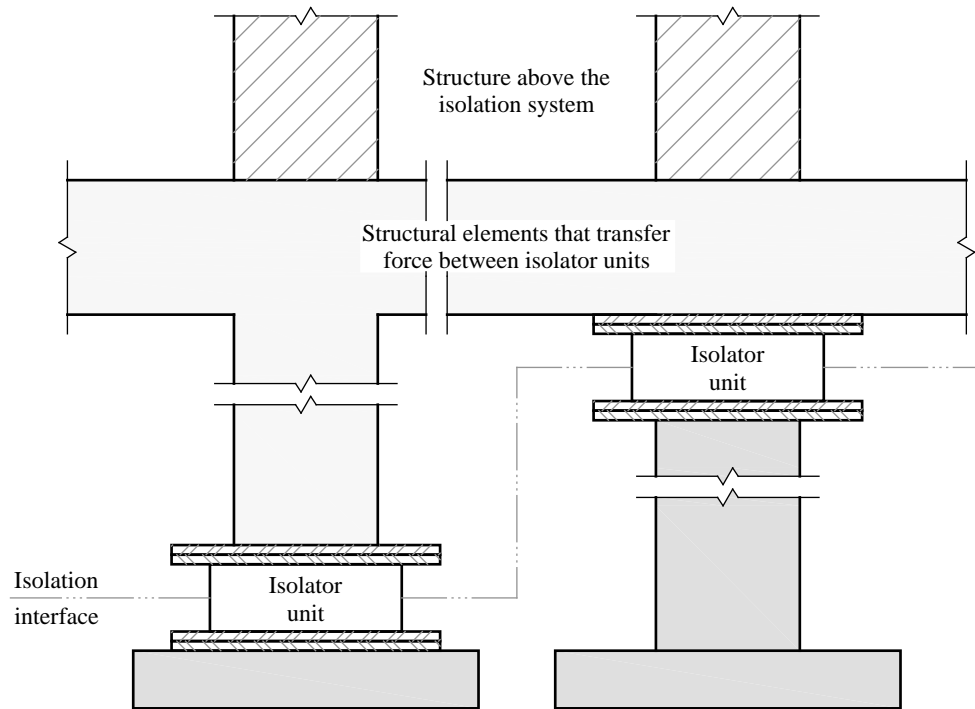

Figure C17.5-2 Isolation system terminology.

The design shear force, V_s , specified in this section results in an isolated structural system being subjected to significantly lower inelastic demands than a conventionally designed structural system. Further reduction in V_s , such that the inelastic demand on a seismically isolated structure would be the same as the inelastic demand on a conventionally designed structure, was not considered during development of these requirements but may be considered in the future.

Using a smaller value of R_f in Equation 17.5-8 will reduce or eliminate inelastic response of the superstructure for the design-basis event, thus further improving the structural performance.

C17.5.5 Vertical Distribution of Forces. Equation 17.5-9 produces a vertical distribution of lateral forces consistent with a triangular profile of seismic acceleration over the height of the structure above the isolation interface. Kircher et al. (1988) and Constantinou et al. (1993) show that Equation 17.5-9 provides a conservative estimate of the distributions obtained from more detailed, nonlinear analysis studies for the type of structures for which use of Equation 17.5-9 is allowed.

C17.5.6 Drift Limits. The maximum story drift permitted for design of isolated structures is constant for all Occupancy Categories, as shown in Table C17.5-1. For comparison, the drift limits prescribed by the standard for fixed-base structures also are summarized in that table.

Table C17.5-1 Comparison of Drift Limits for Fixed-Base and Isolated Structures

Structure	Occupancy Category	Fixed-Base	Isolated
Buildings (other than masonry) four stories or less in height with component drift design	I or II	$0.025h_{sx}/(C_d/R)$	$0.015h_{sx}$
	III	$0.020h_{sx}/(C_d/R)$	$0.015h_{sx}$
	IV	$0.015h_{sx}/(C_d/R)$	$0.015h_{sx}$
Other (non-masonry) buildings	I or II	$0.020h_{sx}/(C_d/R)$	$0.015h_{sx}$
	III	$0.015h_{sx}/(C_d/R)$	$0.015h_{sx}$
	IV	$0.010h_{sx}/(C_d/R)$	$0.015h_{sx}$

Drift limits in Table C17.5-1 are divided by C_d/R for fixed-base structures since displacements calculated for lateral loads reduced by R are multiplied by C_d before checking drift. The C_d term is used throughout the standard for fixed-base structures to approximate the ratio of actual earthquake response to response calculated for “reduced” forces. Generally, C_d

is 1/2 to 4/5 the value of R . For isolated structures, the R_I factor is used both to reduce lateral loads and to increase displacements (calculated for reduced lateral loads) before checking drift. Equivalency would be obtained if the drift limits for both fixed-base and isolated structures were based on their respective R factors. It may be noted that the drift limits for isolated structures generally are more conservative than those for conventional, fixed-base structures, even where fixed-base structures are assigned to Occupancy Category IV.

C17.6 DYNAMIC ANALYSIS PROCEDURES

This section specifies the requirements and limits for dynamic procedures. The design displacement and force limits on response spectrum and response history procedures are shown in Table C17.4-1.

A more detailed or refined study can be performed in accordance with the analysis procedures described in this section. The intent of this section is to provide procedures that are compatible with the minimum requirements of Section 17.5. Reasons for performing a more refined study include:

1. The importance of the building.
2. The need to analyze possible structure/isolation-system interaction where the fixed-base period of the building is greater than one-third of the isolated period.
3. The need to explicitly model the deformational characteristics of the lateral-force-resisting system where the structure above the isolation system is irregular.
4. The desirability of using site-specific ground-motion data, especially for very soft or liquefiable soils (Site Class F) or for structures located where S_I is greater than 0.60.
5. The desirability of explicitly modeling the deformational characteristics of the isolation system. This is especially important for systems that have damping characteristics that are amplitude-dependent, rather than velocity-dependent, since it is difficult to determine an appropriate value of equivalent viscous damping for these systems.

Section C17.4 discusses other conditions that require use of the response history procedure. As shown in Table C17.4-1, the drift limit for isolated structures is relaxed where story drifts are computed using nonlinear response history analysis.

Where response history analysis is used as the basis for design, the design displacement of the isolation system and design forces in elements of the structure above are computed from not fewer than three separate analyses, each using a different ground motion selected and scaled in accordance with Section 17.3.2. Where the configuration of the isolation system or of the superstructure is not symmetric, additional analyses are required to satisfy the requirement of Section 17.6.3.4 to consider the most disadvantageous location of eccentric mass. As appropriate, near-field phenomena may also be incorporated. As in the nuclear industry, where at least seven ground motions are used for nonlinear response history analysis, it is considered appropriate to base design of seismically isolated structures on the average value of the response parameters of interest.

C17.7 DESIGN REVIEW

Review of the design and analysis of the isolation system and design review of the isolator testing program is mandated by the standard for two key reasons:

1. The consequences of isolator failure could be catastrophic.
2. Isolator design and fabrication technology is evolving rapidly and may be based on technologies unfamiliar to many design professionals.

The standard requires review to be performed by a team of registered design professionals that are independent of the design team and other project contractors. The review team should include individuals with special expertise in one or more aspects of the design, analysis, and implementation of seismic isolation systems.

The review team should be formed prior to the development of design criteria (including site-specific ground shaking criteria) and isolation system design options. Further, the review team should have full access to all pertinent information and the cooperation of the design team and regulatory agencies involved with the project.

C17.8 TESTING

The design displacements and forces determined using the standard assume that the deformational characteristics of the isolation system have been defined previously by comprehensive testing. If comprehensive test data are not available for a system, major design alterations in the structure may be necessary after the tests are complete. This would result from

variations in the isolation-system properties assumed for design and those obtained by test. Therefore, it is advisable that prototype systems be tested during the early phases of design, if sufficient test data are not available on an isolation system.

Typical force-deflection (or hysteresis) loops are shown in Figure C17.8-1; also illustrated are the values defined in Section 17.8.5.1.

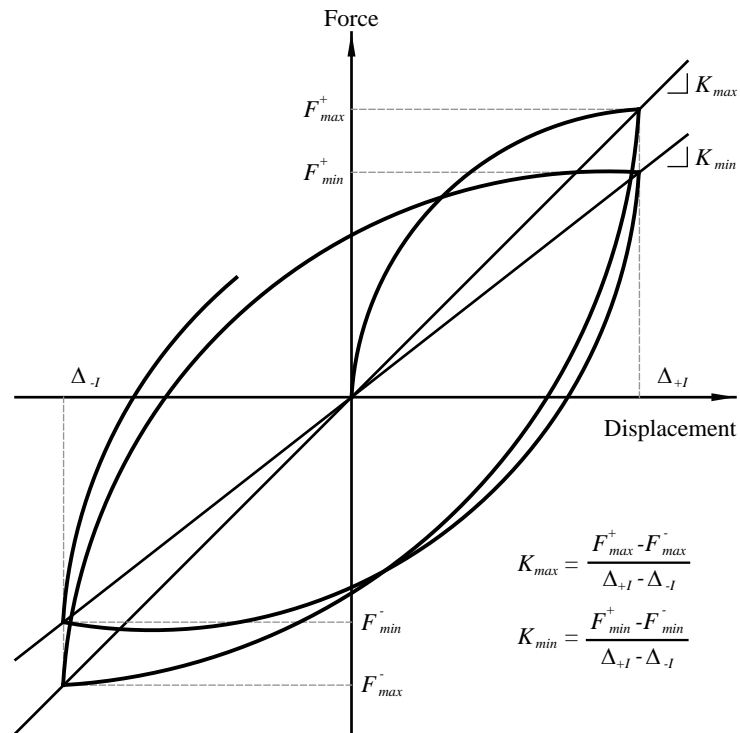

Figure C17.8-1 The effect of stiffness on an isolation bearing.

The required sequence of tests will verify experimentally the following:

1. The assumed stiffness and capacity of the wind-restraining mechanism;
2. The variation of the isolator's deformational characteristics with amplitude (and with vertical load, if it is a vertical load-carrying member);
3. The variation of the isolator's deformational characteristics for a realistic number of cycles of loading at the design displacement; and
4. The ability of the system to carry its maximum and minimum vertical loads at the maximum displacement.

Force-deflection tests are not required if similarly sized components have been tested previously using the specified sequence of tests.

The variations in the vertical loads required for tests of isolators which carry vertical, as well as lateral, load are necessary to determine possible variations in the system properties with variations in overturning force.

C17.8.5 Design Properties of the Isolation System

C17.8.5.1 Maximum and Minimum Effective Stiffness. The effective stiffness is determined from the hysteresis loops as shown in Figure C17.8-1. Stiffness may vary considerably as the test amplitude increases but should be reasonably stable (within 15 percent) for more than three cycles at a given amplitude.

The intent of these requirements is that the deformational properties used in design result in the maximum design forces and displacements. For determining design displacement, this means using the smallest damping and effective stiffness values. For determining design forces, this means using the smallest damping value and the largest stiffness value.

C17.8.5.2 Effective Damping. The determination of equivalent viscous damping is reasonably reliable for systems whose damping characteristics are velocity dependent. For systems that have amplitude-dependent energy-dissipating mechanisms,

significant problems arise in determining an equivalent viscous-damping value. Since it is difficult to relate velocity- and amplitude-dependent phenomena, it is recommended that where the equivalent-viscous damping assumed for the design of amplitude-dependent energy-dissipating mechanisms (such as pure-sliding systems) is greater than 30 percent, the design-basis force and displacement be determined using the response history procedure, as discussed in Section C17.4.

REFERENCES

Applied Technology Council. 1982. *An Investigation of the Correlation between Earthquake Ground Motion and Building Performance*, ATC Report 10. ATC, Redwood City, California.

Association of State Highway and Transportation Officials. 1999. *Guide Specification for Seismic Isolation Design*. AASHTO, Washington, D.C.

Constantinou, M. C., C. W. Winters, and D. Theodossiou. 1993. "Evaluation of SEAOC and UBC analysis procedures, Part 2: Flexible superstructure," in *Proceedings of a Seminar on Seismic Isolation, Passive Energy Dissipation and Active Control*, ATC Report 17-1. ATC, Redwood City, California.

Constantinou, M. C., P. Tsopelas, A. Kasalanati, and E. D. Wolff. 1999. "Property modification factors for seismic isolation bearings," MCEER-99-0012. Multidisciplinary Center for Earthquake Engineering Research, Buffalo, New York.

Constantinou, M. C., A. S. Whittaker, Y. Kalpakidis, D. M. Fenz, and G. P. Warn. 2007. "Performance of seismic isolation hardware under service and seismic loading," MCEER-07-0012. Multidisciplinary Center for Earthquake Engineering Research, Buffalo, New York.

International Code Council. 2006. *International Building Code*. ICC, Washington, D.C.

Kircher, C. A., B. Lashkari, R. L. Mayes, and T. E. Kelly. 1988. "Evaluation of nonlinear response in seismically isolated buildings," in *Proceedings of a Symposium on Seismic, Shock and Vibration Isolation*, ASME PVP Conference.

Lashkari, B., and C. A. Kircher. 1993. "Evaluation of SEAOC & UBC analysis procedures, Part 1: stiff superstructure," in *Proceedings of a Seminar on Seismic Isolation, Passive Energy Dissipation and Acti.:* ATC.

COMMENTARY TO CHAPTER 18, SEISMIC DESIGN REQUIREMENTS FOR STRUCTURES WITH DAMPING SYSTEMS

C18.1 GENERAL

The requirements of this chapter apply to all types of damping systems including both displacement-dependent damping devices of hysteretic or friction systems and velocity-dependent damping devices of viscous or visco-elastic systems (Soong and Dargush, 1997; Constantinou et al., 1998; Hanson and Soong, 2001). Compliance with these requirements is intended to produce performance comparable to that for a structure with a conventional seismic-force-resisting system, but the same methods can be used to achieve higher performance.

The damping system (DS) is defined separately from the seismic-force-resisting system (SFRS), although the two systems may have common elements. As illustrated in Figure C18.1-1, the damping system may be external or internal to the structure and may have no shared elements, some shared elements, or all elements in common with the seismic-force-resisting system. Elements common to the damping system and the seismic-force-resisting system must be designed for a combination of the two loads of the two systems. When the DS and SFRS have no common elements, the damper forces must be collected and transferred to members of the SFRS.

C18.2 GENERAL DESIGN REQUIREMENTS

C18.2.2 System Requirements. Structures with a damping system must have a seismic-force-resisting system that provides a complete load path. The seismic-force-resisting system must comply with all of the height, Seismic Design Category, and redundancy limitations and with the detailing requirements specified in this standard for the specific seismic-force-resisting system. The seismic-force-resisting system without the damping system (as if damping devices were disconnected) must be designed to have not less than 75 percent of the strength required for undamped structures having that type of seismic-force-resisting system (and not less than 100 percent if the structure is horizontally or vertically irregular). The damping systems, however, may be used to meet the drift limits (whether the structure is regular or irregular). Having the SFRS designed for a minimum of 75 percent of the strength required for undamped structures provides safety in the event of damping system malfunction and produces a composite system with sufficient stiffness and strength to have controlled lateral displacement response.

The damping system must be designed for the actual (unreduced) earthquake forces (such as, peak force occurring in damping devices) and deflections. For certain elements of the damping system (such as the connections or the members into which the damping devices frame), other than damping devices, limited yielding is permitted provided such behavior does not affect damping system function or exceed the amount permitted for elements of conventional structures by the standard.

C18.2.4 Procedure Selection. Linear static and response spectrum analysis methods can be used for design of structures with damping systems that meet certain configuration and other limiting criteria (for example, at least two damping devices at each story configured to resist torsion). In such cases, additional nonlinear response history analysis shall be used to confirm peak responses when the structure is located at a site with S_1 greater than or equal to 0.6. The analysis methods for damped structures are based on nonlinear static “pushover” characterization of the structure and calculation of peak response using effective (secant) stiffness and effective damping properties of the first (pushover) mode in the direction of interest. These are the concepts used in Chapter 17 to characterize the force-deflection properties of isolation systems, modified to incorporate explicitly the effects of ductility demand (post-yield response) and higher-mode response of structures with dampers. Like conventional structures, damped structures generally yield during strong ground shaking, and their performance can be influenced strongly by response of higher modes.

The response spectrum and equivalent lateral force procedures presented in the standard have several simplifications and limits, as outlined below:

1. A multi-degree-of-freedom (MDOF) structure with a damping system can be transformed into equivalent single-degree-of-freedom (SDOF) systems using modal decomposition procedures. This assumes that the collapse mechanism for the structure is a single-degree-of-freedom mechanism so that the drift distribution over height can be estimated reasonably using either the first mode shape or another profile, such as an inverted triangle. Such procedures do not strictly apply to either yielding buildings or buildings that are non-proportionally damped.
2. The response of an inelastic single-degree-of-freedom system can be estimated using equivalent linear properties and a 5-percent-damped response spectrum. Spectra for damping greater than 5 percent can be established using damping

coefficients, and velocity-dependent forces can be established either by using the pseudo-velocity and modal information or by applying correction factors to the pseudo-velocity.

3. The nonlinear response of the structure can be represented by a bilinear hysteretic relationship with zero post-elastic stiffness (elasto-plastic behavior).
4. The yield strength of the structure can be estimated either by performing simple plastic analysis or by using the specified minimum seismic base shear and values of R , Ω_0 , and C_d .
5. Higher modes need to be considered in the equivalent lateral force procedure in order to capture their effects on velocity-dependent forces. This is reflected in the residual mode procedure.

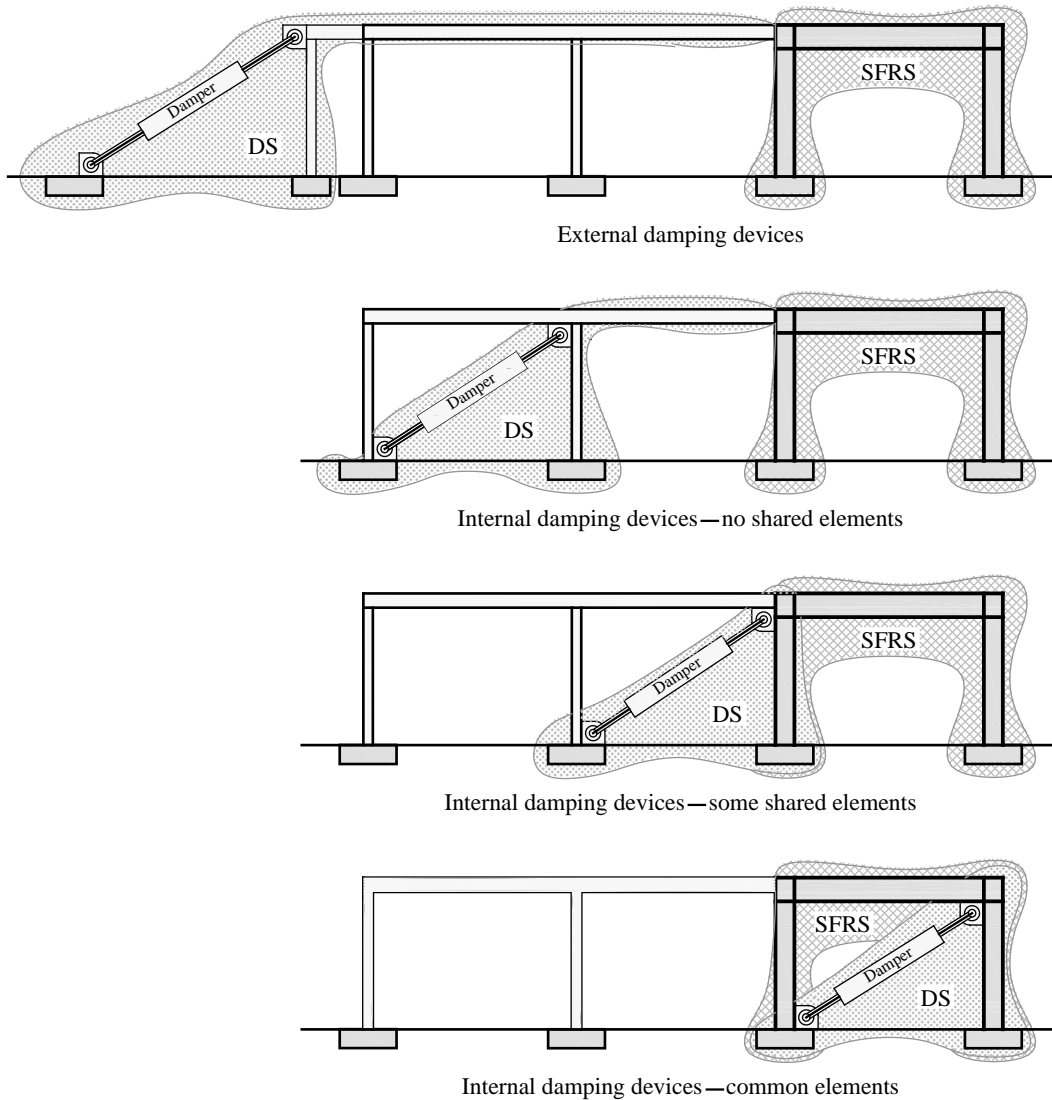

Figure C18.1-1 Damping system (DS) and seismic-force-resisting system (SFRS) configurations.

FEMA 440 (Applied Technology Council, 2005) presents a review of simplified procedures for the analysis of yielding structures. The combined effects of the simplifications mentioned above are reported by Ramirez et al. (2001) and Pavlou and Constantinou (2004) based on studies of 3-story and 6-story buildings with damping systems designed by the procedures of the standard. The response spectrum and equivalent lateral force procedures of the standard are found to provide conservative predictions of drift and predictions of damper forces and member actions that are of acceptable accuracy when compared to results of nonlinear dynamic response history analysis. When designed in accordance with the standard, structures with damping systems are expected to have structural performance at least as good as that of structures without damping systems. Pavlou and Constantinou (2006) report that structures with damping systems designed in accordance with

the standard provide the benefit of reduced secondary system response, although this benefit is restricted to systems with added viscous damping.

C18.3 NONLINEAR PROCEDURES

For designs in which the seismic-force-resisting-system is essentially elastic (assuming an overstrength of 50 percent), the only nonlinear characteristics that must be modeled in the analysis are those of the damping devices. For designs in which the seismic-force-resisting system will yield, the post-yield behavior of the structural elements must be modeled explicitly.

C18.4 RESPONSE SPECTRUM PROCEDURES and C18.5 EQUIVALENT LATERAL FORCE PROCEDURE

Effective Damping

In the standard the reduced response of a structure with a damping system is characterized by the damping coefficient, B , based on the effective damping, β , of the mode of interest. This is the same approach as that used for isolated structures. Like isolation, effective damping of the fundamental-mode of a damped structure is based on the nonlinear force-deflection properties of the structure. For use with linear analysis methods, nonlinear properties of the structure are inferred from the overstrength factor, Ω_o , and other terms.

Figure C18.4-1 illustrates reduction in design earthquake response of the fundamental mode due to increased effective damping (represented by coefficient, B_{ID}). The capacity curve is a plot of the nonlinear behavior of the fundamental mode in spectral acceleration-displacement coordinates. The reduction due to damping is applied at the effective period of the fundamental mode of vibration (based on the secant stiffness).

In general, effective damping is a combination of three components:

1. Inherent Damping (β_I)—Inherent damping of the structure at or just below yield, excluding added viscous damping (typically assumed to be 5 percent of critical for structural systems without dampers).
2. Hysteretic Damping (β_H)—Post-yield hysteretic damping of the seismic-force-resisting system and elements of the damping system at the amplitude of interest (taken as 0 percent of critical at or below yield).
3. Added Viscous Damping (β_V)—Viscous component of the damping system (taken as 0 percent for hysteretic or friction-based damping systems).

Both hysteretic damping and added viscous damping are amplitude-dependent, and the relative contributions to total effective damping change with the amount of post-yield response of the structure. For example, adding dampers to a structure decreases post-yield displacement of the structure and, hence, decreases the amount of hysteretic damping provided by the seismic-force-resisting system. If the displacements are reduced to the point of yield, the hysteretic component of effective damping is zero, and the effective damping is equal to inherent damping plus added viscous damping. If there is no damping system (as in a conventional structure), effective damping simply equals inherent damping (typically assumed to be 5 percent of critical for most conventional structures).

Linear Analysis Methods

The section specifies design earthquake displacements, velocities, and forces in terms of design earthquake spectral acceleration and modal properties. For equivalent lateral force (ELF) analysis, response is defined by two modes: the fundamental mode and the residual mode. The residual mode is a new concept used to approximate the combined effects of higher modes. While typically of secondary importance to story drift, higher modes can be a significant contributor to story velocity and, hence, are important for design of velocity-dependent damping devices. For response spectrum analysis, higher modes are explicitly evaluated.

For both the ELF and the response spectrum analysis procedures, response in the fundamental mode in the direction of interest is based on assumed nonlinear (pushover) properties of the structure. Nonlinear (pushover) properties, expressed in terms of base shear and roof displacement, are related to building capacity, expressed in terms of spectral coordinates, using mass participation and other fundamental-mode factors shown in Figure C18.4-2. The conversion concepts and factors shown in Figure C18.4-2 are the same as those defined in Chapter 9 of *Seismic Rehabilitation of Existing Buildings* (ASCE/SEI 41), which addresses seismic rehabilitation of a structure with damping devices.

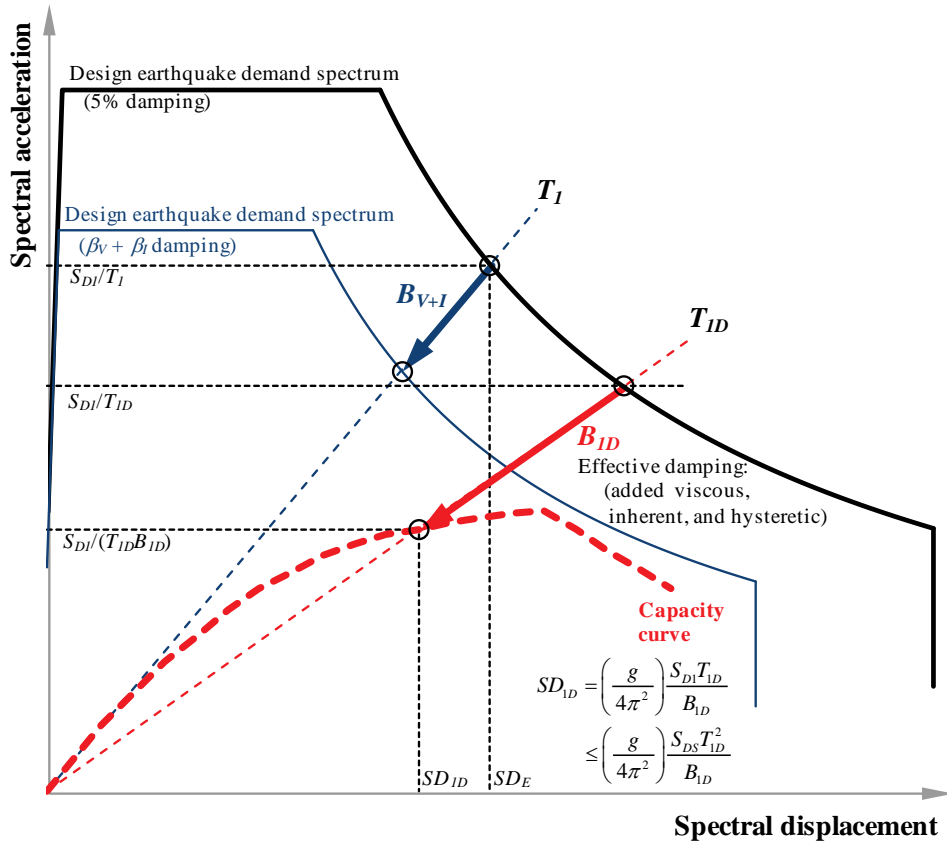

Figure C18.4-1 Effective damping reduction of design demand.

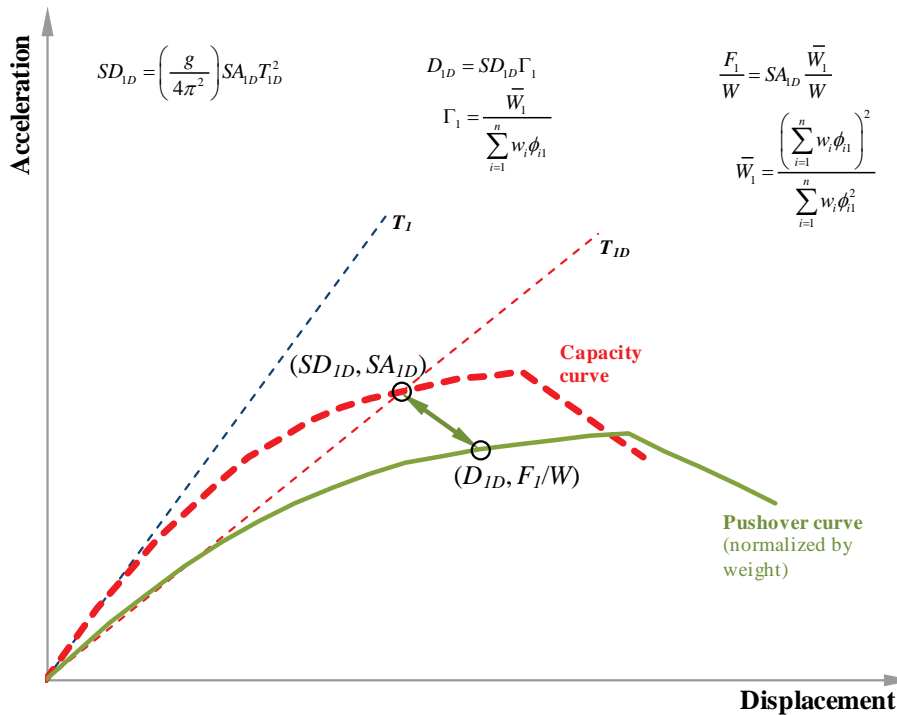

Figure C18.4-2 Pushover and capacity curves.

Where using linear analysis methods, the shape of the fundamental-mode pushover curve is not known, so an idealized elasto-plastic shape is assumed, as shown in Figure C18.4-3. The idealized pushover curve is intended to share a common point with the actual pushover curve at the design earthquake displacement, D_{1D} . The idealized curve permits definition of the global ductility demand due to the design earthquake, μ_D , as the ratio of design displacement, D_{1D} , to yield displacement, D_Y . This ductility factor is used to calculate various design factors; it must not exceed the ductility capacity of the seismic-force-resisting system, μ_{max} , which is calculated using factors for conventional structural response. Design examples using linear analysis methods have been developed and found to compare well with the results of nonlinear time history analysis (Ramirez et al., 2001).

Elements of the damping system are designed for fundamental-mode design earthquake forces corresponding to a base shear value of V_Y (except that damping devices are designed and prototypes tested for maximum considered earthquake response). Elements of the seismic-force-resisting system are designed for reduced fundamental-mode base shear, V_I , where force reduction is based on system overstrength (represented by Ω_0), multiplied by C_d/R for elastic analysis (where actual pushover strength is not known). Reduction using the ratio C_d/R is necessary because the standard provides values of C_d that are less than those for R . Where the two parameters have equal value and the structure is 5 percent damped under elastic conditions, no adjustment is necessary. Because the analysis methodology is based on calculating the actual story drifts and damping device displacements (rather than the displacements calculated for elastic conditions at the reduced base shear and then multiplied by C_d), an adjustment is needed. Since actual story drifts are calculated, the allowable story drift limits of Table 12.12-1 are multiplied by R/C_d before use.

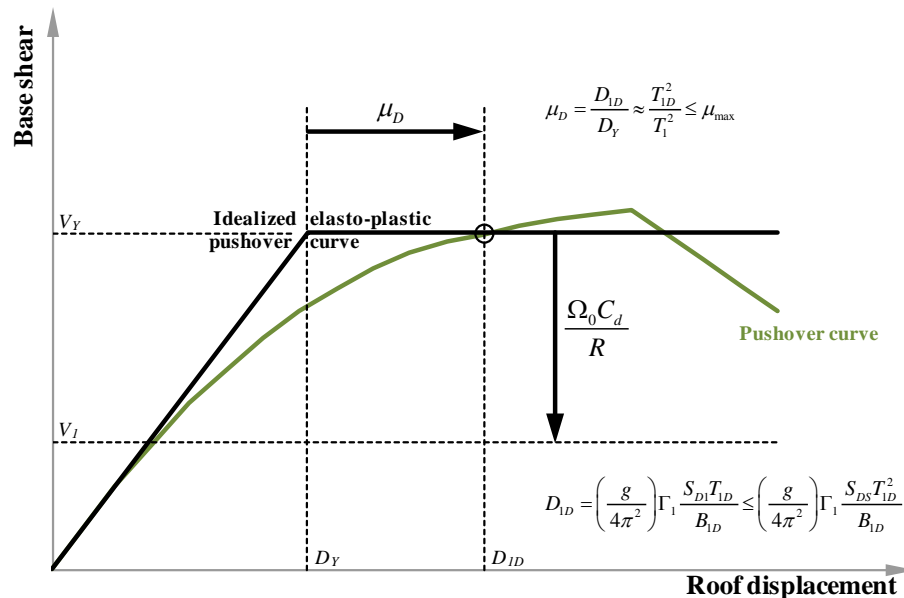

Figure C18.4-3 Idealized elasto-plastic pushover curve used for linear analysis.

C18.6 DAMPED RESPONSE MODIFICATION

C18.6.1 Damping Coefficient

Values of the damping coefficient, B , in Table 18.6-1 for design of damped structures are the same as those in Table 17.5-1 for isolated structures at damping levels up to 20 percent, but extend to higher damping levels based on results presented in Ramirez et al. (2001). Table C18.6-1 compares values of the damping coefficient as found in the standard and various resource documents and codes. FEMA 440 and the draft of Eurocode 8 present equations for the damping coefficient, B , whereas the other documents present values of B in tabular format.

The equation in FEMA 440 is

$$B = \frac{4}{5.6 - \ln(100\beta)}$$

The equation in Eurocode 8 is

$$B = \sqrt{\frac{0.05 + \beta}{0.10}}$$

Table C18.6-1 Values of Damping Coefficient, B

Effective Damping, β (%)	Table 17.5-1, 1999 AASHTO, 2001 CBC (seismically isolated structures)	Table 18.6-1 (structures with damping systems)	FEMA 440	EUROCODE 8
2	0.8	0.8	0.8	0.8
5	1.0	1.0	1.0	1.0
10	1.2	1.2	1.2	1.2
20	1.5	1.5	1.5	1.6
30	1.7	1.8	1.8	1.9
40	1.9	2.1	2.1	2.1
50	2.0	2.4	2.4	2.3

C18.6.2 Effective Damping. The effective damping is calculated assuming the structural system exhibits perfectly bi-linear hysteretic behavior characterized by the effective ductility demand, μ , as described in Ramirez et al. (2001). Effective damping is adjusted using the hysteresis loop adjustment factor, q_H , which is the actual area of the hysteresis loop divided by the area of the assumed perfectly bi-linear hysteretic loop. In general, values of this factor are less than unity. In Ramirez et al. (2001) expressions for this factor (which they call Quality Factor) are too complex to serve as a simple rule. Equation 18.6-5 provides a simple estimate of this factor. The equation predicts correctly the trend in the constant acceleration domain of the response spectrum, and it is believed to be conservative for flexible structures.

C18.7 SEISMIC LOAD CONDITIONS AND ACCEPTANCE CRITERIA

C18.7.2.5 Seismic Load Conditions and Combination of Modal Responses. Seismic design forces in elements of the damping system are calculated at three distinct stages: maximum displacement, maximum velocity, and maximum acceleration. All three stages need to be checked for structures with velocity-dependent damping systems. For displacement-dependent damping systems, the first and third stages are identical, whereas the second stage is inconsequential.

Force coefficients C_{mFD} and C_{mFV} are used to combine the effects of forces calculated at the stages of maximum displacement and maximum velocity to obtain the forces at maximum acceleration. The coefficients are presented in tabular form based on analytic expressions presented in Ramirez et al. (2001) and account for nonlinear viscous behavior and inelastic structural system behavior.

REFERENCES

- American Association of State Highway and Transportation Officials. 1999. *Guide Specifications for Seismic Isolation Design*, Washington, D.C.
- Applied Technology Council. 2005. *Improvement of Nonlinear Static Seismic Analysis Procedures*, FEMA 440. Federal Emergency Management Agency, Washington, D.C.
- California Buildings Standards Commission. 2007. *California Building Code*. Sacramento, California.
- Constantinou, M. C., T. T. Soong, and G. F. Dargush. 1998. *Passive Energy Dissipation Systems for Structural Design and Retrofit*, Monograph 1. Multidisciplinary Center for Earthquake Engineering Research, University of Buffalo, State University of New York, Buffalo.
- European Committee for Standardization. 2005. *Design of Structures for Earthquake Resistance. Part 2: Bridges*, Eurocode 8, EN1998-2, draft, August.

-
- Hanson, R. D., and T. T. Soong. 2001. *Seismic Design with Supplemental Energy Dissipation Devices*, MNO-8. Earthquake Engineering Research Institute, Oakland, California.
- Newmark, N. M., and W. J. Hall. 1969. "Seismic Design Criteria for Nuclear Reactor Facilities," in *Proceedings of the 4th World Conference in Earthquake Engineering*, Santiago, Chile.
- Pavlou, E., and M. C. Constantinou. 2004. "Response of Elastic and Inelastic Structures with Damping Systems to Near-Field and Soft-Soil Ground Motions," *Engineering Structures*, 26:1217-1230.
- Pavlou, E., and M. C. Constantinou. 2006. "Response of Nonstructural Components in Structures with Damping Systems," *ASCE Journal of Structural Engineering*, 132(7):1108-1117.
- Ramirez, O. M., M. C. Constantinou, C. A. Kircher, A. Whittaker, M. Johnson, J. D. Gomez and C. Z. Chrysostomou. 2001. *Development and Evaluation of Simplified Procedures of Analysis and Design for Structures with Passive Energy Dissipation Systems*, Technical Report MCEER-00-0010, Revision 1. Multidisciplinary Center for Earthquake Engineering Research, University of Buffalo, State University of New York, Buffalo.
- Ramirez, O. M., M. C. Constantinou, J. Gomez, A. S. Whittaker, and C. Z. Chrysostomou. 2002a. "Evaluation of Simplified Methods of Analysis of Yielding Structures With Damping Systems," *Earthquake Spectra*, 18(3):501-530.
- Ramirez, O. M., M. C. Constantinou, A. S. Whittaker, C. A. Kircher, and C. Z. Chrysostomou. 2002b. "Elastic and Inelastic Seismic Response of Buildings with Damping Systems," *Earthquake Spectra*, 18(3):531-547.
- Ramirez, O. M., M. C. Constantinou, A. S. Whittaker, C. A. Kircher, M. W. Johnson, and C. Z. Chrysostomou. 2003. "Validation of 2000 NEHRP Provisions Equivalent Lateral Force and Modal Analysis Procedures for Buildings with Damping Systems," *Earthquake Spectra*, 19(4):981-999.
- Soong, T. T., and G. F. Dargush. 1997. *Passive Energy Dissipation Systems in Structural Engineering*. J. Wiley & Sons, London, UK.
- Whittaker, A.S., M. C. Constantinou, O. M. Ramirez, M. W. Johnson, and C. Z. Chrysostomou. 2003. "Equivalent Lateral Force and Modal Analysis Procedures of the 2000 NEHRP Provisions for Buildings with Damping Systems," *Earthquake Spectra*, 19(4):959-980.

Page intentionally left blank.

COMMENTARY FOR CHAPTER 19, SOIL STRUCTURE INTERACTION FOR SEISMIC DESIGN

C19.1 GENERAL

The response of a structure to earthquake shaking is affected by interactions between three linked systems: the structure, the foundation, and the geologic media underlying and surrounding the foundation. A seismic Soil-Structure Interaction (SSI) analysis evaluates the collective response of these systems to a specified free-field ground motion. The term “free-field” refers to motions not affected by structural vibrations and represents the condition for which the design spectrum is derived using the procedures given in Chapter 11.

SSI effects are absent for the theoretical condition of rigid foundation and soil conditions. Accordingly, SSI effects reflect the differences between the actual response of the structure and the response for the theoretical, rigid base condition. Visualized within this context, three SSI effects can significantly affect the response of building structures:

1. Foundation stiffness and damping. Inertia developed in a vibrating structure gives rise to base shear, moment, and torsional excitation, and these loads in turn cause displacements and rotations of the foundation relative to the free field. These relative displacements and rotations are only possible because of compliance in the soil-foundation system, which can significantly contribute to the overall structural flexibility in some cases. Moreover, the relative foundation-free field motions give rise to energy dissipation via radiation damping (i.e., damping associated with wave propagation into the ground away from the foundation, which acts as the wave source) and hysteretic soil damping, and this energy dissipation can significantly affect the overall damping of the soil-foundation-structure system. Since these effects are rooted in the structural inertia, they are referred to as inertial interaction effects.
2. Variations between free-field and foundation-level ground motions. The differences between foundation and free-field motions result from two processes. The first is known as kinematic interaction and results from the presence of stiff foundation elements on or in soil, which cause foundation motions to deviate from free-field motion as a result of base slab averaging, wave scattering, and embedment effects. Procedures for modifying design spectra to account for these effects are given in FEMA 440 and ASCE/SEI 41. The second process is related to the structure and foundation inertia and consists of the relative foundation-free field displacements and rotations described above.
3. Foundation deformations. Flexural, axial, and shear deformations of foundation elements occur as a result of loads applied by the superstructure and the supporting soil medium. Such deformations represent the seismic demand for which foundation components should be designed. These deformations can also significantly affect the overall system behavior, especially with respect to damping.

Chapter 19 treats only the inertial interaction effects (the first item above). Inertial interaction in buildings tends to be important for stiff structural systems (such as shear walls and braced frames), particularly where the foundation soil is relatively soft (i.e., Site Classes C to E). Kinematic interaction effects are neglected in these provisions. Foundation design is covered in Section 12.13.

The procedures in Chapter 19 are used to modify the fixed-base properties (period and damping) of a structural system. If fixed-base properties are obtained from an analytical model of the structure, the fixed-base properties correspond to a condition without soil springs. If soil springs are included in the analytical model of the structure, then the procedures given in Chapter 19 should not be used to modify the building period. The damping procedures in Chapter 19 could still be used in this case if the foundation springs are linear (thus introducing no damping) and there are no dashpots in parallel with the springs. In the remainder of this commentary, it is assumed that the structural period and damping ratio that are being modified for SSI effects correspond to a fixed-base condition.

In design procedures that utilize response spectra to establish design values of base shear (i.e., force-based methods such as those given in Chapter 12), the effects of inertial SSI on the seismic response of buildings is represented as a function of the ratio of flexible- to fixed-base first-mode natural period, \tilde{T}_1/T_1 , and system damping, β_0 , attributable to foundation-soil interaction. The flexible-base first-mode damping ratio, $\tilde{\beta}$, is calculated using Equation 19-9. Figure C19-1 illustrates two possible effects of inertial SSI on the peak base shear, which is commonly computed from spectral acceleration at the first-mode. The spectral acceleration for a flexible-based structure ($\tilde{S}_a = \tilde{C}_s/g$) is obtained by entering the spectrum drawn for effective damping ratio, $\tilde{\beta}$, at the corresponding elongated period, \tilde{T} . For buildings with periods greater than about 0.5 s, using \tilde{S}_a in lieu of $S_a (=C_s/g)$ typically reduces base shear demand, whereas in very stiff structures SSI can increase the base

shear. Most equivalent lateral force methods feature a flat spectral shape at low periods that, when coupled with the requirement that $\tilde{\beta} > \beta$, results in modeling of inertial SSI that can only decrease the base shear demand.

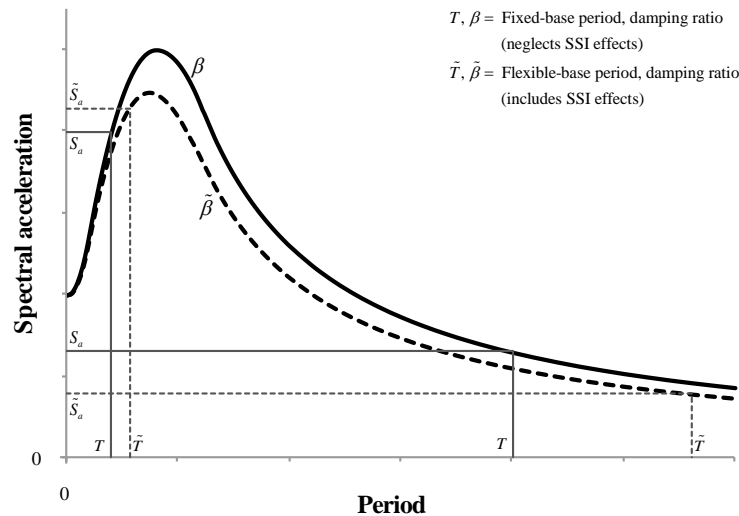

Figure C19-1 Schematic showing effects of period lengthening and foundation damping on design spectral accelerations.

The method given in Chapter 19 for evaluating inertial SSI effects is optional and has rarely been used in practice. There are several reasons for this. First, because the guidelines were written such that base shear demand can only decrease through consideration of SSI, SSI effects are ignored in order to be conservative. Second, many design engineers who have attempted to apply the method on projects have done so for major, high-rise buildings for which they felt evaluating SSI effects could provide cost savings. Unfortunately, inertial interaction effects are negligible for these tall, flexible structures, and hence the design engineers realized no benefit for their efforts and thereafter discontinued use of the procedures. The use of the procedures actually yield the most benefit for short-period ($T < 1$ sec), stiff structures with stiff, interconnected foundation systems (i.e., mats or interconnected footings) founded on soil.

C19.2 EQUIVALENT LATERAL FORCE PROCEDURE

This procedure considers the response of the structure in its fundamental mode of vibration and accounts for the contributions of the higher modes to story shears implicitly through the choice of the effective weight of the structure and the vertical distribution of the lateral forces. The effects of soil-structure interaction are accounted for on the assumption that they influence only the contribution of the fundamental mode of vibration.

C19.2.1 Base Shear. Base shear is reduced for the effects of SSI as indicated in Equation 19.2-1 and 19.2-2. As indicated in Equation 19.2-2, the change in base shear is related to the change in seismic coefficient (or spectral acceleration, as shown in Figure C19-1). The term $(0.05 \tilde{\beta})^{0.4}$ in Equation 19.2-2 represents the reduction in spectral ordinate associated with a change of damping from the fixed base value of $\beta = 0.05$ to the flexible base value of $\tilde{\beta}$.

C19.2.1.1 Effective Building Period. The fixed base period, T , is lengthened to the flexible-base period, \tilde{T} , using Equation 19.2-3, which was derived by Veletsos and Meek (1974). Terms K_y and K_θ represent the translational and rocking stiffnesses of the foundation, respectively. The standard does not provide guidance on the evaluation of these stiffness terms. Equations for K_y and K_θ are given by Gazetas (1991), and a number of practical considerations associated with the analysis of these terms are reviewed in FEMA 440 (2005). For convenience, simplified guidelines are presented below for these stiffness terms for use with the standard.

For building foundation systems having lateral continuity, such as mats or footings interconnected with grade beams, stiffnesses K_y and K_θ can often be approximated as:

$$K_y = \frac{8}{2 - \nu} Gr_a \quad (C19-2)$$

$$K_{\theta} = \frac{8}{3(1-\nu)} Gr_m^3 \alpha_{\theta} \quad (\text{C19-3})$$

where: r_a = an equivalent foundation radius that matches the area of the foundation, A_{θ} (i.e., $r_a = \sqrt{(A_{\theta}/\pi)}$); r_m = an equivalent foundation radius that matches the moment of inertia of the foundation in the direction of shaking (i.e., $r_m = \sqrt[3]{4I_{\theta}/\pi}$); G = the strain-dependent shear modulus, as defined in the standard; ν = the soil Poisson's ratio (generally taken as 0.3 for sands and 0.45 for clays); and α_{θ} = a dimensionless coefficient that depends on the period of excitation, the dimensions of the foundation, and the properties of the supporting medium (Luco, 1974; Veletsos and Verbic, 1973; Veletsos and Wei, 1971). A similar coefficient exists for translation (α_y), but can be taken as 1.0 without introducing significant error, and hence is not shown in Equation C19-2.

As noted in the standard, shear modulus G is evaluated from small-strain shear wave velocity as $G = (G/G_o)G_o = (G/G_o)\gamma v_{s0}^2/g$ (all terms defined in the standard). Shear wave velocity, v_{s0} , should be evaluated as the average small-strain shear wave velocity within the effective depth of influence below the foundation. The effective depth should be taken as $0.75r_a$ for horizontal vibrations of the foundation and $0.75r_m$ for rocking vibrations (Stewart et al., 2003). Methods for measuring v_{s0} (preferred) or estimating it from other soil properties are summarized elsewhere (e.g., Kramer, 1996).

The dynamic modifier for rocking, α_{θ} , can significantly affect the computed response of some building structures. In the absence of more detailed analyses, for ordinary building structures with an embedment ratio $d/r_m < 0.5$ (where d = depth of embedment, measured from ground surface to base of foundation), the factor α_{θ} can be estimated as follows (Stewart et al., 2003):

$r_m/(v_{s0}T)$	α_{θ}
< 0.05	1.0
0.15	0.85
0.35	0.7
0.5	0.6

Foundation embedment has the effect of increasing the stiffnesses K_y and K_{θ} . For embedded foundations for which there is positive contact between the side walls and the surrounding soil, K_y and K_{θ} may be determined from the following approximate formulas (Kausel, 1974):

$$K_y = \frac{8Gr_a}{2-\nu} \left[1 + \left(\frac{2}{3} \right) \left(\frac{d}{r_a} \right) \right] \quad (\text{C19-4})$$

$$K_{\theta} = \frac{8Gr_m^3}{3(1-\nu)} \left[1 + 2 \left(\frac{d}{r_m} \right) \right] \quad (\text{C19-5})$$

Experimental studies and field performance data (Stokoe and Erden, 1975; Stewart et al., 1999) indicate that the effects of foundation embedment are sensitive to the condition of the backfill and that judgment must be exercised in using Equations C19-4 and C19-5. For example, if contact is lost between the soil and basement walls, stiffnesses K_y and K_{θ} should be determined from the formulas for surface-supported foundations. More generally, the quantity d above should be interpreted as the effective depth of foundation embedment for the conditions that would prevail during the design earthquake ground motion.

The formulas for K_y and K_{θ} presented above can be applied to most soil profiles in which soil shear wave velocity, v_{s0} , changes with depth. However, if the soil profile consists of a surface stratum of soil underlain by a much stiffer deposit with a shear wave velocity more than twice that of the surface layer, K_y and K_{θ} may be determined from the following two generalized formulas in which G is the shear modulus of the surface soil and D_s is the total depth of the stratum:

$$K_y = \frac{8Gr_a}{2-\nu} \left[1 + \left(\frac{2}{3} \right) \left(\frac{d}{r_a} \right) \right] \left[1 + \left(\frac{1}{2} \right) \left(\frac{r_a}{D_s} \right) \right] \left[1 + \left(\frac{5}{4} \right) \left(\frac{d}{D_s} \right) \right] \quad (\text{C19-6})$$

$$K_{\theta} = \frac{8Gr_m^3}{3(1-\nu)} \left[1 + 2 \left(\frac{d}{r_m} \right) \right] \left[1 + \left(\frac{1}{6} \right) \left(\frac{r_m}{D_s} \right) \right] \left[1 + 0.7 \left(\frac{d}{D_s} \right) \right] \quad (\text{C19-7})$$

The above formulas are based on analyses of a stratum supported on a rigid base (Elsabee et al., 1977; Kausel and Roesset, 1975) and apply for $r/D_s < 0.5$ and $d/r < 1$ (r taken as either r_a or r_m). The applicability of those rigid base solutions to practical situations (non-rigid geologic media) was evaluated by Stewart et al. (2003), resulting in the recommendations provided above.

For buildings supported on footing foundations, the above formulas can generally be used with r_a and r_m calculated using the full building footprint dimensions, provided that the footings are interconnected with grade beams. An exception can occur for buildings with both shear walls and frames, for which the rotation of the foundation beneath the wall may be independent of that for the foundation beneath the column (this is referred to as weak rotational coupling). In such cases, r_m is often best calculated using the dimensions of the wall footing. Very stiff foundations, which provide strong rotational coupling, are best described using an r_m value that reflects the full foundation dimension. Regardless of the degree of rotational coupling, r_a should be calculated using the full foundation dimension if foundation elements are interconnected or continuous. Further discussion can be found in FEMA (2005). The use of discrete (non-interconnected) spread footing foundations in seismic regions is not recommended.

For buildings supported on pile foundations, lateral stiffness, K_y , can be taken as the sum of the lateral head stiffnesses of the supporting piles. These stiffness values are generally calculated using a beam on Winkler foundation model, which is discussed in detail elsewhere (e.g., Salgado, 2006). Rotational stiffness, K_θ , can be calculated from the vertical stiffness of the individual piles, k_{zi} , as follows:

$$K_\theta \approx \sum_i k_{zi} y_i^2 \quad (\text{C19-8})$$

where y_i = horizontal distance from the foundation centroidal axis to pile i measured in the direction of shaking. The approximation in Equation C19-8 assumes an infinitely rigid pile cap and neglects the rotational stiffness of individual piles, which is typically a small contribution. Quantity k_{zi} can be calculated for an individual pile using well-established methods, such as discrete element modeling with t - z curves (e.g., Salgado, 2006).

The alternate approach in the standard, represented by Equation 19.2-5, was derived using Poisson's ratio $\nu = 0.4$, and is generally sufficient for non-embedded foundations that are laterally continuous across the building footprint and for which there is no "rigid" layer at depth in the profile (which would require the use of Equations C19-6 and C19-7 to calculate foundation stiffness). The value of relative weight parameter, α (defined in the standard), can be taken as approximately 0.15 for typical buildings.

C19.2.1.2 Effective Damping. Bielak (1975, 1976) and Veletsos and Nair (1975) expressed the flexible-base first-mode damping ratio, $\tilde{\beta}$, as indicated in Equation 19.2-9. This equation is based on analyses of the harmonic response of single-degree-of-freedom oscillators supported on a visco-elastic medium with hysteretic damping. Foundation damping factor β_0 incorporates the effects of energy dissipation into the soil due to radiation damping and hysteretic damping in the soil.

Figure 19.2-1 shows β_0 as a function of period lengthening ratio and was derived from the analytical solution presented in Veletsos and Nair (1975) for the condition of zero foundation embedment. Additional damping can be realized for embedded foundations, and the use of damping values from Figure 19.2-1 is conservative for such conditions. More exact solutions can be obtained using procedures given in FEMA (2005).

Equation 19.2-9, in combination with the information presented in Figure 19.2-1, may lead to damping factors for the soil-foundation-structure system, $\tilde{\beta}$, that are smaller than the fixed base structural damping, β (assumed to be 0.05). However, it is recommended that $\tilde{\beta}$ never be taken as less than 0.05 for design applications. The use of values of $\tilde{\beta} > \beta$ is well-justified from field case-history data (Stewart et al., 1999, 2003).

The presence of a stiff layer at depth in the soil profile can impede radiation damping, rendering the values in Figure 19.2-1 too high. If a site consists of a relatively uniform layer of depth, D_s , overlying a very stiff layer with a shear wave velocity more than twice that of the surface layer, damping values should be reduced as indicated by Equation 19.2-12.

C19.2.2 Vertical Distribution of Seismic Forces. The vertical distributions of the equivalent lateral forces for flexibly and rigidly supported structures are similar, and it is recommended that the same distribution be used in both cases, changing only the magnitude of the forces to correspond to the appropriate base shear. A greater degree of refinement in this step would be inconsistent with the approximations embodied in the requirements for rigidly supported structures.

With the vertical distribution of the lateral forces established, the overturning moments and the torsional effects about a vertical axis are computed as for rigidly supported structures. The above procedure is applicable to planar structures and, with some extension, to three-dimensional structures.

C19.2.3 Other Effects. In addition to its effect on base shear, inertial SSI also can increase the horizontal displacements of the structure relative to its base (because of rocking). This can increase the required spacing between structures and secondary design forces associated with P -delta effects. Such effects can be significant for stiff structural systems (e.g., walls and braced frames).

C19.3 MODAL ANALYSIS PROCEDURE

The procedure outlined above in Section C19.2 is applicable to a modal analysis by adjusting the modal period and damping ratio of the fundamental mode only. Higher modes are relatively unaffected by SSI (e.g., Bielak, 1976; Chopra and Gutierrez, 1974; Veletsos, 1977). Hence, the contributions of higher modes are computed as if the structure were fixed at the base, and the maximum value of a response quantity is determined as for fixed-base structures but with the adjusted first-mode responses.

REFERENCES

- American Society of Civil Engineers/Structural Engineering Institute. 2006. *Seismic Rehabilitation of Existing Buildings*, ASCE/SEI 41. ASCE/SEI, Reston, Virginia.
- Bielak, J. 1975. "Dynamic Behavior of Structures with Embedded Foundations," *Earthquake Engineering and Structural Dynamics*, 3:259-274.
- Bielak, J. 1976. "Modal Analysis for Building-Soil Interaction," *Journal of the ASCE Engineering Mechanics Division* 102(EM5):771-786.
- Chopra, A. K., and J. A. Gutierrez. 1974. "Earthquake Analysis of Multistory Buildings Including Foundation Interaction," *Journal of Earthquake Engineering and Structural Dynamics*, 3:65-67.
- Elsabee, F., I. Kausel, and J. M. Roesset. 1977. "Dynamic Stiffness of Embedded Foundations," in *Proceedings of the ASCE Second Annual Engineering Mechanics Division Specialty Conference*, pp. 40-43.
- Federal Emergency Management Agency. 2005. *Improvement of Nonlinear Static Seismic Analysis Procedures*, FEMA 440. Federal Emergency Management Agency, Washington, D.C.
- Gazetas, G. 1991. "Formulas and Charts for Impedances of Surface and Embedded Foundations," *Journal of Geotechnical Engineering*, 117(9):1363-1381.
- Kausel, E. 1974. *Force Vibrations of Circular Foundations on Layered Media*, Report R74-11. Department of Civil Engineering, Massachusetts Institute of Technology, Cambridge.
- Kausel, E., and J. M. Roesset. 1975. "Dynamic Stiffness of Circular Foundations," *Journal of the Engineering Mechanics Division* 101(EM6):771-785.
- Kramer, S.L. 1996. *Geotechnical Earthquake Engineering*. Prentice Hall, Upper Saddle River, New Jersey.
- Luco, J. E. 1974. "Impedance Functions for a Rigid Foundation on a Layered Medium," *Nuclear Engineering and Design*, (31):204-217.
- Salgado, R. 2006. *The Engineering of Foundations*. McGraw-Hill.
- Stewart, J. P., R. B. Seed, and G. L. Fenves. 1999. "Seismic Soil-Structure Interaction in Buildings. II: Empirical Findings," *ASCE Journal of Geotechnical & Geoenvironmental Engineering*, 125(1):38-48.
- Stewart, J. P., S. Kim, J. Bielak, R. Dobry, and M. Power. 2003. "Revisions to Soil Structure Interaction Procedures in NEHRP Design Provisions," *Earthquake Spectra*, 19(3):677-696.
- Stokoe, II, K. H., and S. M. Erden. 1975. "Torsional Response of Embedded Circular Foundations," in *Proceedings of the 5th European Conference on Earthquake Engineering*.
- Veletsos, A. S., and V. V. Nair. 1975. "Seismic Interaction of Structures on Hysteretic Foundations," *Journal of the ASCE Structural Division*, 101(ST1):109-129.
- Veletsos, A. S. 1977. "Dynamics of Structure-Foundation Systems," in *Structural and Geotechnical Mechanics, A Volume Honoring N. M. Newmark*, edited by W. J. Hall, pp. 333-361. Prentice-Hall, Englewood Cliffs, New Jersey.
- Veletsos, A. S., and J. W. Meek. 1974. "Dynamic Behavior of building Foundation Systems," *Earthquake Engineering and Structural Dynamics*, 3(2):121-138.

Veletsos, A. S., and B. Verbic. 1973. "Vibration of Viscoelastic Foundations," *Earthquake Engineering and Structural Dynamics*, 2(1):87-105.

Veletsos, A. S., and Y. T. Wei. 1971. "Lateral and Rocking Vibration of Footings," *Journal of the ASCE Soil Mechanics and Foundations Division*, 97(SM9):1227-1248.

COMMENTARY FOR CHAPTER 20, SITE CLASSIFICATION PROCEDURE FOR SEISMIC DESIGN

C20.1 SITE CLASSIFICATION

Site classification procedures are given in Chapter 20 for the purpose of classifying the site and determining site coefficients and site-adjusted maximum considered earthquake ground motions in accordance with Section 11.4.3. Site classification procedures are also used to define the site conditions for which site-specific site response analyses are required to obtain site ground motions in accordance with Section 11.4.7 and Chapter 21.

C20.3 SITE CLASS DEFINITIONS

C20.3.1 Site Class F. Site conditions for which the site coefficients F_a and F_v in Tables 11.4-1 and 11.4-2 may not be applicable and for which site-response analyses are required by Section 11.4.7. For short-period structures it is permissible to determine values of F_a and F_v assuming that liquefaction does not occur, because ground motion data obtained in liquefied soil areas during earthquakes indicate that short-period ground motions generally are attenuated due to liquefaction whereas long-period ground motions may be amplified. This exception does not affect the requirements in Section 11.8 to assess liquefaction potential as a geologic hazard and to develop hazard mitigation measures as required.

C20.3.2 through C20.3.5. These sections and Table 20.3-1 provide definitions for Site Classes A through E. Except for the additional definitions for Site Class E in Section 20.3.2, the site classes are defined fundamentally in terms of the average small-strain shear wave velocity in the top 100 feet (30 meters) of the soil or rock profile. If shear wave velocities are available for the site, they should be used to classify the site. However, recognizing that in many cases shear wave velocities are not available for the site, alternative definitions of the site classes also are included. These definitions are based on geotechnical parameters: standard penetration resistance for cohesionless soils and rock, and standard penetration resistance and undrained shear strength for cohesive soils. The alternative definitions are intended to be conservative since the correlation between site coefficients and these geotechnical parameters is more uncertain than the correlation with shear wave velocity. That is, values of F_a and F_v will tend to be smaller if the site class is based on shear wave velocity rather than on the geotechnical parameters. Also, the site class definitions should not be interpreted as implying any specific numerical correlation between shear-wave velocity and standard penetration resistance or undrained shear strength.

Although the site class definitions in Sections 20.3.2 through 20.3.5 are straightforward, there are aspects of these assessments that may require additional judgment and interpretation. Highly variable subsurface conditions beneath a building footprint could result in overly conservative or unconservative site classification. Isolated soft soil layers within an otherwise firm soil site may not affect the overall site response if the predominant soil conditions do not include such strata. Conversely, site response studies have shown that continuous, thin, soft clay strata may affect the site amplification.

The site class should reflect the soil conditions that will affect the ground motion input to the structure or a significant portion of the structure. For structures receiving substantial ground motion input from shallow soils (for example, structures with shallow spread footings, with laterally flexible piles, or with basements where substantial ground motion input to the structure may come through the side walls), it is reasonable to classify the site on the basis of the top 100 feet (30 meters) of soils below the ground surface. Conversely, for structures with basements supported on firm soils or rock below soft soils, it may be reasonable to classify the site on the basis of the soils or rock below the mat, if it can be justified that the soft soils contribute very little to the response of the structure.

Buildings on sites with sloping bedrock or having highly variable soil deposits across the building area require careful study since the input motion may vary across the building (for example, if a portion of the building is on rock and the rest is over weak soils). Site-specific studies including two- or three-dimensional modeling may be used in such cases to evaluate the subsurface conditions and site and superstructure response. Other conditions that may warrant site-specific evaluation include the presence of low shear wave velocity soils below a depth of 100 feet (30 meters), location of the site in a sedimentary basin, or subsurface or topographic conditions with strong two- and three-dimensional site-response effects. Individuals with appropriate expertise in seismic ground motions should participate in evaluations of the need for and nature of such site-specific studies.

C20.4 DEFINITION OF SITE CLASS PARAMETERS

Section 20.4 provides formulas for defining Site Classes in accordance with definitions in Section 20.3 and Table 20.3-1. Equation 20.4-1 is for determining the effective average small-strain shear-wave velocity, \bar{v}_s , to a depth of 100 feet (30

meters) at a site. This equation defines \overline{v}_s as 100 feet (30 meters) divided by the sum of the times for a shear wave to travel through each layer within the upper 100 feet (30 meters), where travel time for each layer is calculated as the layer thickness divided by the small-strain shear wave velocity for the layer. It is important that this method of averaging be used as it may result in a significantly lower effective average shear wave velocity than the velocity that would be obtained by directly averaging the velocities of the individual layers.

For example, consider a soil profile having four 25-foot-thick layers with shear wave velocities of 500, 1,000, 1,500, and 2,000 ft/s. The arithmetic average of the shear wave velocities is 1250 ft/s (corresponding to Site Class C), but Equation 20.4-1 produces a value of 960 ft/s (corresponding to Site Class D). The Equation 20.4-1 value is appropriate as the four layers are being represented by one layer with the same wave passage time.

Equation 20.4-2 is for classifying the site using the average standard penetration resistance blow count, \overline{N} , for cohesionless soils, cohesive soils, and rock in the upper 100 feet (30 meters). A method of averaging analogous to the method of Equation 20.4-1 for shear wave velocity is used. The maximum value of N that may be used for any depth of measurement in soil or rock is 100 blows/foot. For the common situation where rock is encountered, the standard penetration resistance, N , for rock layers is taken as 100.

Equations 20.4-3 and 20.4-4 are for classifying the site using the standard penetration resistance of cohesionless soil layers, N_{ch} , and the undrained shear strength of cohesive soil layers, s_u , within the top 100 feet (30 meters). These equations are provided as an alternative to using Equation 20.4-2 for which N -values in all geologic materials in the top 100 feet (30 meters) are used. Where using Equations 20.4-3 and 20.4-4, only the respective thicknesses of cohesionless soils and cohesive soils within the top 100 feet (30 meters) are used.

COMMENTARY FOR CHAPTER 21, SITE-SPECIFIC GROUND MOTION PROCEDURES FOR SEISMIC DESIGN

GENERAL

Site-specific procedures for computing earthquake ground motions include dynamic site response analyses and probabilistic and deterministic seismic hazard analyses (PSHA and DSHA), which may include dynamic site response analysis as part of the calculation. Use of site-specific procedures may be required in lieu of the general procedure in Sections 11.4.1 through 11.4.6; Section C11.4.7 explains the conditions under which the use of these procedures is required. Such studies must be comprehensive and incorporate current scientific interpretations. Because there is typically more than one scientifically credible alternative for models and parameter values used to characterize seismic sources and ground motions, it is important to formally incorporate these uncertainties in a site-specific analysis. For example, uncertainties may exist in seismic source location, extent and geometry; maximum earthquake magnitude; earthquake recurrence rate; ground-motion attenuation; local site conditions, including soil layering and dynamic soil properties; and possible two- or three-dimensional wave-propagation effects. The use of peer review for a site-specific ground-motion analysis is encouraged.

Site-specific ground-motion analysis can consist of one of the following approaches: (a) PSHA and possibly DSHA if the site is near an active fault, (b) PSHA/DSHA followed by dynamic site-response analysis, and (c) dynamic site response analysis only. The first approach is used to compute ground motions for bedrock or stiff soil conditions (not softer than Site Class D). In this approach, if the site consists of stiff soil overlying bedrock, for example, the analyst has the option of either (a) computing the bedrock motion from the PSHA/DSHA and then using the site-coefficient (F_a and F_v) tables in Section 11.4.3 to adjust for the stiff soil overburden or (b) computing the response spectrum at the ground surface directly from the PSHA/DSHA. The latter requires the use of attenuation equations for computing stiff soil-site response spectra (instead of bedrock response spectra).

The second approach is used where softer soils overlie the bedrock or stiff soils. The third approach assumes that a site-specific PSHA/DSHA is not necessary, but that a dynamic site response analysis should or must be performed. This analysis requires the definition of an outcrop ground motion, which can be based on the 5 percent damped response spectrum computed from the PSHA/DSHA or obtained from the general procedure in Section 11.4. A representative set of acceleration time histories are selected and scaled to be compatible with this outcrop spectrum. Dynamic site response analyses using these acceleration histories as input are used to compute motions at the ground surface. The response spectra of these surface motions are used to define a maximum considered earthquake (MCE) ground motion response spectrum.

The approaches described above have advantages and disadvantages. In many cases, user preference governs the selection, but geotechnical conditions at the site may dictate the use of one approach over the other. On the one hand, if bedrock is at a depth much greater than the extent of the site geotechnical investigations, the direct approach of computing the ground-surface motion in the PSHA/DSHA may be more reasonable. On the other hand, if bedrock is shallow and a large impedance contrast exists between it and the overlying soil (i.e., density times shear-wave velocity of bedrock is much greater than that of the soil), the two-step approach might be more appropriate.

Use of peak ground acceleration as the anchor for a generalized site-dependent response spectrum is discouraged because sufficiently robust ground-motion attenuation relations are available for computing response spectra in western United States and eastern United States tectonic environments.

C21.1 SITE RESPONSE ANALYSIS

C21.1.1 Base Ground Motions. Ground motion acceleration histories that are representative of horizontal rock motions at the site are required as input to the soil model. Where a site-specific ground motion hazard analysis is not performed, the MCE response spectrum for Site Class B (rock) is defined using the general procedure described in Section 11.4.1. If the model is terminated in material of Site Class A, C, or D, the input MCE response spectrum is adjusted in accordance with Section 11.4.3. The United States Geological Survey national seismic hazard mapping project website (<http://earthquake.cr.usgs.gov/research/hazmaps/>) includes hazard deaggregation options that can be used to evaluate the predominant types of earthquake sources, magnitudes, and distances contributing to the probabilistic ground-motion hazard. Sources of recorded acceleration time histories include the databases of the Consortium of Organizations for Strong Motion Observation Systems (COSMOS) Virtual Data Center website (db.cosmos-eq.org) and the Pacific Earthquake Engineering Research Center (PEER) Strong Motion Data Base website (http://peer.berkeley.edu/products/strong_ground_motion_db.html/), and the United States National Center for Engineering

Strong Motion Data (NCESMD) website (<http://www.strongmotioncenter.org>). Ground motion acceleration histories at these sites generally were recorded at the ground surface and hence apply for an outcropping condition and should be specified as such in the input to the site response analysis code (see Kwok et al., 2007, for additional details).

C21.1.2 Site Condition Modeling. Modeling criteria are established by site-specific geotechnical investigations that should include: (a) borings with sampling, (b) standard penetration tests (SPTs), cone penetrometer tests (CPTs), and/or other subsurface investigative techniques, and (c) laboratory testing to establish the soil types, properties, and layering. The depth to rock or stiff soil material should be established from these investigations. Investigation should extend to bedrock or, for very deep soil profiles, to material in which the model will be terminated. While it is preferable to measure shear wave velocities in all soil layers, it is also possible to estimate shear wave velocities based on measurements available for similar soils in the local area or through correlations with soil types and properties. A number of such correlations are summarized by Kramer (1996).

Typically, a one-dimensional soil column extending from the ground surface to bedrock is adequate to capture first-order site response characteristics. For very deep soils, the model of the soil columns may extend to very stiff or very dense soils at depth in the column. Two- or three-dimensional models should be considered for critical projects when two- or three-dimensional wave propagation effects may be significant (for example, sloping ground sites). The soil layers in a one-dimensional model are characterized by their total unit weights and shear wave velocities from which low-strain (maximum) shear moduli may be obtained, and by relationships defining the nonlinear shear stress-strain behavior of the soils. The required relationships for analysis are often in the form of curves that describe the variation of soil shear modulus with shear strain (modulus reduction curves) and by curves that describe the variation of soil damping with shear strain (damping curves). In a two- or three-dimensional model, compression wave velocities or moduli or Poisson ratios also are required. In an analysis to estimate the effects of liquefaction on soil site response, the nonlinear soil model also must incorporate the buildup of soil pore water pressures and the consequent reductions of soil stiffness and strength. Typically, modulus reduction curves and damping curves are selected on the basis of published relationships for similar soils (for example, Vucetic and Dobry, 1991; Electric Power Research Institute, 1993; Darendeli, 2001; Menq, 2003; Zhang et al., 2005). Site-specific laboratory dynamic tests on soil samples to establish nonlinear soil characteristics can be considered where published relationships are judged to be inadequate for the types of soils present at the site. Shear and compression wave velocities and associated maximum moduli should be selected based on field tests to determine these parameters or, if such tests are not possible, on published relationships and experience for similar soils in the local area. The uncertainty in the selected maximum shear moduli, modulus reduction and damping curves, and other soil properties should be estimated (see Darendeli, 2001; and Zhang et al., 2008). Consideration of the range of stiffnesses prescribed in Section 12.13.3 (increasing and decreasing by 50 percent) is recommended.

C21.1.3 Site Response Analysis and Computed Results. Analytical methods may be equivalent linear or nonlinear. Frequently used computer programs for one-dimensional analysis include the equivalent linear program SHAKE (Schnabel et al., 1972; Idriss and Sun, 1992) and the nonlinear programs FLAC (Itasca, 2005), DESRA-2 (Lee and Finn, 1978), MARDES (Chang et al., 1991), SUMDES (Li et al., 1992), DMOD_2 (Matasovic, 2006), DEEPSOIL (Hashash and Park, 2001), TESS (Pyke, 2000), and OpenSees (Ragheb, 1994; Parra, 1996; Yang, 2000). If the soil response induces large strains in the soil (such as for high acceleration levels and soft soils), nonlinear programs may be preferable to equivalent linear programs. For analysis of liquefaction effects on site response, computer programs incorporating pore water pressure development (effective stress analyses) should be used (for example, FLAC, DESRA-2, SUMDES, D-MOD, TESS, DEEPSOIL, and OpenSees). Response spectra of output motions at the ground surface are calculated as the ratios of response spectra of ground-surface motions to input outcropping rock motions. Typically, an average of the response spectral ratio curves is obtained and multiplied by the input MCE response spectrum to obtain the MCE ground-surface response spectrum. Alternatively, the results of site-response analyses can be used as part of the PSHA using procedures described by Goulet et al. (2007) and programmed for use in OpenSHA (www.opensha.org; Field et al., 2005). Sensitivity analyses to evaluate effects of soil-property uncertainties should be conducted and considered in developing the final MCE response spectrum.

C21.2 GROUND MOTION HAZARD ANALYSIS

Uncertainties in the characterizations of the key seismic sources (tectonic provinces, zones of seismicity, and active faults), with respect to location, earthquake recurrence, and maximum earthquake magnitude, must be considered in the ground motion hazard analysis. Uncertainties in the ground-motion models are typically included by incorporating more than one ground-motion attenuation equation. However, these equations may underestimate the intermediate- and long-period motion from large earthquakes on nearby active faults due to directivity and directionality effects mentioned in C11.4.7. The probabilistic seismic hazard analysis code can be modified to account for these effects in a consistent probabilistic manner, or a deterministic adjustment can be made to the probabilistic MCE response spectrum using methods in Somerville et al. (1997) and Abrahamson (2000) or more recent procedures. If the deterministic adjustment is used, then judgment must be

exercised in selecting the parameters comprising these methods. The worst-case scenario yielding the maximum possible increase in motion from directivity/directionality effects is acknowledged to be conservative, but it offers an upper-bound solution to help gauge the appropriate level for the MCE response spectrum.

Site-response effects in PSHA generally should be evaluated by using the site term in the ground-motion prediction equations. This term is generally a scale factor or a function of V_{s30} = average shear-wave velocity in the upper 30 meters. Site-specific dynamic response analyses can also be performed as described in Section C21.1.

C21.2.1 Probabilistic MCE. PSHA methods are sufficient to define the MCE ground motion at all locations except those near highly active faults. Descriptions of current PSHA methods can be found in McGuire (2004).

C21.2.2 Deterministic MCE. Ground motions for the deterministic MCE shall be based on characteristic earthquakes on all known active faults in a region. The magnitude of a characteristic earthquake on a given fault should be a best estimate of the maximum magnitude capable for that fault but not less than the largest magnitude that has occurred historically on the fault. The maximum magnitude should be estimated considering all seismic-geologic evidence for the fault, including fault length and paleoseismic observations. For faults characterized as having more than a single segment, the potential for rupture of multiple segments in a single earthquake should be considered in assessing the characteristic maximum magnitude for the fault.

For consistency, the same attenuation equations used in the PSHA should be used in the DSHA. Adjustments for directivity/directional effects should also be made, when appropriate. In some cases, ground-motion simulation methods may be appropriate for the estimation of long-period motions at sites in deep sedimentary basins or from great ($M \geq 8$) or giant ($M \geq 9$) earthquakes, for which recorded ground-motion data are lacking.

As a point of clarification, the deterministic lower limit spectrum on the MCE (Figure 21.2-1) extends to zero period in the same manner as the design response spectrum of Figure 11.4-1. The spectrum in Figure 21.2-1 is simply a schematic illustrating the lower bounds for the constant spectral acceleration ($S_{aM} = 1.5F_a$) and constant spectral velocity ($S_{vM} = 0.6F_v/T$) portions of the spectrum. The transition in the deterministic lower limit spectrum from the $1.5F_a$ plateau to zero period occurs at a period (in seconds) of $0.08F_v/F_a$ which is derived in the same manner as T_0 in Section 11.4.5. From this period to zero period, where the ordinate is $0.6F_a$, the deterministic lower limit spectrum is a straight line, similar to the design response spectrum in the period band, 0 to T_0 .

C21.3 DESIGN RESPONSE SPECTRUM

Eighty percent of the design response spectrum determined in accordance with Section 11.4.5 was established as the lower limit to prevent the possibility of site-specific studies generating unreasonably low ground motions from potential misapplication of site-specific procedures or misinterpretation or mistakes in the quantification of the basic inputs to these procedures. Even if site-specific studies were correctly performed and resulted in ground-motion response spectra less than the 80 percent lower limit, the uncertainty in the seismic potential and ground-motion attenuation across the United States was recognized in setting this limit. Under these circumstances, the allowance of up to a 20 percent reduction in the design response spectrum based on site-specific studies was considered reasonable.

C21.4 DESIGN ACCELERATION PARAMETERS

The 90 percent lower limit rule, which can affect the determination of S_{DS} , was inserted because it was recognized that site-specific studies could produce response spectra with ordinates at periods greater than 0.2 second that were significantly greater than those at 0.2 second. Similarly, the rule that requires that S_{D1} be taken as the larger of the spectral acceleration at a period of 1 second and two times the spectral acceleration at a period of 2 seconds accounts for the possibility that the assumed $1/T$ proportionality for the constant velocity portion of the design response spectrum begins at periods greater than 1 second or is actually $1/T^n$ (where $n < 1$). Thus, this rule leads to more accurate spectral ordinates at periods around 2 seconds and conservative estimates at shorter periods. However, the conservatism is unlikely to be excessive.

REFERENCES

- Abrahamson, N. A. 2000. "Effects of Rupture Directivity on Probabilistic Seismic Hazard Analysis," in *Proceedings of the Sixth International Conference on Seismic Zonation*, Palm Springs, California.
- Chang, C.-Y., C. M. Mok, M. S. Power, and Y. K. Tang. 1991. *Analysis of Ground Response at Lotung Large-Scale Soil-Structure Interaction Experiment Site*, Report NP-7306-SL. Electric Power Research Institute, Palo Alto, California.

- Darendeli, M. 2001. Development of a New Family of Normalized Modulus Reduction and Material Damping Curves," Ph.D. Dissertation, Department of Civil Engineering, University of Texas, Austin.
- Electric Power Research Institute. 1993. *Guidelines for Determining Design Basis Ground Motions*, Report EPRI TR-102293. EPRI, Palo Alto, California.
- Field, E. H., N. Gupta, V. Gupta, M. Blanpied, P. Maechling, and T. H. Jordan. 2005. "Hazard Calculations for the WGCEP-2002 Forecast Using OpenSHA and Distributed Object Technologies," *Seism. Res. Letters*, 76:161-167.
- Goulet, C. A., J. P. Stewart, P. Bazzurro, and E. H. Field. 2007. "Integration of Site-Specific Ground Response Analysis Results into Probabilistic Seismic Hazard Analyses," Paper 1486 in *Proceedings of the 4th International Conference on Earthquake Geotechnical Engineering*, Thessaloniki, Greece.
- Hashash, Y. M. A. and D. Park. 2001. "Non-Linear One-Dimensional Seismic Ground Motion Propagation in the Mississippi Embayment," *Engineering Geology*, 62(1-3):185-206.
- Idriss, I. M., and J. I. Sun. 1992. *User's Manual for SHAKE91*. Center for Geotechnical Modeling, Department of Civil and Environmental Engineering, University of California, Davis.
- Itasca Consulting Group. 2005. *FLAC, Fast Lagrangian Analysis of Continua*, Version 5.0. Itasca Consulting Group, Minneapolis, Minnesota.
- Kramer, S. L. 1996. *Geotechnical Earthquake Engineering*. Prentice Hall.
- Kwok, A. O., J. P. Stewart, Y. M. A. Hashash, N. Matasovic, R. Pyke, Z. Wang, and Z. Yang. 2007. "Use of Exact Solutions of Wave Propagation Problems to Guide Implementation of Nonlinear Seismic Ground Response Analysis Procedures," *ASCE Journal of Geotechnical & Geoenvironmental Engineering*, 133(11):1385-1398.
- Lee, M. K. W., and W. D. L. Finn. 1978. *DESRA-2, Dynamic Effective Stress Response Analysis of Soil Deposits with Energy Transmitting Boundary Including Assessment of Liquefaction Potential*, Soil Mechanics Series 36. Department of Civil Engineering, University of British Columbia, Vancouver, Canada.
- Li, X. S., Z. L. Wang, and C. K. Shen. 1992. *SUMDES, A Nonlinear Procedure for Response Analysis of Horizontally-Layered Sites Subjected to Multi-Directional Earthquake Loading*. Department of Civil Engineering, University of California, Davis.
- Matasovic, N. 2006. "D-MOD_2 – A Computer Program for Seismic Response Analysis of Horizontally Layered Soil Deposits, Earthfill Dams, and Solid Waste Landfills," *User's Manual*. GeoMotions, LLC, Lacey, Washington, p. 20 (plus Appendices).
- McGuire, R. K. 2004. *Seismic Hazard and Risk Analysis*, Monograph, MNO-10. Earthquake Engineering Research Institute, Oakland, California, p. 221.
- Menq, F. 2003. Dynamic Properties of Sandy and Gravelly Soils, Ph.D. Dissertation, Department of Civil Engineering, University of Texas, Austin.
- Parra, E. 1996. Numerical Modeling of Liquefaction and Lateral Ground Deformation Including Cyclic Mobility and Dilation Response in Soil Systems, Ph.D. Dissertation, Department of Civil Engineering, Rensselaer Polytechnic Institute, Troy, NY.
- Pyke, R. M. 2000. TESS: A Computer Program for Nonlinear Ground Response Analyses. TAGA Engineering Systems & Software, Lafayette, California.
- Ragheb, A. M. 1994. Numerical Analysis of Seismically Induced Deformations in Saturated Granular Soil Strata, Ph.D. Dissertation, Department of Civil Engineering, Rensselaer Polytechnic Institute, Troy, New York.
- Schnabel, P. B., J. Lysmer, and H. B. Seed. 1972. *SHAKE: A Computer Program for Earthquake Response Analysis of Horizontally Layered Sites*, Report EERC 72-12. Earthquake Engineering Research Center, University of California, Berkeley.
- Somerville, P. G., N. F. Smith, R. W. Graves, and N. A. Abrahamson. 1997. "Modification of Empirical Strong Ground Motion Attenuation Relations to include the Amplitude and Duration Effects of Rupture Directivity" *Seismological Research Letters*, 68:199-222.
- Vucetic, M., and R. Dobry. 1991. "Effect of Soil Plasticity on Cyclic Response," *ASCE/SEI Journal of Geotechnical Engineering*, 117(1):89-107.
- Yang, Z. 2000. Numerical Modeling of Earthquake Site Response Including Dilation and Liquefaction, Ph.D. Dissertation, Department of Civil Engineering and Engineering Mech., Columbia University, New York, New York.
- Zhang, J., R. D. Andrus, and C. H. Juang. 2005. "Normalized Shear Modulus and Material Damping Ratio Relationships," *ASCE Journal of Geotechnical and Geoenvironmental Engineering*, 131(4):453-464.
- Zhang, J., R. D. Andrus, and C. H. Juang. 2008. "Model Uncertainty in Normalized Shear Modulus and Damping Relationships," *ASCE Journal of Geotechnical and Geoenvironmental Engineering*, 134(1).

COMMENTARY TO CHAPTER 22, SEISMIC GROUND MOTION AND LONG-PERIOD TRANSITION MAPS

SEISMIC GROUND MOTION MAPS

ASCE/SEI 7-05 continues to use contour maps of spectral response acceleration (Figures 22-1 through 22-14). The spectral acceleration design maps were prepared by the U.S. Geological Survey (USGS) based on USGS probabilistic maps of the 48 conterminous states (2002), Alaska (1998), Hawaii (1998), and Puerto Rico/Virgin Islands (2003) with modifications based on the 1997 recommendations of the Building Seismic Safety Council. The maps of the 48 states and Puerto Rico/Virgin Islands have been updated from the 2002 edition of the standard but the maps of Alaska, Hawaii, Guam, and Tutuila are unchanged. The USGS also has developed a companion software program that calculates location-specific spectral values based on latitude and longitude or zip code; use of zip codes is discouraged in regions where ground-motion values vary substantially over a short distance. The calculated values are based on the data used to prepare the maps. The spectral values should be adjusted for Site Class effects using the Site Classification Procedure in Section 20 and the site coefficients in Section 11.4. Latitude and longitude for a given address can be found at a variety of websites. The companion software program may be accessed at the USGS website (<http://earthquake.usgs.gov/designmaps>). The software program should be used to establish spectral values for design because the maps found in ASCE/SEI 7-05 are too small to provide accurate spectral values for many sites.

LONG-PERIOD TRANSITION MAPS

The maps of the long-period transition period, T_L , (Figures 22-15 through 22-20) were introduced in ASCE/SEI 7-05. They were prepared by the USGS in response to BSSC recommendations and subsequently included in the 2003 edition of the *Provisions*. See Section C11.4.5 for a discussion of the technical basis of these maps. The value of T_L obtained from these maps is used in Equation 11.4-7 to determine values of S_a for periods greater than T_L .

The exception in Section 15.7.6.1, regarding the calculation of S_{ac} , the convective response spectral acceleration for tank response, is intended to provide the user the option of computing this acceleration with three different types of site-specific procedures: (a) the procedures in Chapter 21, provided they cover the natural period band containing T_c , the fundamental convective period of the tank-fluid system, (b) ground-motion simulation methods using seismological models, and (c) analysis of representative accelerogram data. Elaboration of these procedures is provided below.

With regard to the first procedure, attenuation equations have been developed for the western United States (Next Generation Attenuation, Power et al., 2006, 2008) and for the central and eastern United States (e.g., Somerville et al., 2001) that cover the period band, 0 to 10 seconds. Thus, for $T_c \leq 10$ seconds, the fundamental convective period range for nearly all storage tanks, these attenuation equations can be used in the same PSHA/DSHA procedures described in Chapter 21 to compute S_a (T_c). The 1.5 factor in Equation 15.7-11, which converts a 5 percent damped spectral acceleration to a 0.5 percent damped value, could then be applied to obtain S_{ac} . Alternatively, this factor could be established by statistical analysis of 0.5 percent damped and 5 percent damped response spectra of accelerograms representative of the ground motion expected at the site.

In some regions of the United States, such as Pacific Northwest and southern Alaska, where subduction-zone earthquakes dominate the ground-motion hazard, attenuation equations for these events only extend to periods between 3 and 5 s, depending on the equation. Thus, for tanks with T_c greater than these periods, other site-specific methods are required.

The second site-specific method to obtain S_a at long periods is simulation through the use of seismological models of fault rupture and wave propagation (Graves and Pitarka, 2004; Hartzell and Heaton, 1983; Hartzell et al., 1999; Liu et al., 2006; Zeng et al., 1994). These models could range from simple seismic source-theory and wave-propagation models, which currently form the basis for many of the attenuation equations used in the central and eastern United States for example, to more complex numerical models that incorporate finite fault rupture for scenario earthquakes and seismic wave propagation through 2-D or 3-D models of the regional geology, which may include basins. These models are particularly attractive for computing long-period ground motions from great earthquakes ($M_w \geq \sim 8$) because ground-motion data are limited for these events. Furthermore, the models are more accurate for predicting longer-period ground motions because: (a) seismographic recordings may be used to calibrate these models and (b) the general nature of the 2-D or 3-D regional geology is typically fairly well resolved at these periods and can be much simpler than would be required for accurate prediction of shorter period motions.

A third site-specific method is the analysis of the response spectra of representative accelerograms that have accurately recorded long-period motions to periods greater than T_c . As T_c increases, the number of qualified records decreases.

However, as digital accelerographs continue to replace analog accelerographs, more recordings with accurate long-period motions will become available. Nevertheless, a number of analog and digital recordings of large and great earthquakes are available that have accurate long-period motions to 8 seconds and beyond. Subsets of these records, representative of the earthquake(s) controlling the ground-motion hazard at a site, can be selected. The 0.5 percent damped response spectra of the records can be scaled using seismic source theory to adjust them to the magnitude and distance of the controlling earthquake. The levels of the scaled response spectra at periods around T_c can be used to determine S_{ac} . If the subset of representative records is limited, then this method should be used in conjunction with the aforementioned simulation methods.

REFERENCES

- Graves, R. W., and A. Pitarka. 2004. "Broadband Time History Simulation using a Hybrid Approach," Paper 1098 in *Proceedings of the 13th World Conference on Earthquake Engineering*, Vancouver, Canada.
- Hartzell, S., and T. Heaton. 1983. "Inversion of Strong Ground Motion and Teleseismic Waveform Data for the Fault Rupture History of the 1979 Imperial Valley, California Earthquake," *Bulletin of the Seismological Society of America*, 73:1553-1583.
- Hartzell, S., S. Harmsen, A. Frankel, and S. Larsen. 1999. "Calculation of Broadband Time Histories of Ground Motion: Comparison of Methods and Validation Using Strong Ground Motion from the 1994 Northridge Earthquake," *Bulletin of the Seismological Society of America*, 89:1484-1504.
- Liu, P., R. J. Archuleta, and S. H. Hartzell. 2006. "Prediction of Broadband Ground-Motion Time Histories: Hybrid Low/High-Frequency Method with Correlated Random Source Parameters," *Bulletin of the Seismological Society of America*, 96:2118–2130.
- Power, M., B. Chiou, N. Abrahamson, Y. Bozorgnia, T. Shantz, and C. Roblee. 2008. "An Overview of the NGA Project," *Earthquake Spectra Special Issue on the Next Generation of Ground Motion Attenuation (NGA) Project*." Earthquake Engineering Research Institute, March.
- Power, M., B. Chiou, N. Abrahamson, and C. Roblee. 2006. "The Next Generation of Ground Motion Attenuation Models," in *Proceedings of the 100th Anniversary Earthquake Conference Commemorating the 1906 San Francisco Earthquake*, San Francisco, California.
- Somerville, P. G., N. Collins, N. Abrahamson, R. Graves, and C. Saikia. 2001. *Earthquake Source Scaling and Ground Motion Attenuation Relations for the Central and Eastern United States*, Final Report to the USGS under Contract 99HQGR0098.
- Zeng, Y., J. G. Anderson, and G. Yu. 1994. "A Composite Source Model for Computing Synthetic Strong Ground Motions," *Geophys. Research Letters*, 21:725-728.

2009 NEHRP Recommended Seismic Provisions for New Buildings and Other Structures:

PART 3, RESOURCE PAPERS (RP) ON SPECIAL TOPICS IN SEISMIC DESIGN

This part of the 2009 NEHRP Recommended Seismic Provisions consists of a series of resource papers that include:

- *Proposals for code and standard changes reflecting new and innovative concepts or technologies that are judged, at the time of publication of this edition of the Provisions, to require additional exposure to those who use codes and standards and to possibly require systematic trial use. Some of these potential future changes are formatted for direct adoption while others discuss only the thrust of the proposed change.*
- *Discussions of topics that historically have been difficult to adequately codify. These papers provide background information intended to stimulate further discussion and research and, eventually, code change proposals.*

Like Parts 1 and 2 of this volume, these resource papers have been approved for inclusion in this volume by both the 2009 Provisions Update Committee and the BSSC membership.

Comments and questions about the topics treated in these Part 3 resource papers should be addressed to:

*Building Seismic Safety Council
National Institute of Building Sciences
1090 Vermont Avenue, N.W., Suite 700
Washington, D.C. 20005
(202) 289-7800, Fax: (202) 289-1092, E-mail: bssc@nibs.org*

Page intentionally left blank.

Resource Paper 1

ALTERNATE MATERIALS, DESIGN, AND METHODS OF CONSTRUCTION

Early in its deliberations, the 2009 Provisions Update Committee (PUC) established Issue Team 1, Performance Criteria, to develop a proposal that would encourage the development of construction equivalent to that provided by prescriptive provisions but possibly offering economic, performance, or construction speed advantages. The PUC took this step in light of an ongoing FEMA-funded project to develop a recommended methodology for reliably quantifying building system performance and response parameters for use in seismic design, in response to growing interest in performance-based design and its use to develop alternate designs equivalent to prescriptive code provisions, and in recognition of the fact that a lack of guidance on methods of approval for such submittals might discourage the creation of needed review processes in some jurisdictions.

This paper was initially prepared by BSSC 2009 Issue Team 1 as a proposal for a Provisions Part 1 modification to Section 11.1.4 of ASCE/SEI 7-05. The voting by the BSSC member organizations, however, resulted in many comments about: use of the new methodology prior to completion of the FEMA project and/or prior to complete vetting of the project recommendations, approval methods for components and products on a smaller scale than full building systems, and the lack of specificity in the suggested approval processes. Although the issue team developed complete responses to these comments, the majority of the team recommended interim placement in Part 3 of the Provisions. Due to the high interest and need for guidance on approval of submittals under the Alternate Means section, it is recommended that this or a similar change be considered for inclusion in ASCE/SEI 7-05 as soon as possible.

PROPOSED CHANGE

Rearrange ASCE/SEI 7-05 Section 11.1.4.1 and add new Sec 11.1.4.2 as shown below (additions underlined).

11.1.4 Alternate Materials, Design, and Methods of Construction.

11.1.4.1 General. The provisions of this standard are not intended to prevent the use of any material, alternate design method, or alternate method of construction not specifically prescribed, provided that any such alternate has been approved and its use authorized by the authority having jurisdiction. The authority having jurisdiction may approve any such alternate, provided that the authority finds that the alternate is satisfactory and complies with the intent of the provisions of this standard, and that the alternate is, for the purpose intended, at least the equivalent of that prescribed in this standard in suitability, effectiveness, durability, and seismic resistance.

11.1.4.2 Approval of Proposals Under Sec 11.1.4. Nothing in this section shall limit the ability of the authority having jurisdiction to develop or accept general requirements for proposals under Section 11.1.4 or specific requirements for particular components or systems, such as acceptance of reports from evaluation services or other demonstration of equivalence as specified in Section 11.1.4.1. In the absence of such criteria, the approval process shall include the following elements:

11.1.4.2.1 Peer Review. Peer review of the preliminary submittal, final design, and/or construction documents.

11.1.4.2.2 Preliminary Submittal. A submittal of a detailed description and, if applicable, design criteria for the alternate material or method, for approval by the authority having jurisdiction, prior to application for a building permit.

11.1.4.2.3 Structural Design Criteria. For submittals requesting use of alternate materials, alternate design methods or alternate methods of construction for the complete seismic-force-resisting system, a structural design criteria shall be included based on the seismic performance for the Performance Category, as described in the 2006 International Code Council Performance Code, that is equivalent to the Occupancy Category of the building.

The design criteria submittal shall demonstrate how the required seismic performance will be met by generally following one of the two methods described below:

1. Nonlinear procedures described in ASCE/SEI 41-06, *Seismic Rehabilitation of Existing Buildings*.
2. Probabilistic nonlinear analysis methods of *Quantification of Building Seismic Performance Factor*, FEMA P-695. Using these methods, it shall be demonstrated that for the required performance objectives there is an acceptably low probability of not reaching the specified performance level, given the specified ground motion.

11.1.4.2.4 Nonstructural Design Criteria. For seismic protection of nonstructural components not part of a designated seismic system, the design shall demonstrate that the components and systems are capable of remaining secured to the structure and will not generate life-threatening debris under the Design Earthquake Ground Motion. For designated seismic systems and components of such systems, the design shall demonstrate that the components and systems will be capable of remaining functional following design level shaking. The procedures of Section 13.2.5 and 13.2.6 may be applied as satisfactory fulfillment of these requirements.

Resource Paper 2

NONLINEAR STATIC PROCEDURE

This resource paper was prepared by Technical Subcommittee 2, Design Criteria and Analysis and Advanced Technologies, as a replacement for the Appendix to Chapter 5 of the 2003 edition of the NEHRP Recommended Provisions. It revises the information on the nonlinear static procedure (NSP) to allow its use in design of regular buildings less than 40 feet in height. The principal value of this approach as currently presented is for the design of buildings that are controlled by drift limits. Such buildings can be designed to have sufficient stiffness without using the equivalent lateral force (ELF) procedure and to have sufficient strength without conducting detailed member evaluations ($R_d < R/\Omega_0$). In the future, the height limitation may be relaxed if, for example, the NSP is used in conjunction with a nonlinear dynamic analysis.

Because requirements for the nonlinear static procedure are now specified in ASCE/SEI 41-06, it is simpler to refer to that document than to write applicable requirements into the Provisions. Modifications to the ASCE/SEI 7-05 requirements are introduced here to maintain consistency with the nonlinear static procedure information presented in the 2003 Provisions.

The 40-foot height limit was selected based on the accuracy of response quantities determined for a three-story moment-frame structure; no height limit was identified in the FEMA-funded Applied Technology Council project on the evaluation of inelastic seismic analysis procedures (Improvement of Nonlinear Static Seismic Analysis Procedures, FEMA 440). Although higher modes will have a similar influence on ELF quantities, the higher base shear strengths and story shears of the ELF procedure will tend to result in smaller member ductility demands. Thus, precision in the NSP estimates is especially important when system strengths are lower than those resulting from use of the ELF approach, which evaluates member deformation demands in detail.

This resource paper simplifies the language used to establish whether lateral strength is nominally less than that required by the ELF procedure. This is now stated succinctly as $R_d > R/\Omega_0$. Section references have been harmonized with ASCE/SEI 7-05 section numbers. If adopted for ASCE/SEI 7-10 or subsequent editions, the chapter number assigned to the requirements portion of this paper will have to be substituted where "X" appears below.

REQUIREMENTS

X Nonlinear Static Procedure

X.1 Definitions

Target Displacement. An estimate of the maximum expected displacement of the control node, determined according to Section 3.3.3.3.2 of ASCE/SEI 41 Supplement 1 using S_a defined as a design earthquake spectral response acceleration according to the 2009 *NEHRP Recommended Seismic Provisions* at the effective period.

X.2 Notation

Q_{Ei}	Force in i^{th} member determined according to Section 12.15.8.
R_d	The system strength ratio as determined by Equation X-1.
R_{max}	The maximum strength ratio, defined by Equation 3-16 of ASCE/SEI 41 Supplement 1.
γ_i	The deformations for member i .
Ω_0	See Section 11.3.

X.3 Applicability. Regular structures less than 40 feet in height in Occupancy Categories I and II may be designed using the nonlinear static procedure following the requirements of this chapter.

X.4 Seismic-force-resisting System. The seismic-force-resisting system shall conform to one of the types in Tables 12.2-1 and 15.4-1 and shall be in accordance with the seismic design category and height limitations indicated in these tables. The appropriate response modification coefficient, R , and system overstrength factor, Ω_0 , identified in these tables shall be used, subject to the additional requirements of this chapter.

X.5 Modeling and Analysis. Modeling and analysis shall conform to Section 3.3.3 of ASCE/SEI 41 Supplement 1 except that: (a) S_a shall be defined as a design earthquake spectral response acceleration according to the *NEHRP Recommended Seismic Provisions* at the effective period and (b) the analysis shall be conducted for seismic actions occurring simultaneously with the effects of dead load in combination with not less than 25 percent of the required design live loads,

reduced as permitted for the area of a single floor. P-delta effects shall be included in the analysis model, and dead and live loads acting on the entire structure shall be represented in the model.

X.6 Maximum Strength Ratio. The system strength ratio, R_d , is given by Equation X-1 as follows:

$$R_d = \frac{S_a}{V_y / W} C_m \quad (\text{X-1})$$

where C_m , V_y , and W are as defined in Section 3.3.3.3.2 of ASCE/SEI 41 Supplement 1 and S_a is defined as a design earthquake spectral response acceleration according to the 2009 NEHRP Recommended Seismic Provisions at the effective period. Use of the nonlinear static procedure is not permitted when R_d exceeds R_{max} .

X.7 Story Drift. The design story drift, Δ , taken as the value obtained for each story at the step at which the target displacement is reached, shall not exceed the drift limit specified in Section 12.12.1 multiplied by $0.85R/C_d$.

X.8 Member Strength. In addition to satisfying the requirements of Section 12.15.9, member strengths also shall satisfy the requirements of Section 2.3 using $E = 0$, except that Section 12.4.3.2 shall apply when the effect of structural overstrength on the design seismic force must be considered. When the effect of structural overstrength is considered, the value of the individual member forces, Q_{Ei} , obtained from the analysis at the target displacement shall be taken in place of the quantity $\Omega_0 Q_E$.

X.9 Detailed Evaluation. Detailed evaluation satisfying Sections X.9.1 and X.9.2 is required if R_d exceeds R/Ω_0 .

X.9.1 Required Member Force and Deformation. For each nonlinear static analysis, the design response parameters, including the individual member forces, Q_{Ei} , and member deformations, γ_i , shall be taken as the values obtained from the analysis at the step at which the target displacement is reached.

X.9.2 Member Capacity. The adequacy of individual members and their connections to withstand the member forces, Q_{Ei} , and member deformations, γ_i , shall be evaluated based on laboratory test data for similar components. The effects of gravity and other loads on member deformation capacity shall be considered in these evaluations. The deformation of a member supporting gravity loads shall not exceed: (a) two-thirds of the deformation that results in loss of ability to support gravity loads and (b) two-thirds of the deformation at which the member strength has deteriorated to less than the 70 percent of the peak strength of the component model. The deformation of a member not required for gravity load support shall not exceed two-thirds of the value at which member strength has deteriorated to less than 70 percent of the peak strength of the component model. Alternatively, it shall be permissible to deem member deformation to be acceptable if the deformation does not exceed the value provided in ASCE/SEI 41 Supplement 1 for the Life Safety performance level.

Member forces shall be deemed acceptable if not in excess of expected capacities.

X.10 Design Review. A review of the design of the seismic-force-resisting system and the supporting structural analyses shall be performed by an independent team having experience in seismic analysis methods and the theory and application of nonlinear seismic analysis and structural behavior under earthquake loading. The team shall be composed of at least two members including at least one registered design professional. The design review shall include:

1. Review of any site-specific seismic criteria employed in the analysis including the development of site-specific spectra and
2. Review of the determination of the target displacement and effective yield strength of the structure.

For those structures with R_d exceeding R/Ω_0 , the design review shall further include, but need not be limited to, the following:

1. Review of acceptance criteria used to demonstrate the adequacy of structural elements and systems to withstand the calculated force and deformation demands together with the laboratory and other data used to substantiate such criteria. Review of the acceptance criteria for nonlinear procedures given in ASCE/SEI 41 Supplement 1 shall be at the discretion of the design review team.
2. Review of the final design of the entire structural system and all supporting analyses.

The design review team shall issue a report that identifies, within the scope of the review, significant concerns and any departures from general conformance with the NEHRP Recommended Provisions.

COMMENTARY

This resource paper presents proposed requirements for nonlinear static analysis, a seismic analysis procedure also sometimes known as pushover analysis, for review and comment and for adoption into a subsequent edition of the *NEHRP Recommended Provisions*.

Although nonlinear static analysis has only recently been included in design provisions for new building construction, the procedure itself is not new and has been used for many years in both research and design applications. For example, nonlinear static analysis has been used for many years as a standard methodology in the design of the offshore platform structures for hydrodynamic effects and has been adopted recently in several standard methodologies for the seismic evaluation and rehabilitation of building structures, including the *Recommended Seismic Design Criteria for New Steel Moment-Frame Buildings* (FEMA 350, 2000), *Seismic Rehabilitation of Existing Buildings* (ASCE/SEI 41-06, 2007), and *Seismic Evaluation and Retrofit of Concrete Buildings* (Applied Technology Council, 1996). Nonlinear static analysis also forms the basis for earthquake loss estimation procedures contained in the earthquake module of the multihazard software application HAZUS-MH MR2 (FEMA, 2006) and its Advanced Engineering Building Module (FEMA, 2002). A critical review of and improvement to nonlinear static analysis methods, *Improvement of Nonlinear Static Seismic Analysis Procedures*, was published as FEMA 440 in 2005. Although it does not explicitly appear in the *Provisions*, the nonlinear static analysis methodology also forms the basis for the equivalent lateral force procedures contained in the provisions for base-isolated structures and structures with dampers.

One of the controversies surrounding the introduction of this methodology into the *Provisions* relates to the determination of the limit deformation (sometimes called a target displacement). Several methodologies for estimating the amount of deformation induced in a structure as a result of earthquake ground shaking have been proposed and are included in various adoptions of the procedure. The approach presented in this paper is based on statistical correlations of the displacements predicted by linear and nonlinear dynamic analyses of structures recommended in the FEMA 440 report (2005) on the evaluation of inelastic seismic analysis procedures.

A second controversy relates to the limited availability of consensus-based acceptance criteria to be used to determine the adequacy of a design once the forces and deformations produced by design earthquake ground shaking are estimated. It should be noted that this limitation applies equally to the nonlinear response history approach, which already has been adopted into building codes.

A third controversy relates to the effects of higher modes (or multi-degree-of-freedom effects for structures responding nonlinearly) on response quantities. FEMA 440 identifies significant disparities between response quantities determined by nonlinear static analysis and those determined by nonlinear dynamic analysis for all but low-rise structures; therefore, use of the nonlinear static procedure for the design of members proposed here is limited to structures 40 feet or less in height. This limitation has resulted in the nonlinear static procedure being located in Part 3 of the *Provisions*. The nonlinear static procedure may be used to ensure that structures designed according to the equivalent lateral force procedure achieve strengths comparable to code expectations. Interstory drifts are compared with tabulated allowable story drifts to maintain consistency with past practice, although it is recognized that larger interstory drifts should be anticipated due to higher mode or multi-degree-of-freedom effects.

Nonlinear static analysis provides a simplified method of directly evaluating nonlinear response of structures to strong earthquake ground shaking that can be an attractive alternative to the more complex procedures of nonlinear response history analysis. It may be useful for characterizing system strength and stiffness and for establishing that the structure develops a desirable inelastic mechanism.

REFERENCES

- American Society of Civil Engineers/Structural Engineering Institute. 2006. *Seismic Rehabilitation of Existing Buildings*, ASCE/SEI 41-06, with Supplement 1. American Society of Civil Engineers, Reston, Virginia.
- Applied Technology Council. 1996. *Seismic Evaluation and Retrofit of Concrete Buildings*, SSC Report 96-01. Seismic Safety Commission, State of California, Sacramento, California.
- Applied Technology Council. 2005. *Improvement of Nonlinear Static Seismic Analysis Procedures*, FEMA 440. FEMA, Washington, D.C.
- Building Seismic Safety Council. 2003. *NEHRP Recommended Provisions for the Development of Seismic Regulations for New Buildings and Other Structures*, FEMA 450. FEMA, Washington, D.C.

Federal Emergency Management Agency. 2006. *HAZUS-MH MR2 Multi-hazard Loss Estimation Methodology, Earthquake Model, Technical Manual*. Prepared for FEMA by the National Institute of Building Sciences. FEMA, Washington, D.C.

Federal Emergency Management Agency. 2002. *Earthquake Loss Estimation Methodology, HAZUS99-SR2, Advanced Engineering Building Module, Technical and User's Manual*. Prepared for FEMA by National Institute of Building Sciences. FEMA, Washington, D.C.

Federal Emergency Management Agency. 2000. *Recommended Seismic Design Criteria for New Steel Moment-Frame Buildings*, FEMA 350. FEMA, Washington, D.C.

Resource Paper 3

SEISMIC-RESPONSE-HISTORY ANALYSIS

This resource paper was developed by Technical Subcommittee 2, Design Criteria and Analysis and Advanced Technologies, as a replacement for ASCE/SEI 7-05 Chapter 16, Seismic Response-History Analysis. It reorganizes the chapter to eliminate redundancy as well as inconsistencies and duplication of ASCE/SEI 7-05 Chapter 12 analysis requirements. When response-history analyses (RHA) are used, they are commonly used as a maximum considered earthquake verification after a preliminary design has been completed. This paper adds a number of important requirements for RHA conducted at the risk-targeted maximum considered earthquake level. Feedback will be appreciated.

PROPOSED REPLACEMENT FOR ASCE/SEI 7-05 CHAPTER 16, SEISMIC-RESPONSE-HISTORY ANALYSIS

16.1 GENERAL REQUIREMENTS

A response-history analysis (RHA) shall consist of an analysis of a mathematical model of the structure to determine, through methods of numerical integration, its response to suites of ground motion acceleration histories. The analysis shall be performed in accordance with the requirements of this chapter. Structures with elements of the seismic-force-resisting system responding significantly beyond their elastic limit shall satisfy Section 16.3.12. When the analysis is used to validate a design that uses the exceptions in Section 16.1.1, the ground motions shall be scaled to the risk-targeted maximum considered earthquake (MCE_R) ground motion level in accordance with Section 16.2 and the acceptance criteria shall meet Section 16.4.

16.1.1 Design Requirements. The design of the structure shall meet all requirements for equivalent lateral force or modal response spectrum analysis in accordance with Section 12.6 except that specific exceptions to such requirements are permitted to be taken, provided the exceptions are:

1. Identified clearly in the documentation submitted for design review and
2. Justified through rational application of the RHA.

16.1.2 Level of Ground Motion. The analysis shall be based on the MCE_R ground motions defined in Section 11.4.

16.1.3 Occupancy Categories III and IV. For Occupancy Categories III and IV, the ground motion is in accordance with Section 16.1.2, but the acceptance criteria in accordance with Section 16.4 are more restrictive compared to values applicable to Occupancy Categories I and II. When alternative acceptance criteria are used, they shall be demonstrated to be consistent with the importance factor, I , in accordance with Section 11.5. Nonstructural elements shall be designed in accordance with Chapter 13 using I_p as required by Section 13.1.3.

16.2 GROUND MOTION

A suite of not less than seven appropriate ground motions shall be used in the analysis.

Appropriate ground motion acceleration histories shall be obtained from records of events having magnitudes, fault distances, and source mechanisms that are consistent with those that control the MCE_R . If a sufficient number of appropriate recorded ground motion records is not available, appropriate simulated or modified ground motion records are permitted to be used to as part of the total number required.

When applicable, the ground motion acceleration histories shall include near fault and directivity effects including direction of fault rupture and velocity pulses as appropriate.

16.2.1 Duration. Each response-history analysis shall be run for the full duration of the ground motion except that the first or last portion of the record is permitted to be truncated provided that the truncation does not significantly modify either the frequency content or the number of cycles of ground motion with an amplitude sufficient to induce nonlinear response.

16.2.2 Two-dimensional Analysis. When two-dimensional analyses are performed, each ground motion shall consist of a horizontal acceleration history. The ground motions shall be scaled such that the average value, over all ground motions, of the 5-percent-damped response spectra for the suite of motions is not less than the MCE_R response spectrum for the site for periods ranging from $0.2T$ to $1.5T$ where T is the natural period of the structure in the fundamental mode for the direction of response being analyzed.

16.2.3 Three-dimensional Analysis. When three-dimensional analysis is performed, ground motions shall consist of pairs of appropriate horizontal ground motion acceleration components. For each pair of horizontal ground motion components, a square root of the sum of the squares (SRSS) spectrum shall be constructed by taking the SRSS of the 5-percent-damped response spectra for the scaled components (for direct scaling, an identical scale factor is applied to both components of a pair). Each pair of motions shall be scaled such that for each period between $0.2T$ and $1.5T$, the average, over all component pairs, of the SRSS spectra does not fall below 1.3 times the corresponding ordinate of the MCE_R response spectrum by more than 10 percent.

16.3 MODELING AND ANALYSIS

Mathematical models shall conform to the requirements of Section 12.7. Design review requirements are described in Section 16.5.

16.3.1 Interaction of Elements. The analysis shall consider the interaction of all structural and nonstructural elements that can adversely affect the response of the structure to earthquake ground motions, including elements not designated as part of the seismic-force-resisting system.

16.3.2 Identification of Nonlinear Response. Documentation submitted for design review shall identify the elements in the seismic-force-resisting system (SFERS) designed for nonlinear seismic response. All other elements in the SFERS shall be demonstrated by analysis to remain essentially elastic (refer to Section 16.4.3).

16.3.3 Two-dimensional Analysis. A two-dimensional analysis model is permitted to be used if Section 12.7.3 does not require a three-dimensional model or if documentation submitted for design review demonstrates that the two-dimensional analysis captures all significant three-dimensional effects including plan torsion, non-orthogonal earthquake response, engagement of overturning resistance through flange effects or transverse coupling, and non-orthogonal effects on strong-column weak-beam behavior.

16.3.4 Direction of Loading. Two-dimensional modeling shall account for direction of loading effects in accordance with Section 12.5.

16.3.5 Diaphragm Modeling. Floor and roof diaphragms responding linearly shall be modeled according to Section 12.3.1. Diaphragms responding beyond the linear range shall be modeled using nonlinear force-deformation relationships if required by Section 16.3.11

16.3.6 Seismic Mass. The masses used in the analytical model shall be as defined in Section 12.7.2. When modal computation techniques are used for response-history computation, Section 12.9.1 shall be satisfied and the results shall be multiplied by the ratio of the total mass to the mass participating in the modes included in the analysis.

16.3.7 Gravity Load. The modeling of and demands on elements in the analysis model shall be determined considering earthquake effects acting in the presence of expected gravity loads. For building structures with ordinary occupancies, expected gravity loads shall be taken as $1.0D + 0.5L$

For live loads subject to reduction on the basis of area in accordance with Section 4.8, the tributary area shall be permitted to be taken as the total floor area in the structure subject to that live load and K_{LL} shall be set to 1.0.

For other occupancies or when the expected gravity load is not well represented by $1.0D + 0.5L$ or is highly variable, the analysis shall be modified accordingly.

16.3.8 P-delta Effects. P-delta effects shall be included in the analysis using the gravity loads defined in Section 16.3.7.

16.3.9 Inherent Plan Torsion. Inherent plan torsion shall be included in accordance with Section 12.8.4.1.

16.3.10 Accidental Plan Torsion. If the accidental torsion requirements of Section 12.8.4.2 are included in the determination of the strength of the nonlinear elements of the structure and in the analysis used to meet the requirements of Section 16.1.1, inclusion of accidental torsion in the RHA is not required.

16.3.11 Nonlinear Modeling. The mathematical model shall directly account for the nonlinear hysteretic behavior of the members and connections that comprise the structural elements.

The hysteretic force-deformation behavior of elements shall be modeled consistent with applicable laboratory test data and shall account for all significant yielding, strength degradation, stiffness degradation, hysteretic pinching, and interaction effects indicated by such test data. Strength of elements shall be based on expected values considering material overstrength, strain hardening, and hysteretic strength degradation at the expected range of deformation. The behavior model shall not be extended to deformations beyond levels substantiated by test data.

Linear properties, consistent with the requirements of Section 12.7.3, are permitted to be used for those elements demonstrated by the analysis to remain within their linear range of response.

16.3.12 Stiffness. To the extent that such effects are significant for the MCE_R response, element properties shall account for the following:

1. Stiffness properties of reinforced concrete and reinforced masonry shall account for cracking and other phenomena that affect effective initial stiffness including strain penetration, bond slip, joint and panel zone deformation, and tension shift associated with shear cracking.
2. Stiffness properties of steel or other connected elements shall account for connection stiffness and, for moment frames, the effect of panel zone (beam-column joint) deformations.

16.3.13 Damping. The equivalent viscous damping level shall not exceed 5 percent of critical damping for any mode required to obtain the effective mass according to Section 12.7.2 unless substantiated. Documentation submitted for design review shall identify how damping effects are included in the RHA to account for energy dissipation that is not considered directly in the nonlinear analysis model.

16.4 ANALYSIS RESULTS

16.4.1 Design Values. The calculation of design values shall account for the signs of response parameters and the combinations of response parameters (e.g., axial force and bending moment) that can govern the design.

16.4.2 Analysis Results. The response parameters of interest shall be calculated for each ground motion used for the RHA. The peak value of each parameter shall be determined for each ground motion. The average of the peaks shall be used for checking acceptance criteria. When a combination of response parameters is important (e.g., for elements resisting both flexural and axial forces), these results shall be captured to be consistent with the acceptance criteria.

16.4.3 Acceptance Criteria for Ductile Behavior. Element response that satisfies the definition for deformation-controlled actions in Section 2.4.4.3 of ASCE/SEI 41 shall be evaluated on the basis of either nonlinear or linear behavior. If the calculated force in an element does not exceed 1.5 times its nominal strength, that element is permitted to be considered linear (essentially elastic).

16.4.3.1 Nonlinear Behavior of Ductile Elements. Member deformation shall not result in deterioration of its attainable member strength to less than 80 percent of the peak resistance. Deformation capacities shall be based on values tabulated in ASCE/SEI 41 or from laboratory test data for similar elements. When ASCE/SEI 41 is used, the following performance levels are to be used:

1. Collapse prevention for Occupancy Categories I and II,
2. Life safety for Occupancy Category IV, and
3. 80 percent of collapse prevention but not less than life safety for Occupancy Category III.

Documentation shall be submitted for design review to substantiate the adequacy of individual elements and their connections to withstand the deformation demands from the RHA.

16.4.3.2 Linear Behavior of Ductile Elements. Calculated force demands shall not exceed 150 percent of nominal capacities divided by the importance factor, I .

16.4.4 Acceptance Criteria for Nonductile Behavior. Any type of element response that does not satisfy the definition for deformation-controlled actions in Section 2.4.4.3 of ASCE/SEI 41 shall be evaluated on a linear basis. The demands from Section 16.4.2 shall not exceed the expected strength. Nominal strength is permitted to be used in lieu of expected strength.

16.4.5 Story Drift. The story drift ratio shall not exceed 1.5 times the limits of Section 12.12.1 for any story unless those elements not designated as part of the seismic-force-resisting system are capable of undergoing the calculated story drift for each RHA without collapse of the portion of the structure supported by those elements.

16.4.6 Stability. The structure shall be shown to be stable for the MCE_R ground motions.

16.5 Design Review. A design review of the seismic-force-resisting system, the structural analysis, and the documentation shall be performed by an independent team of registered design professionals in the appropriate disciplines and others experienced in seismic analysis methods and the theory and application of nonlinear seismic analysis and structural behavior under extreme cyclic loads. The design review shall include, but need not be limited to, the following:

1. Review of any site-specific seismic criteria employed in the analysis including the development of site-specific spectra and ground motion time histories.

2. Review of acceptance criteria used to demonstrate the adequacy of structural elements and systems to withstand the calculated force and deformation demands and laboratory and other data that substantiate these criteria.
3. Review of the preliminary design including the selection of structural system and the configuration of structural elements.
4. Review of the final design of the entire structural system and all supporting analyses.

Resource Paper 4

FOUNDATION GEOTECHNICAL ULTIMATE STRENGTH DESIGN AND FOUNDATION LOAD-DEFORMATION MODELING (2003 Provisions Appendix to Chapter 7, Foundation Design Requirements)

This resource paper originally appeared as the appendix to Chapter 7, Foundation Design Requirements, of the 2003 NEHRP Recommended Provisions. It includes ultimate strength design (USD) procedures for the geotechnical design of foundations for trial use and evaluation by design professionals prior to adoption into a subsequent edition of the Provisions. Similarly, the resource paper presents criteria for the modeling of load-deformation characteristics of the foundation-soil system (foundation stiffness) for those analysis procedures in Chapter 5 of the 2003 Provisions that permit use of realistic assumptions for foundation stiffness rather than the assumption of a fixed base. Note that only format changes have been made and Provisions section numbers cited refer to the 2003 edition of the Provisions.

Practice for geotechnical foundation design has been based on allowable stresses with allowable foundation load capacities for dead plus live loads based on limiting long-term static settlements and providing a large factor of safety. In current practice, allowable soil stresses for dead plus live loads are typically increased by one-third for load combinations that include wind or seismic forces. The allowable stresses for dead plus live loads are often far below ultimate soil capacity. This resource paper's Provisions and the associated Commentary provide criteria and guidance for the direct use of ultimate foundation load capacity for load combinations that include seismic forces. The acceptance criteria cover both the analyses for fixed-base assumptions and analyses for linear and nonlinear modeling of foundation stiffness for flexible-base assumptions.

Although USD for foundations has not previously been included in design provisions for new buildings, the same basic principles used in this resource paper have been adapted to generate guidelines for the seismic evaluation and retrofit design of existing buildings (FEMA 273; FEMA 356; Applied Technology Council, 1996). The criteria and procedures presented herein for the nonlinear modeling of foundation stiffness combine a linear or multilinear stiffness and a limiting load capacity based on ultimate soil strength and are essentially the same as those presented in the publications cited above.

With respect to the adoption of USD procedures for geotechnical foundation design, the primary issue considered by the 2003 Provisions Update Committee and the BSSC member organizations was the impact of the proposed USD procedures on the size of foundations and the consequent effect on the potential for foundation rocking and building performance. A synopsis of two sets of design examples is presented at the end of this resource paper. The example results illustrate the expected effects of the methodology in that relative foundation sizes from USD vs. ASD are related to the factor of safety on load capacity under vertical dead plus live loads. When factors of safety are high, smaller foundations result from USD, but when factors of safety are low, it is possible that foundations may be larger using USD. Additional examples, including nonlinear dynamic analyses incorporating nonlinear load-deformation models for foundation soil stiffness and capacity, are warranted to further evaluate and possibly refine the methodologies and criteria presented in this paper. It is hoped that trial usage of the methodologies presented herein will allow the necessary consensus to be developed to permit later incorporation into the Provisions. Feedback will be appreciated.

APPENDIX TO 2003 PROVISIONS CHAPTER 7, FOUNDATION DESIGN REQUIREMENTS

A7.1 General

A7.1.1 Scope. This resource paper includes only those foundation requirements that are specifically related to seismic resistant construction. It assumes compliance with all other basic requirements which include, but are not limited to, requirements for the extent of the foundation investigation, fills to be present or to be placed in the area of the structure, slope stability, subsurface drainage, settlement control, and soil bearing and lateral soil pressure recommendations for loads acting without seismic forces.

A7.1.2 Definitions

Allowable foundation load capacity: See Section A7.2.2.

Ultimate foundation load capacity: See Section A7.2.2.

A7.1.3 Notation

- Q_{as} Allowable foundation load capacity.
 Q_{us} Ultimate foundation load capacity.
 ϕ The strength reduction, capacity reduction, or resistance factor.

A7.2 General Design Requirements

The resisting capacities of the foundations, subjected to the load combinations prescribed elsewhere in these *Provisions*, shall meet the requirements of this resource paper.

A7.2.1 Foundation Components. The strength and detailing of foundation components under seismic loading conditions, including foundation elements and attachments of the foundation elements to the superstructure, shall comply with the requirements of Chapters 8, 9, 10, 11, or 12, unless otherwise specified in this chapter. The strength of foundation components shall not be less than that required for load combinations that do not include seismic load effects.

A7.2.2 Foundation Load Capacities. The vertical capacity of foundations (footings, piles, piers, mats or caissons) as limited by the soil shall be sufficient to support the structure for all prescribed load combinations without seismic forces, taking into account the settlement that the structure can withstand while providing an adequate factor of safety against failure. Such capacities are defined as allowable foundation load capacities, Q_{as} . For load combinations including seismic load effects as specified in Section 4.2.2, vertical, lateral, and rocking load capacities of foundations as limited by the soil shall be sufficient to resist loads with acceptable deformations, considering the short duration of loading, the dynamic properties of the soil, and the ultimate load capacities, Q_{us} , of the foundations under vertical, lateral, and rocking loading.

A7.2.2.1 Determination of Ultimate Foundation Load Capacities. Ultimate foundation load capacities shall be determined by a qualified geotechnical engineer based on geotechnical site investigations that include field and laboratory testing to determine soil classification and soil strength parameters, and/or capacities based on insitu testing of prototype foundations. For competent soils that do not undergo strength degradation under seismic loading, strength parameters for static loading conditions shall be used to compute ultimate load capacities for seismic design. For sensitive cohesive soils or saturated cohesionless soils, the potential for earthquake induced strength degradation shall be considered.

Ultimate foundation load capacities, Q_{us} , under vertical, lateral, and rocking loading shall be determined using accepted foundation design procedures and principles of plastic analysis. Calculated ultimate load capacities, Q_{us} , shall be best-estimated values using soil properties that are representative average values for individual foundations. Best-estimated values of Q_{us} shall be reduced by resistance factors (ϕ) to reflect uncertainties in site conditions and in the reliability of analysis methods. The factored foundation load capacity, ϕQ_{us} , shall then be used to check acceptance criteria, and as the foundation capacity in foundation nonlinear load-deformation models.

If ultimate foundation load capacities are determined based on geotechnical site investigations including laboratory or in-situ tests, ϕ factors equal to 0.8 for cohesive soils and 0.7 for cohesionless soils shall be used for vertical, lateral, and rocking resistance for all foundation types. If ultimate foundation load capacities are determined based on full-scale field-testing of prototype foundations, ϕ factors equal to 1.0 for cohesive soils and 0.9 for cohesionless soils are permitted.

A7.2.2.2 Acceptance Criteria. For linear analysis procedures (Sections 5.2, 5.3, and 5.4), factored foundation load capacities, ϕQ_{us} , shall not be exceeded for load combinations that include seismic load effects.

For the nonlinear response history procedure (Section 5.5) and the nonlinear static procedure (Appendix to Chapter 5), if the factored foundation load capacity, ϕQ_{us} , is reached during seismic loading, the potential significance of associated transient and permanent foundation displacements shall be evaluated. Foundation displacements are acceptable if they do not impair the continuing function of Seismic Use Group III structures or the life safety of any structure.

For nonlinear analysis procedures, an additional evaluation of structural behavior shall be performed to check potential changes in structural ductility demands due to higher than anticipated foundation capacity. For this additional evaluation, values of Q_{us} shall be increased by the factor $1/\phi$.

A7.2.3 Foundation Load-deformation Modeling. When permitted for the analysis procedures in Chapter 5 and the Appendix to Chapter 5, the load-deformation characteristics of the foundation-soil system (foundation stiffness), if included in the analysis, shall be modeled in accordance with the requirements of this section. For linear analysis methods, the linear load-deformation behavior of foundations shall be represented by an equivalent linear stiffness using soil properties that are compatible with the soil strain levels associated with the design earthquake motion. The strain-compatible shear modulus, G , and the associated strain-compatible shear wave velocity, v_s , needed for the evaluation of equivalent linear stiffness shall be determined using the criteria in Section 5.6.2.1.1 or based on a site-specific study. Parametric variations of not less than 50

percent increase and decrease in stiffness shall be incorporated in dynamic analyses unless smaller variations can be justified based on field measurements of dynamic soil properties or direct measurements of dynamic foundation stiffness.

For nonlinear analysis methods, the nonlinear load-deformation behavior of the foundation-soil system may be represented by a bilinear or multilinear curve having an initial equivalent linear stiffness and a limiting foundation capacity. The initial equivalent linear stiffness shall be determined as described above for linear analysis methods. The limiting foundation capacity shall be taken as the factored foundation load capacity, ϕQ_{us} . Parametric variations in analyses shall include: (1) a reduction in stiffness of 50 percent combined with a limiting foundation capacity, ϕQ_{us} , and (2) an increase in stiffness of 50 percent combined with a limiting foundation capacity equal to Q_{us} increased by a factor $1/\phi$.

COMMENTARY

C-A7.2 General Design Requirements

C-A7.2.2 Foundation Load Capacities. In current geotechnical engineering practice, foundation design is based on allowable stresses, with allowable foundation load capacities, Q_{as} , for dead plus live loads based on limiting static settlements and providing a large factor of safety against exceeding ultimate capacities. In current practice, allowable soil stresses for dead plus live loads are increased by one-third for load combinations that include wind or seismic forces. The one-third increase is overly conservative if the allowable stresses for dead plus live loads are far below ultimate soil capacity. This resource paper provides guidance for the direct use of ultimate foundation load capacity, Q_{us} , for load combinations including seismic effects. It is required that foundations be capable of resisting loads with acceptable deformations considering the short duration of seismic loading, the dynamic properties of the soil, and the ultimate load capacities, Q_{us} , of the foundations under vertical, lateral, and rocking loading.

C-A7.2.2.1. Determination of Ultimate Foundation Load Capacities. For competent soils that are not expected to degrade in strength during seismic loading (e.g., due to partial or total liquefaction of cohesionless soils or strength reduction of sensitive clays), use of static soil strengths is recommended for determining ultimate foundation load capacities, Q_{us} . Use of static strengths is somewhat conservative for such soils because rate-of-loading effects tend to increase soil strengths for transient loading. Such rate effects are neglected because they may not result in significant strength increase for some soil types and are difficult to confidently estimate without special dynamic testing programs. The assessment of the potential for soil liquefaction or other mechanisms for reducing soil strengths is critical, because these effects may reduce soil strengths greatly below static strengths in susceptible soils.

The best-estimated ultimate vertical load capacity of footings, Q_{us} , should be determined using accepted foundation engineering practice. In the absence of moment loading, the ultimate vertical load capacity of a rectangular footing of width B and length L may be written as $Q_{us} = q_c BL$ where q_c = ultimate soil bearing pressure.

For rigid footings subject to moment and vertical load, contact stresses become concentrated at footing edges, particularly as footing uplift occurs. The ultimate moment capacity, M_{us} , of the footing as limited by the soil is dependent upon the ratio of the vertical load stress, q , to the ultimate soil bearing pressure q_c . Assuming that contact stresses are proportional to vertical displacements and remain elastic up to q_c , it can be shown that uplift will occur prior to plastic yielding of the soils when q/q_c is less than 0.5. If q/q_c is greater than 0.5, then the soil at the toe will yield prior to uplift. This is illustrated in Figure C-A7.2.2-1. In general the ultimate moment capacity of a rectangular footing may be expressed as:

$$M_{us} = \frac{LP}{2} \left(1 - \frac{q}{q_c} \right)$$

where P = vertical load, $q = P/B$, B = footing width, and L = footing length in direction of rotation.

The ultimate lateral load capacity of a footing may be assumed equal to the sum of the best-estimated ultimate soil passive resistance against the vertical face of the footing plus the best-estimated ultimate soil friction force on the footing base. The determination of ultimate passive resistance should consider the potential contribution of friction on the face of the footing on the passive resistance.

For piles, the best-estimated ultimate vertical load capacity (for both axial compression and axial tensile loading) should be determined using accepted foundation engineering practice. When evaluating axial tensile load capacity, consideration should be given to the capability of pile cap and splice connections to take tensile loads.

The ultimate moment capacity of a pile group should be determined assuming a rigid pile cap, leading to an initial triangular distribution of axial pile loading from applied overturning moments. However, full axial capacity of piles may be mobilized when computing ultimate moment capacity, in a manner analogous to that described for a footing in Figure C-A7.2.2-1. The

ultimate lateral capacity of a pile group may be assumed equal to the best-estimated ultimate passive resistance acting against the edge of the pile cap and the additional passive resistance provided by piles.

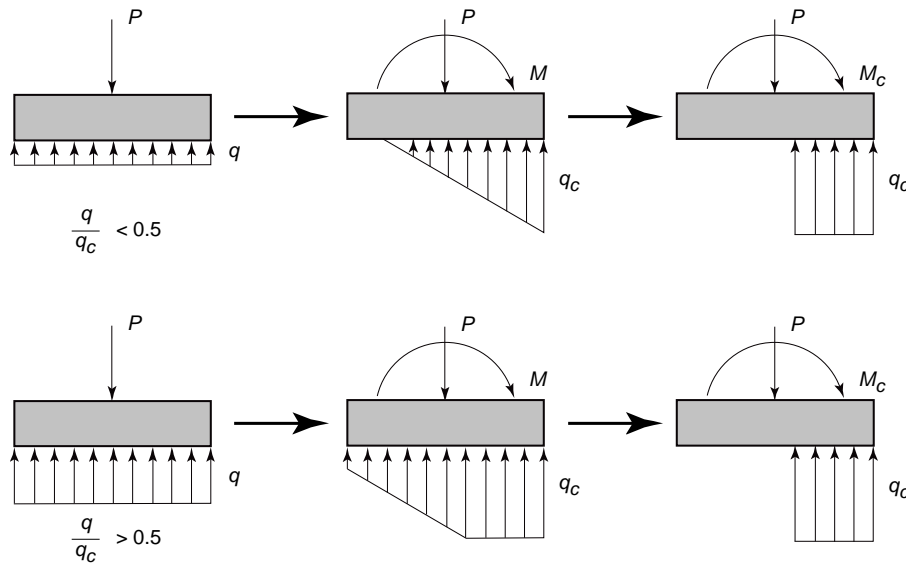

Figure C-A7.2.2-1.

Resistance factors, ϕ , are provided to factor ultimate foundation load capacities, Q_{us} , to reduced capacities, ϕQ_{us} , used to check foundation acceptance criteria. The values of ϕ recommended in the *Provisions* are higher than those recommended in some codes and specifications for long-term static loading. The development of resistance factors for static loading has been based on detailed reliability studies and on calibrations to give designs and factors of safety comparable to those given by allowable stress design. As indicated in the first paragraph of this section, mobilized strengths for seismic loading conditions are expected to be somewhat higher than the static strengths specified for use in obtaining values of Q_{us} , especially for cohesive soils. In the absence of any detailed reliability studies for seismic loading conditions, values of ϕ equal to 0.8 and 0.7 were selected for cohesive and cohesionless soils, respectively, when geotechnical site investigations, including laboratory or in-situ tests, are conducted, and values of ϕ equal to 1.0 and 0.9 were selected when full-scale field tests of prototype foundations are conducted. These values are comparable to the values of 0.8 (for soil strengths determined based on a comprehensive site soil investigation including soil sampling and testing) and 0.9 (for soil strengths determined by site loading testing using plate bearing or near full scale foundation element testing) recommended by the SEAOC Seismology Committee Ad Hoc Foundation Committee (2001).

C-A7.2.2.2 Acceptance Criteria. The factored load capacity, ϕQ_{us} , provides the basis for the acceptance criteria, particularly for the linear analysis procedures. The mobilization of ultimate capacity in the nonlinear analysis procedures does not necessarily mean unacceptable performance as structural deformations due to foundation displacements may be tolerable, as discussed by Martin and Lam (2000). For the nonlinear analysis procedures, it is also prudent to evaluate structural behavior utilizing parametric increases in foundation load capacities above Q_{us} by a factor of $1/\phi$, to check potential changes in structural ductility demands.

C-A7.2.3 Foundation Load-deformation Modeling. Analysis methods described in Section 5.3 (response spectrum procedure) and Section 5.4 (linear response history procedure), permit the use of realistic assumptions for foundation stiffness, as opposed to the assumption of a fixed base. In addition, the nonlinear response history procedure (Section 5.5) and the nonlinear static procedure (Appendix to Chapter 5) permit the use of realistic assumptions for the stiffness and load-carrying characteristics of the foundations. Guidance for flexible foundation (non-fixed base) modeling for the above analysis procedures are described herein.

Foundation load-deformation behavior characterized by stiffness and load capacity may significantly influence the seismic performance of a structure, with respect to both load demands and distribution among structural elements (ATC 1996, NEHRP 1997a, 1997b). This is illustrated schematically in Figure C-A 7.2.3-1. While it is recognized that the load-deformation behavior of foundations is nonlinear, an equivalent elasto-plastic representation of load-deformation behavior is often assumed as illustrated in Figure C-A 7.2.3-2. To allow for variability and uncertainty in the selection of soil parameters

and analysis methods used to determine stiffness and capacity, a range of parameters for foundation modeling should be used to permit sensitivity evaluations.

Foundation stiffness and strength affect various structural components differently.

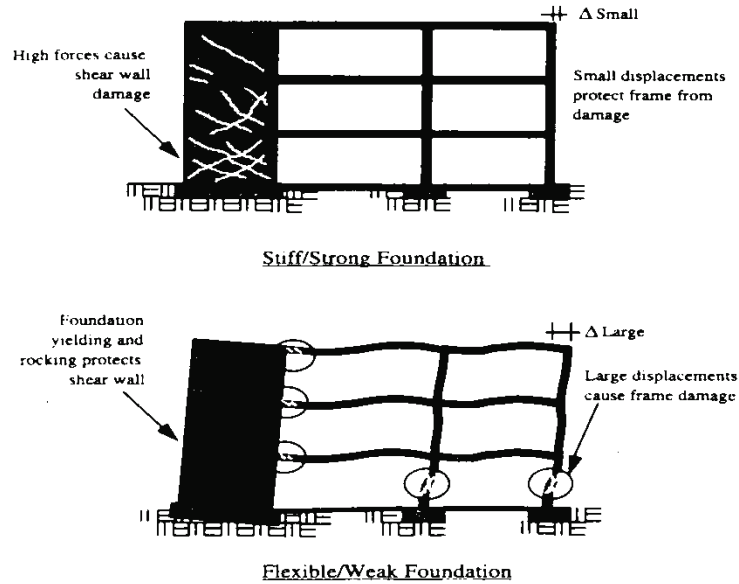

Stiff/strong is not always favorable; nor is flexible/weak always conservative.

Figure C-A7.2.3-1

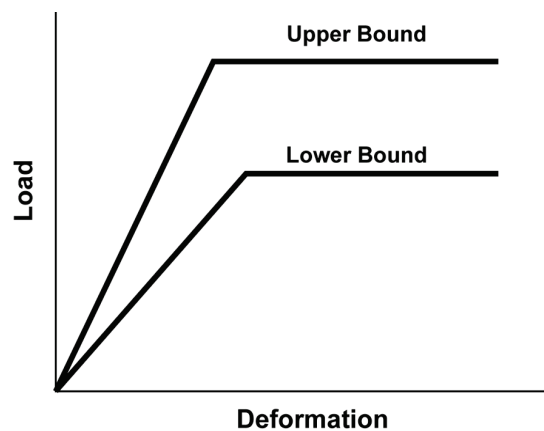

Figure CA7.2.3-2.

Consider the spread footing shown in Figure C-A 7.2.3-3 with an applied vertical load (P), lateral load (H), and moment (M). The soil characteristics might be modeled as two translational springs and a rotational spring, each characterized by a linear elastic-stiffness and a plastic capacity. The use of a Winkler spring model acting in conjunction with the foundation to eliminate the rotational spring may also be used, as shown in Figure C-A7.2.3-4. The Winkler model can capture more

accurately progressive mobilization of plastic capacity during rocking behavior. Note the lateral action is normally uncoupled from the vertical and rotational action. Many foundation systems are relatively stiff and strong in the horizontal direction, due to passive resistance against the face of footings or basement walls, and friction beneath footings and floor slabs. Comparisons of horizontal stiffness of the foundation and the structure can provide guidance on the need to include horizontal foundation stiffness in demand or capacity analyses. In general, foundation rocking has the most influence on structural response. Slender shear wall structures founded on strip footings, in particular, are most sensitive to the effects of foundation rocking.

Assuming a shallow footing foundation may be represented by an embedded rigid plate in an elastic half-space, classical elastic solutions may be used to compute the uncoupled elastic stiffness parameters. Representative solutions are described in *Commentary* to Section 5.6. Solutions developed by Gazetas (1991) are also often used, as described in ATC (1996). Dynamic soil properties (i.e. properties consistent with seismic wave velocities and associated moduli of the soils as opposed to static soil moduli) should be used in dynamic soil solutions. The effects of nonlinearity on dynamic soil properties should be incorporated using the reduction factors in Section 5.6.2.1.1 or based on a site-specific study.

In the case of pile groups, the uncoupled spring model shown in Figure C-A 7.2.3-3 also may be used, when the footing represents the pile cap. In the case of the vertical and rotational springs, it can be assumed that the contribution of the pile cap is relatively small compared to the contribution of the piles. In general, mobilization of passive pressures by either the pile caps or basement walls will control lateral spring stiffness. Hence, estimates of lateral spring stiffness can be computed using elastic solutions as for footings. In instances when piles may contribute significantly to lateral stiffness (i.e., very soft soils, battered piles), solutions using beam-column pile models are recommended.

Axial pile group stiffness spring values, k_{sv} , are generally in the range given by:

$$k_{sv} = \sum_{n=1}^N \frac{0.5AE}{L} \text{ to } \sum_{n=1}^N \frac{2AE}{L}$$

where A = cross-sectional area of a pile, E = modulus of elasticity of piles, L = Length of piles, and N = number of piles in group.

Values of axial stiffness depend on complex nonlinear interaction of the pile and soil (NEHRP, 1997b). For simplicity, best estimate values of AE/L and $1.5 AE/L$ are recommended for piles when axial capacity is primarily controlled by end bearing and side friction, respectively.

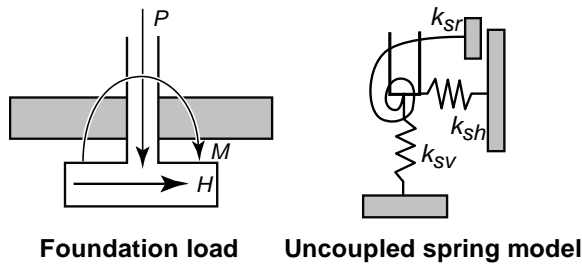

Figure C-A7.2.3-3.

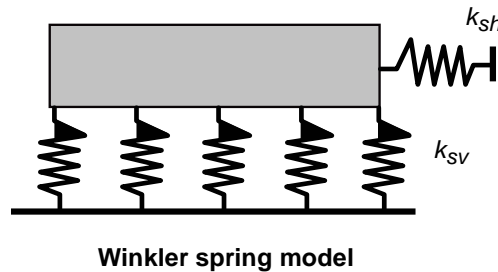

Figure C-A7.2.3-4.

The rocking spring stiffness values, k_{sr} , about each horizontal pile cap axis may be computed by assuming each axial pile spring acts as a discrete Winkler spring. The rotational spring constant (moment per unit rotation) is then given by:

$$k_{sr} = \sum_{n=1}^N k_{vn} S_n^2$$

where k_{vn} = axial stiffness of the n^{th} pile and S_n = distance between n^{th} pile and axis of rotation. The effects of group action and the influence of pile batter are not accounted for in the above equations. These effects should be evaluated if judged significant.

Design Examples. In order to study and illustrate the effects of the change from allowable stress to ultimate strength design of foundations a series of examples were generated. The examples compared the size of foundations resulting from ultimate strength designs (USD) according to the new procedures with those that would be obtained from conventional allowable stress designs (ASD).

The examples were based upon a single six-story reinforced concrete building with shear walls and gravity frame (see Figure 7.2.3-5). One set of examples was for a shallow spread footing design beneath a shear wall. The other set applied to deep cast-in-drilled-hole (CIDH) piers placed beneath the same wall. For each set of examples, individual designs reflected a range of soil strengths and ASD factors of safety. The vertical loads were not changed, but two levels of seismic overturning demand were imposed.

While it is not possible to generalize the results of these examples to apply universally, they are representative of the effects of the change to USD for a realistic case study. For the spread footing foundation the area of the footing for USD compared to that for ASD is controlled by the factor of safety applied to the soil strength for vertical loads. This reduction ranged from 0 to 20 percent for a low FOS (2) up to 25 to 40 percent for a high FOS (4). This is not surprising; when ASD uses a high factor of safety and is thus most conservative, USD results in a smaller footing size. However, the footing size cannot be smaller than that required for allowable stresses for static design under vertical dead plus live loads. For the pier example, the required length for USD was actually about 50 percent greater than for ASD for a low FOS (1.5) and up to 40 percent less for a high FOS (4).

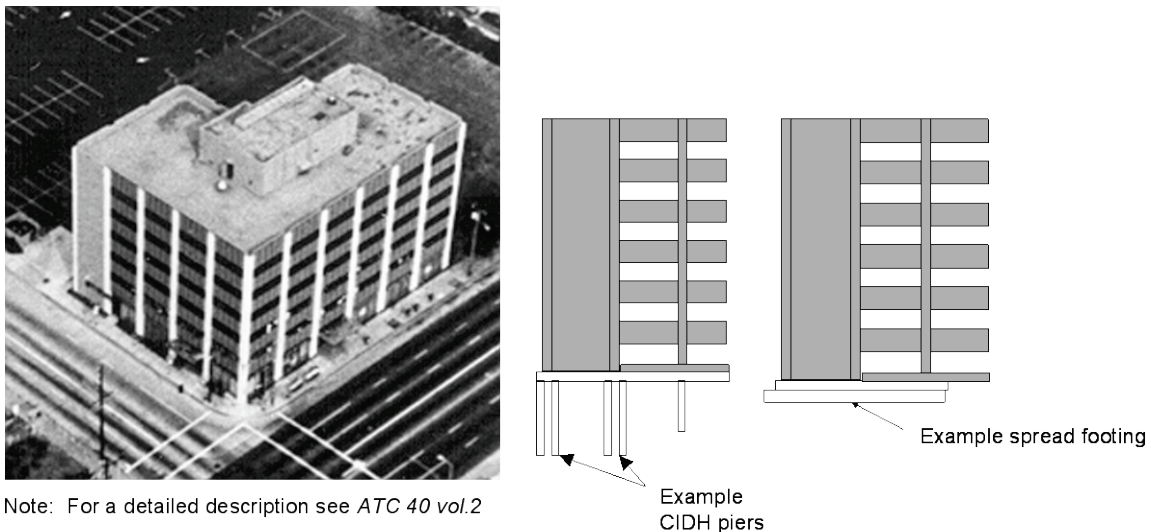

Note: For a detailed description see ATC 40 vol.2

Figure C-A7.2.3-5 Example building.

REFERENCES

- Applied Technology Council. 1996. *Seismic Evaluation and Retrofit of Concrete Buildings*, ATC 40, 2 volumes. Prepared for the Seismic Safety Commission of the State of California. ATC, Redwood City, California.
- Building Seismic Safety Council. 1997a and b. *National Earthquake Hazard Reduction Program Guidelines and Commentary for the Seismic Rehabilitation of Buildings*, FEMA 273 and 274. Federal Emergency Management Agency, Washington, D.C.
- Gazetas, G. 1991. "Foundation Vibrations," *Foundation Engineering Handbook*, 2nd Edition, Van Nostrand Reinhold, Edited by Hsai-Yang Fang.
- Martin, G. R., and I. P. Lam. 2000. "Earthquake Resistant Design of Foundations: Retrofit of Existing Foundations," in *GeoEng 2000*, proceedings of the International Conference on Geological and Geotechnical Engineering, Melbourne, Australia, November.
- Structural Engineers Association of California, Seismology Committee, Ad Hoc Foundations Committee. 2001. "USD/LRFD/Limit State Approach to Foundation Design," in *Proceedings of the 70th Annual SEAOC Convention*, San Diego, California.

Page intentionally left blank.

Resource Paper 5

ALTERNATIVE PROVISIONS FOR THE DESIGN OF PIPING SYSTEMS

(2003 Provisions Appendix to Chapter 6, Architectural, Mechanical, and Electrical Component Design Requirements)

Chapter 6, Architectural, Mechanical, and Electrical Component Design Requirements, of the 2003 NEHRP Recommended Provisions did not recognize discrete levels of performance that may be relevant to the seismic design of piping systems, particularly for essential facilities. This appendix was added to the 2003 Provisions to provide preliminary criteria for the establishment of such performance criteria and their use in the assessment and design of piping systems. The situation has not changed and this appendix and its commentary are reproduced here as a resource for use in the future. Note that only format changes have been made and Provisions section numbers cited refer to the 2003 edition of the Provisions. The performance criteria, from least restrictive to most severe, are: position retention, leak tightness, and operability. In particular, the interaction of systems and interface with the relevant piping design standards is addressed.

PROVISIONS

A6.1 Definitions

Leak Tightness: The condition of a piping system characterized by containment of contents, or maintenance of a vacuum, with no discernable leakage.

Operability: The condition of a piping system characterized by leak tightness as well as continued delivery, shutoff or throttle of pipe contents flow by means of unimpaired operation of equipment and components such as pumps, compressors and valves.

Position Retention: The condition of a piping system characterized by the absence of collapse or fall of any part of the system.

A6.2 Design Approach

The seismic design of piping systems is determined on the basis of Seismic Design Category, I_p , and pipe size, as provided in Table A6.2-1. For each case in Table A6.2-1, the procedure for seismic qualification is specified in Section A.6.5.

When $I_p = 1.0$, the piping system is not critical and is required to maintain position retention.

When $I_p = 1.5$, the piping system is critical and is required to exhibit leak tightness and may be required to maintain operability.

Table A6.2-1 Seismic Design Requirements

Seismic Design Category	$I_p = 1.0$		$I_p = 1.5$	
	Pipe Size \leq 4 inch (SI: 102 mm)	Pipe Size $>$ 4 inch (SI: 102 mm)	Pipe Size \leq 4 inch (SI: 102 mm)	Pipe Size $>$ 4 inch (SI: 102 mm)
B	Interactions (A6.5.2.1)	Interactions (A6.5.2.1)	Bracing (A6.5.2.2) Restraints (A6.5.2.3) Operability ^a (A6.5.2.4) Interactions (A6.5.2.1)	Bracing (A6.5.2.2) Restraints (A6.5.2.3) Operability ^a (A6.5.2.4) Interactions (A6.5.2.1)
C or D	Interactions (A6.5.2.1)	Interactions (A6.5.2.1)	Bracing (A6.5.2.2) Restraints (A6.5.2.3) Operability ^a (A6.5.2.4) Interactions (A6.5.4.2.1)	Analysis (A6.5.2.5) Restraints (A6.5.2.3) Operability ^a (A6.5.2.4) Interactions (A6.5.2.1)
E or F	Bracing (A6.5.2.2) Restraints (A6.5.2.3) Interactions (A6.5.2.1)	Bracing (A6.5.2.2) Restraints (A6.5.2.3) Operability ^a (A6.5.2.4) Interactions (A6.5.2.1)	Analysis (A6.5.2.5) Restraints (A6.5.2.3) Operability ^a (A6.5.2.4) Interactions (A6.5.2.1)	Analysis (A6.5.2.5) Restraints (A6.5.2.3) Operability ^a (A6.5.2.4) Interactions (A6.5.2.1)

^a Leak tightness is the default requirement. Operability applies only when specified by design.

A6.3 System Coefficients

A6.3.1 Deformability. Piping systems shall be classified as either high-, limited-, or low-deformability systems. All materials in high-deformability piping systems shall have an elongation at rupture of at least 10 percent at the operating temperature, and pipes and pipe components used in high-deformability systems shall be joined by welding or by bolted flanges. Systems containing components with an elongation at rupture of less than 10 percent at the operating temperature, or having joints that rely only on friction, shall be classified as low-deformability systems. Systems that are neither high- nor low-deformability systems shall be classified as limited deformability systems. Systems with threaded connections shall be classified as limited- or low-deformability systems.

A6.3.2 Seismic Coefficients. The seismic coefficients a_p and R_p are specified in Table 6.4.1 for high-, limited-, and low-deformability piping systems.

A6.4 Seismic Demand

A6.4.1 Seismic demand on a piping system consists of applied forces and relative displacements.

A6.4.2 Seismic forces shall be determined as specified in Section 6.2.6.

A6.4.3 Seismic relative displacements at points of attachments of pipe restraints to the structure shall be determined as specified in Section 6.2.7.

A6.5 Seismic Qualification

A6.5.1 Elevator system piping shall satisfy the provisions of Section 6.4.9. ASME B31 pressure piping systems shall satisfy the provisions of the applicable ASME B31 code section. Fire sprinkler systems shall satisfy the provisions of Section A6.5.2.6.

A6.5.2 The seismic qualification of piping systems depends on the Design Approach selected in Section A6.2.

A6.5.2.1 When interactions are specified they shall be evaluated in accordance with Section 6.2.3.

A6.5.2.2 When bracing is specified, the pipe must be seismically restrained. Lateral restraints shall be provided (a) to limit the bending stress in the pipe to yield at the operating temperature and (b) to limit the rotations at articulated joints within the manufacturer limits. Unlike analysis (Section A6.5.2.5), bracing does not require a detailed analysis of the piping system; the distance between seismic restraints may be established based on beam approximations of the pipe spans. The effect of seismic restraints on operating loads (thermal expansion and contraction and weight) shall be considered.

A6.5.2.3 When restraints are specified, the pipe seismic restraints as well as their welds and anchorage attachment to the structure shall comply with the provisions of Chapters 8 to 12 of the 2003 *Provisions*. Supports shall be constructed so that support engagement is maintained considering both lateral and vertical seismic forces.

A6.5.2.4 When operability is specified, the equipment and components that must perform an active function that involves moving parts (such as pumps, compressors, fans and valve operators) shall comply with the requirements of Section 2.4.5.

A6.5.2.5 When analysis is specified, the piping system shall be analyzed by static or dynamic methods. The maximum calculated elastic stress due to the earthquake loads and concurrent weight and pressure shall be limited to $1.5S_Y$ (where S_Y is the minimum specified material yield stress at normal operating temperature) and the rotations at articulated joints shall be within the manufacturer limits. The analysis shall include the effects of stress intensification factors as determined in the ASME B31 pressure piping code, and corrosion effects.

A6.5.2.6 Fire protection sprinkler systems shall meet the following requirements:

A6.5.2.6.1 Fire protection sprinkler systems in Seismic Design Categories A, B and C designed and constructed in accordance with NFPA-13 shall be deemed to satisfy the seismic force and relative displacement requirements of these *Provisions*.

A6.5.2.6.2 In Seismic Design Categories D, E and F, fire protection sprinkler systems designed and constructed in accordance with NFPA 13 shall also meet the following additional criteria:

1. The spacing of longitudinal sway bracing and transverse sway bracing specified in NFPA 13 Section 9.3.5 shall be reduced by multiplying the maximum brace spacing permitted in NFPA 13 Section 9.3.5 by $0.8W_p/F_p$.
2. The value of $0.8W_p/F_p$ shall not be taken as greater than 1.0.

COMMENTARY

C-A6.1 Seismic Interaction. There are two types of seismic interactions: system interactions and spatial interactions. A system interaction is a spurious or erroneous signal resulting in unanticipated operating conditions, such as the spurious start-up of a pump motor or the unintended closure of a valve. Spatial interactions are interactions caused by the failure of a structure or component in close proximity. Spatial interactions can in turn be further divided into falling interactions, swing interactions, and spray interactions. A falling interaction is an impact on a critical component due to the fall of overhead or adjacent equipment or structure. A swing interaction is an impact due to the swing or rocking of adjacent component or suspended system. A spray interaction is due to the leakage of overhead or adjacent piping or vessels.

Any interaction involves two components, a source, and a target. An interaction source is the component or structure that could fail and interact with the seismically designed component. An interaction target is a seismically qualified component that is being impacted, sprayed or spuriously activated. For an interaction to affect a seismically qualified component, it must be credible and significant. A credible interaction is one that can take place. For example, the fall of a ceiling panel located overhead from a motor control center is a credible interaction because the falling panel can reach and impact the motor control center. The target (the MCC) is said to be within the zone of influence of the source (the ceiling panel). A significant interaction is one that can result in damage to the target. For example, the fall of a light fixture on a 20-inch steel pipe may be credible (the light fixture being above the pipe) but may not be significant (the light fixture will not damage the steel pipe). In contrast, the overturning of a rack on an instrument panel is a significant interaction.

The process of considering seismic interactions begins with a interaction review. For new structures, this involves examination of the design drawings, to identify the interaction targets, and credible and significant sources of interaction. In many cases, the design documents may only locate components and systems in schematic terms. The actual location of, for example, piping and ductwork systems is determined in the field. In this case and when work is being performed on an existing structure, it is necessary to begin the interaction review with a walk-down, typically with a photographic record. Based on the assembled data, supporting calculations to document credible and significant sources of interactions can be prepared.

In practice, it is only necessary to document credible and significant sources of interaction. It is not necessary to list and evaluate every single overhead or adjacent component in the area around the target, only those that could interact and whose interaction could damage the target. Because only credible and significant sources of interaction are documented, an important aspect of the interaction review is engineering judgment. The spatial interaction review should therefore be performed by experienced seismic design engineers.

When system interactions are of importance, the written input of a system engineer is in order.

Page intentionally left blank.

Resource Paper 6

OTHER NONBUILDING STRUCTURES

(2003 Provisions Appendix to Chapter 14, Nonbuilding Structure Design Requirements)

This appendix first appeared in the 2000 NEHRP Recommended Seismic Provisions and was revised for inclusion in the 2003 Provisions. It is intended to serve as a resource document for future voluntary standards and model code development and to encourage development of up-to-date consensus standards for electrical transmission, substation, and distribution structures, telecommunications towers, and buried structures as well as performance criteria for tanks and vessels. The guidance presented reflects current industry design practice for these types of nonbuilding structures. Feedback will be appreciated. Note that only format changes have been made and Provisions section numbers cited refer to the 2003 edition of the Provisions.

PROVISIONS

A14.1 General

A14.1.1 Scope. This paper includes design requirements for electrical transmission, substation, and distribution structures, telecommunications towers, and buried structures and performance criteria for tanks and vessels.

A14.1.2 References

IEEE 693 Institute of Electrical and Electronics Engineers, *Recommended Practices for Seismic Design of Substations*, Power Engineering Society, Piscataway, New Jersey, 1997.

A14.1.3 Definitions

Base shear: See Section 4.1.3.

Buried structures: Subgrade structures such as tanks, tunnels, and pipes.

Dead load: See Section 4.1.3.

Registered design professional: See Section 2.1.3.

Seismic Use Group: See Section 1.1.4.

Structure: See Section 1.1.4.

A14.1.4 Notation

C_d See Section 4.1.4.

C_S See Section 5.1.3.

I See Section 1.1.5.

R See Section 4.1.4.

S_{DI} See Section 3.1.4.

S_{DS} See Section 3.1.4.

T See Section 4.1.4.

V See Section 5.1.3.

W See Section 1.1.5.

Ω_0 See Section 4.1.4.

A14.2 Design Requirements

A14.2.1 Buried Structures. Buried structures that are assigned to Seismic Use Group II or III, or warrant special seismic design as determined by the registered design professional, shall be identified in the geotechnical report. Such buried structures shall be designed to resist minimum seismic lateral forces and expected differential displacements determined from a properly substantiated analysis using approved procedures.

A14.3 Performance Criteria for Tanks and Vessels

Tanks and vessels shall be designed to meet the minimum post-earthquake performance criteria as specified in Table A14.3-1. These criteria depend on the Seismic Use Group and content-related hazards of the tanks and vessels being considered.

Table A14.3-1 Performance Criteria for Tanks and Vessels

Performance Category ^a	Minimum Post-earthquake Performance
I	The structure shall be permitted to fail if the resulting spill does not pose a threat to the public or to adjoining Category I, II or III structures.
II	The structure shall be permitted to sustain localized damage, including minor leaks, if (a) such damage remains localized and does not propagate; and (b) the resulting leakage does not pose a threat to the public or to adjoining Category I, II or III structures.
III	The structure shall be permitted to sustain minor damage, and its operational systems or components (valves and controls) shall be permitted to become inoperative, if (a) the structure retains its ability to contain 100 percent of its contents; and (b) the damage is not accompanied by and does not lead to leakage.
IV ^b	The structure shall be permitted to sustain minor damage provided that (a) it shall retain its ability to contain 100 percent of its contents without leakage; and (b) its operational systems or components shall remain fully operational.

^aPerformance Categories I, II, and III correspond to the Seismic Use Groups defined in Section 1.2 and tabulated in Table 14.2-1.

^bFor tanks and vessels in Performance Category IV, an Importance Factor, *I*, of 1.0 shall be used.

COMMENTARY

C-A14.1 General

C-A14.2.1 Buried Structures. This section is included for the following reasons:

1. The material may serve as a starting point for continued development.
2. The comments stimulated by consideration of this section will provide valuable input so that this section may be further developed and then incorporated in the *Provisions* in the future.
3. It was determined by TS 13 and the Provisions Update Committee that it would be premature to incorporate this section into the *Provisions* for the 2000 edition.
4. Accepted industry standards are in the process of incorporating seismic design methodology reflecting the *Provisions*.

It is not the intent of the Provisions Update Committee to discourage incorporation of this section into a building code or to minimize the importance of this section. Placing this section in the appendix indicates only that this section requires further development.

Seismic forces on buried structures may include forces due to: soil displacement, seismic lateral earth pressure, buoyant forces related to liquefaction, permanent ground displacements from slope instability, lateral spread movement, fault movement, or dynamic ground displacement caused by dynamic strains from wave propagation. Identification of appropriate seismic loading conditions is dependent upon subsurface soil conditions and the configuration of the buried structure. Conditions related to permanent ground movement can often be avoided by careful site selection for isolated buried structures such as tanks and vaults. Relocation is often impractical for long buried structures such as tunnels and pipelines.

Wave propagation strains are a significant seismic force condition for buried structures if local site conditions (for instance, deep surface soil deposits with low shear wave velocities) can support the propagation of large amplitude seismic waves. Wave propagation strains tend to be most pronounced at the junctions of dissimilar buried structures (such as a pipeline connecting with a building) or at the interfaces of different geologic materials (such as a pipeline passing from rock to soft soil).

Loading conditions related to liquefaction require detailed subsurface information that can be used to assess the potential for liquefaction and, for long buried structures, the length of structure exposed to liquefaction effects. In addition, the assessment of liquefaction requires specifying an earthquake magnitude that is consistent with the definition of ground shaking. It is recommended that one refer to Chapter 7 of this *Commentary* for additional guidance in determining liquefaction potential and seismic magnitude. Providing detailed structural design procedures in this area is beyond the scope of this document.

Loading conditions related to lateral spread movement and slope instability can be defined in terms of lateral soil pressures or prescribed ground displacements. In both cases, sufficient subsurface investigation in the vicinity of the buried structure is necessary to estimate the amount of movement, the direction of movement relative to the buried structure, and the portion of the buried structure exposed to the loading conditions. Definition of lateral spread loading conditions requires special geotechnical expertise and specific procedures in this area are beyond the scope of this document.

Defining the loading conditions for fault movement requires specific location of the fault and an estimate of the earthquake magnitude on the fault that is consistent with the ground shaking hazard in the *Provisions*. Identification of the fault location should be based on past earthquake movements, trenching studies, information from boring logs, or other accepted fault identification techniques. Defining fault movement conditions requires special seismological expertise. Additional guidance can be found in the Chapter 7 *Commentary*.

It may not be practically feasible to design a buried structure to resist the effects of permanent ground deformation. Alternative approaches in such cases may include relocation to avoid the condition, ground improvements to reduce the loads, or implementing special procedures or design features to minimize the impact of damage (such as remote controlled or automatic isolation valves that provide the ability to rapidly bypass damage or post-earthquake procedures to expedite repair). The goal of providing procedures or design features as an alternative to designing for the seismic loadings is to change the hazard and function classification of the buried structure such that it is not classified as Seismic Use Group II or III.

It is recommended that one refer to the Chapter 7 *Commentary* for additional guidance in determining liquefaction potential and determining seismic magnitude.

Buried structures are subgrade structures such as tanks, tunnels, and pipes. Buried structures that are designated as Seismic Use Group II or III, or are of such a size or length to warrant special seismic design as determined by the registered design professional, must be identified in the geotechnical report.

Buried structures must be designed to resist minimum seismic lateral forces determined from a substantiated analysis using approved procedures. Flexible couplings must be provided for buried structures requiring special seismic considerations when changes in the support system, configuration, or soil condition occur.

The requirement for and value of flexible couplings should be determined by the “properly substantiated analysis and approved procedures.” It is assumed that the need for flexible couplings refers to buried piping or conduits. The prior wording of Section A14.2.3 was far too broad in requiring flexible couplings when changes in the support system, configuration or soil condition occur. These broad requirements could result in flexible couplings installed at locations where permanent ground displacement is expected or at transitions between aboveground supported pipe and buried pipe. As currently available flexible couplings are not generally designed to match the ultimate strength properties of the piping or conduit, the prior requirements potentially introduce a weak point in the piping or conduit system. The original focus of the prior requirements was penetrations of buried service lines into a building or other structure. Properly designed flexible couplings can be an effective means to limit forces at connections to buried structures. However, special care is needed to make sure the design loads and displacements are adequately specified. There are several other alternative to providing sufficient flexibility at connections to buried structures that are more robust in terms of margin above their design levels.

REFERENCES

- Agrawal, P. K., and J. M. Kramer. 1976. “Analysis of Transmission Structures and Substation Structures and Equipment for Seismic Loading,” Sargent and Lundy Transmission and Substation Conference, December 2, 1976.
- American Society of Civil Engineers (ASCE). 1997. *Design of Latticed Transmission Structures*, ANSI/ASCE/SEI 10.
- ASCE. 1991. *Tubular Pole Design Standard*, ASCE/SEI Manual 72.
- ASCE. 2000. *Guidelines for Electrical Transmission Line Structural Loading*, ASCE/SEI Manual 74.
- ASCE. 1995. *Minimum Design Loads for Buildings and Other Structures*, ASCE/SEI 7.
- ASCE. 1997. *The Design of Guyed Electrical Transmission Structures*, ASCE/SEI Manual 91.
- ASCE. 2000. *Substation Structure Design Guide*.
- Li, H.-N., S. Wang, M. Lu, and Q. Wang. 1991. “Aseismic Calculations for Transmission Towers,” in *ASCE/SEI Technical Council on Lifeline Earthquake Engineering, Monograph No. 4*, August 1991.

- Steinhardt, O. W. 1981. "Low Cost Seismic Strengthening of Power Systems," *Journal of The Technical Councils of ASCE*, April.
- Amiri, G. G., and G. G. McClure. 1996. "Seismic Response to Tall Guyed Telecommunication Towers," Paper 1982, in *Proceedings of the Eleventh World Conference on Earthquake Engineering*. Elsevier Science Ltd.
- Australian Standards Association. 1994. *Standard Design of Steel Lattice Towers and Masts*, AS 3995.
- Canadian Standards Association. 1994. *Antennas, Towers, and Masts*.
- Li, H.-N., L. E. Suarez, and M. P. Singh. 1994. "Seismic Effects on High-Voltage Transmission Tower and Cable Systems," Fifth U.S. National Conference on Earthquake Engineering.
- Federal Emergency Management Agency. 1990. *Earthquake Resistant Construction of Electric Transmission and Telecommunication Facilities Serving the Federal Government*, FEMA 202..
- Galvez, C. A., and G. G. McClure. 1995. "A Simplified Method for Aseismic Design of Self-Supporting Latticed Telecommunication Towers," Seventh Canadian Conference on Earthquake Engineering, Montreal.
- Institute of Electrical and Electronics Engineers (IEEE). 1997. *National Electrical Safety Code*, ANSI C2.
- IEEE. 1997. *Recommended Practices for Seismic Design of Substations*. IEEE 693. Power Engineering Society, Piscataway, New Jersey.
- IEEE. 1991. *Trial-Use Design Guide for Wood Transmission Structures*, IEEE 751. Power Engineering Society, Piscataway, New Jersey.
- Long, L.W. 1973. Analysis of Seismic Effects on Transmission Structures, IEEE Paper T 73 326-6.
- Lum, W. B., N. N. Nielson, R. Koyanagi, and A. N. L. Chui. 1984. "Damage Survey of the Kasiki, Hawaii Earthquake of November 16, 1993," *Earthquake Spectra*, November.
- Lyver, T. D., W. H. Mueller, and L. Kempner, Jr. 1996. *Response Modification Factor, R_w , for Transmission Towers*. Portland State University, Portland, Oregon.
- National Center for Earthquake Engineering Research. 1995. *The Hanshin-Awaji Earthquake of January 17, 1995 Performance of Lifelines*, Technical Report NCEER-95-0015. State University of New York at Buffalo.
- Rural Electrical Administration (REA). 1992. *Design Manual for High Voltage Transmission Lines*, Bulletin 1724E-200.
- REA. 1978. *Design Guide for Rural Substations*, Bulletin 65-1.
- REA. 1982. *Mechanical Design Manual for Overhead Distribution Lines*, Bulletin 160-2.
- Telecommunications Industry Association (TIA). 1996. *Structural Standards for Steel Antenna Towers and Antenna Supporting Structures*, TIA/EIA 222F.

Resource Paper 7

SPECIAL REQUIREMENTS FOR SEISMIC DESIGN OF STRUCTURAL GLUED LAMINATED TIMBER (Glulam) ARCH MEMBERS AND THEIR CONNECTIONS IN THREE-HINGE ARCH SYSTEMS

Glulam arch structures are used with some regularity in churches and other public buildings and assembly areas; however, ASCE/SEI 7-05 does not provide guidance regarding the seismic design of these systems. The design recommendations reflected in this resource paper were drafted by BSSC Technical Subcommittee 7, Design of Wood, with input from the American Institute of Timber Construction (AITC). This paper provides seismic design coefficients for two classes of one-story three-hinge arch systems: a special glulam arch and a glulam arch not specifically detailed for seismic resistance.

For special glulam arch systems, required detailing enables limited inelastic behavior in connections through either wood bearing or fastener yielding. This is accomplished by requiring design of wood members at connections for the lesser of overstrength forces or the forces that can be developed in the connections. Use of glulam arch systems not specifically detailed for seismic resistance is limited to Seismic Design Categories A, B, and C. This limit is analogous to the approach taken for steel systems not specifically detailed for seismic resistance and wood shear wall systems with other than wood structural panel. The value of $R = 2.0$ is based on a relative comparison of R for special systems. The assumed system overstrength for both systems is $\Omega_0=2.5$.

To facilitate eventual code/standard adoption of the guidance provided in this paper, requirements are presented first followed by a commentary section.

PROPOSED REQUIREMENTS FOR ONE-STORY THREE-HINGE ARCH SYSTEMS

1. Scope. These provisions are intended for use in the design and detailing of structural glued laminated timber (glulam) arch members and connections that are part of the seismic-force-resisting system in one-story three-hinge arch systems. Seismic design coefficients for these systems shall be as specified in the applicable building code or, in the absence of such information, shall be as indicated in Table 1.

Glulam arch systems not specifically detailed for seismic resistance shall comply with recommended detailing in AITC 104-2003, *Typical Construction Details* and the requirements of the 2005 *National Design Specification® for Wood Construction (NDS®)* including Appendix E, ASCE/SEI 7-05, *Minimum Design Loads for Buildings and Other Structures* and the applicable building code.

Special glulam arch systems shall meet the requirements for glulam arch systems not specifically designed for seismic resistance. In addition, special glulam arch systems shall meet the requirements of Sections 1.1 through 1.7 below.

Table 1 Seismic Design Coefficients for One-Story Glulam Arch Systems

Seismic-Force-Resisting System	R	Ω_0	C_d
Special glulam arch	2.5	2.5	2.5
Glulam arch not specifically detailed for seismic resistance ^a	2.0	2.5	2.0

^a Limited to Seismic Design Categories A, B, and C only.

1.1 Connection Requirements. Connections that are part of the special glulam arch seismic-force-resisting system shall be in accordance with requirements of NDS Chapter 10 for mechanical connections and the additional requirements of this section.

1.1.1 Arch Base. Arch base connections shall utilize a steel shoe assembly in accordance with AITC 104. Timber rivets or dowel-type fasteners such as thru-bolts or lag screws shall attach the arch to the shoe. Dowel-type fasteners shall be chosen such that the expected yield mode is Mode III or Mode IV as defined in the NDS. Timber rivet connections shall be designed to ensure that the expected strength limit state is characterized by rivet capacity.

1.1.2 Arch Peak. Connection of the arch at the peak shall utilize shear plates, bolts, steel dowels, or metal side plates or combination thereof in accordance with AITC 104.

1.2 Nominal Connection Capacity. The nominal capacity of a connection shall be determined in accordance with the following:

1. For dowel type fasteners -- $n \times Z(K_F)(\lambda)(C_M)(C_t)(C_{eg})$ where n is the number of fasteners; Z is the reference lateral design value for a single fastener; and K_F , λ , C_M , C_t , and C_{eg} are adjustment factors specified in the NDS for format conversion, time effect, wet service, temperature and end grain, respectively.
2. For timber rivets: $(P_r \text{ or } Q_r) \times (K_F)(\lambda)(C_M)(C_t)(C_{st})$ where P_r is parallel to grain reference rivet capacity; Q_r is perpendicular to grain reference rivet capacity; and K_F , λ , C_M , C_t , and C_{st} are adjustment factors specified in the NDS for format conversion, time effect, wet service, temperature and metal side plate, respectively.
3. For split ring and shear plate connectors -- $n \times P \times (K_F)(\lambda)(C_M)(C_t)(C_d)(C_{st})$ or $n \times Q \times (K_F)(\lambda)(C_M)(C_t)(C_d)$ where n is the number of fasteners; P is the reference design value parallel to the grain for a single split ring connector unit or shear plate unit; Q is the reference design value perpendicular to grain for a single split ring connector unit or shear plate unit; and K_F , λ , C_M , C_t , C_d , and C_{st} are adjustment factors specified in the NDS for format conversion, time effect, wet service, temperature, penetration and metal side plate, respectively.

1.3 Member Requirements. Arch members that are part of the special glulam arch seismic-force-resisting system shall meet requirements of the NDS and the requirements of this section.

1.3.1 Slenderness. The ratio of tangent point depth to breadth (d_t/b) shall not exceed 6 based on actual dimensions when one edge of the arch is braced by decking fastened directly to the arch or braced at frequent intervals as by girts or roof purlins. When such lateral bracing is not present, d_t/b shall not exceed 5.

1.3.2 End Grain Bearing. At the arch base, end grain bearing shall be on a metal plate with sufficient strength and stiffness to distribute the applied load. At moment splices, end grain bearing shall be on a metal plate when $f_c > (0.75)(F_c^*)$ as required in accordance with NDS Section 3.10.1.3.

1.3.3 Compression Perpendicular to Grain. Compression perpendicular to grain induced at the arch base shall be by a metal plate with sufficient strength and stiffness to distribute the applied load.

1.4 Member Resistance.

1.4.1 Moment, Tension, Compression, and Shear. The arch member for special glulam arch systems shall be designed to resist moment, tension, compression, shear, and applicable combinations of these induced by seismic forces determined in accordance with the load combinations of ASCE/SEI 7-05 Section 12.4.3.2 (load combinations with overstrength) but need not exceed forces resulting from strength at connections determined in accordance with Section 1.4.2a.

1.4.2 Member Resistance at Connections. The arch member for special glulam arch systems shall be designed for limit states of net section tension rupture, row tear-out, group tear-out as defined in NDS Appendix E, and shear in accordance with NDS Section 3.4.3.3 due to the seismic forces as determined by the lesser of:

1. The nominal connection capacity determined in accordance with Section 1.2 for load resistance factor design (LRFD) or the nominal connection capacity determined in accordance with Section 1.2 divided by 1.35 for allowable stress design (ASD).
2. The required capacity resulting from load combinations of ASCE/SEI 7-05 Section 12.4.3.2 (load combinations with overstrength).

1.5 Transfer of Forces to the Arch Members. The diaphragm, members, and connections shall be sized to transfer out-of-plane wall and roof forces into the arch.

1.6 End Fixity. In accordance with assumed pinned behavior of a three-hinge arch, determination of reaction and arch member forces is based on assumed idealized pin behavior at the arch peak and base. Actual detailing may introduce partial moment fixity at reactions, and consideration shall be given to the effect of such fixity on member and connection response.

1.7 Arch Moment Splice. Arch moment splices shall utilize a metal bearing plate (when required), metal side plates, shear plates, bolts, steel dowels, timber rivets, or combination thereof in accordance with AITC 104. Design forces for determining the size and number of fasteners shall be based on load combinations of ASCE/SEI 7-05 Section 12.4.3.2 (load combinations with overstrength) but need not exceed the member design force based on forces resulting from strength at connections (see Section 1.4.1 and 1.4.2a).

COMMENTARY FOR ONE-STORY THREE-HINGE ARCH SYSTEMS

C1 Scope. Special provisions are provided for the design of arch members and connections to resist seismic forces as part of a three-hinge arch system (see Figure C1.0). Such systems typically employ glued laminated timber Tudor arch members and are commonly used in church construction and other facilities intended for public assembly. Common features of these systems are the presence of 2x and 3x tongue and groove roof decking with wood structural panel overlay, longitudinal and transverse walls of light frame construction, or longitudinal and transverse masonry walls. Transverse end walls may or may not be designed as shear walls.

Special requirements apply to typical construction details used for over 50 years in three-hinged arch systems as outlined in AITC 104, *Typical Construction Details*. Typical arch base details in AITC 104 are generally expected to produce good performance characteristics of connection yielding by either wood bearing or a combination of wood bearing and fastener yielding and will limit occurrence strength limit states of row tear-out, group tear-out, and net section tension rupture prior to connection yielding. The design requirements in this white paper utilize standard details that have been used successfully and that encourages a combination of wood bearing and metal fastener yielding modes at the base.

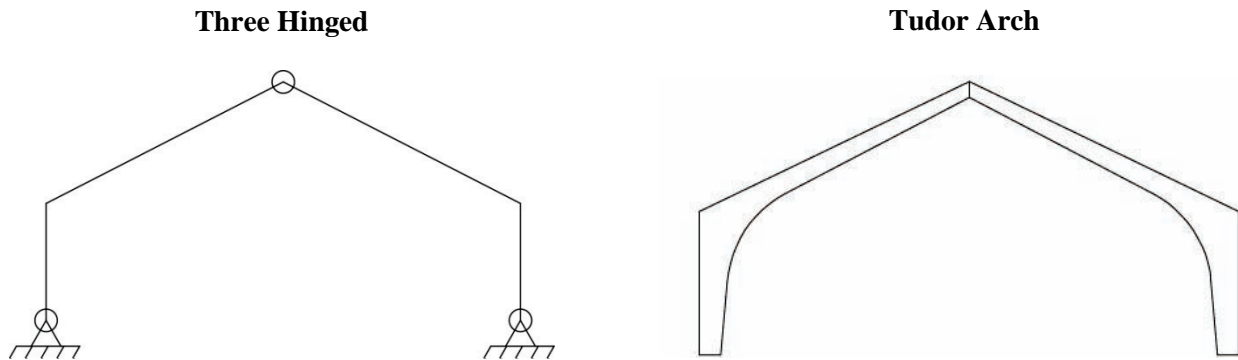

Figure C1.0 Three-hinge arch and Tudor arch configurations.

C1.1 Connection Requirements for Special Glulam Arch Systems. The ordinary load combinations (load combinations without overstrength) of ASCE/SEI 7-05 are used to determine the size and number of fasteners in arch member connections at the base. Determination of the size and number of fasteners is not subject to special load combinations (load combinations with overstrength forces) to enable limited inelastic behavior of dowel-type fasteners (either by wood bearing or fastener bending) when coupled with the wood member strength requirements of Section 1.4. This approach recognizes that wood connection strength is typically governed by wood failure mechanisms, not failure of the metal fasteners. For a given wood member cross-section, determination of the size and number of fasteners based on the overstrength load combinations may not be beneficial to overall connection performance due to an increased number of fasteners and a reduction in wood member net section to accommodate the fasteners.

C1.1.1 Arch Base. The connection at the arch base utilizes a metal shoe (see Figure C1.1.1) and typically employs a thru-bolt loaded in double shear. Placement of the bolt(s) is an important consideration. In-service drying of the member causes shrinkage which must be accounted for in the detailing of the connection to prevent splitting due to the development of tension perpendicular to grain stresses.

It is recommended that the bolt(s) be placed within 6 inches of the back of the arch if standard size holes are used. Where bolt(s) are placed farther than this from the back of the arch to resist the required loads, the designer should provide detailing to allow the wood to shrink without pulling away from the bearing seat. This may be accomplished through the use of slotted holes or oversized holes in the arch member. It is recognized that some movement of the arch at the base will occur before the bolt is engaged. This practice is used to prevent wood splitting due to occurrence of dimensional change under gravity loads. In some situations a bearing seat is also used at the inside face of the arch. In such a case, the bolt(s) is generally placed at the geometric center of the section with the hole(s) detailed to accommodate shrinkage.

Timber rivets as well as lag screws installed at each side of the arch base are expected to produce comparable performance provided that the controlling yield mechanism is based on dowel yielding or rivet capacity.

Under outward loads, the bending yield capacity of the plate at the back of the metal shoe will typically determine the size of the bearing area (i.e., the plate will yield before the wood reaches its design compression perpendicular to grain stress).

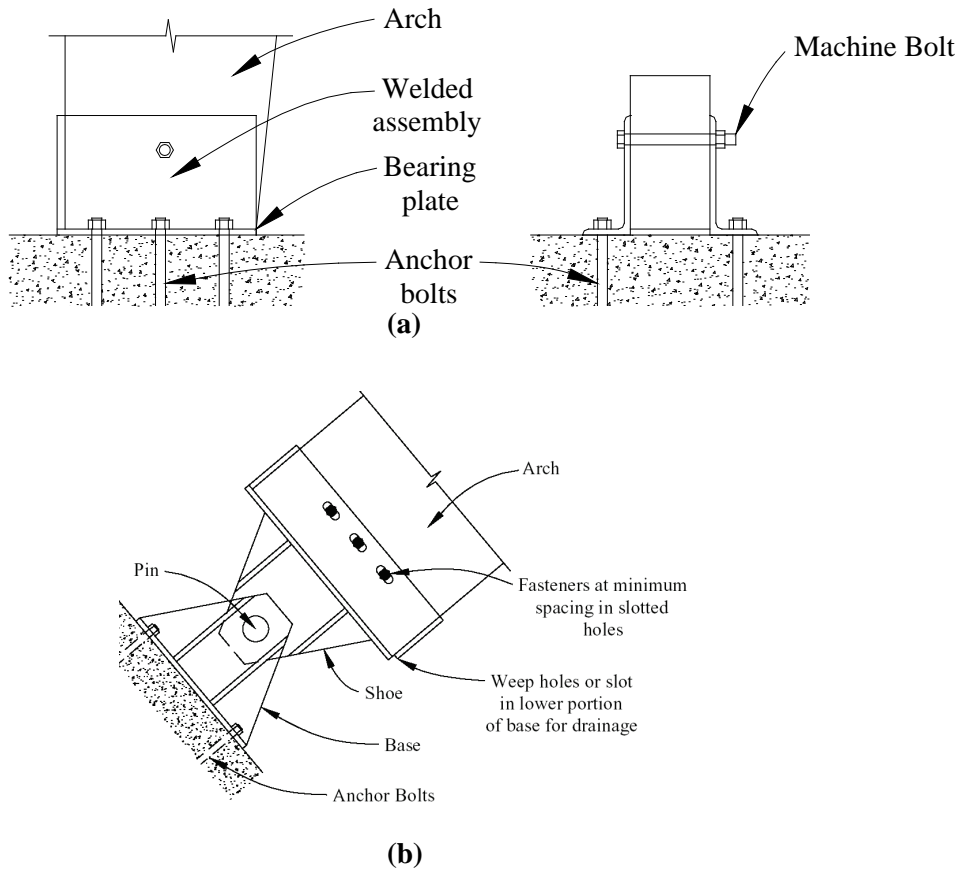

Figure C1.1.1 (a) Typical arch base with thru-bolt and (b) arch base with true hinge.

C1.1.2 Arch Peak. The connection at the peak typically employs use of a shear plate or plates with thru-bolt(s) and is typically pre-fabricated in a manufacturing facility to establish proper fit and alignment. For arches with slopes of 3:12 or more, typical connections employ shear plates and bolts or a combination of shear plates and bolts and dowels to transfer both horizontal and vertical forces. For low pitch (low slope) arches, steel side plates on each face are used in combination with shear plates. Figure C1.1.2 shows one example of a peak connection.

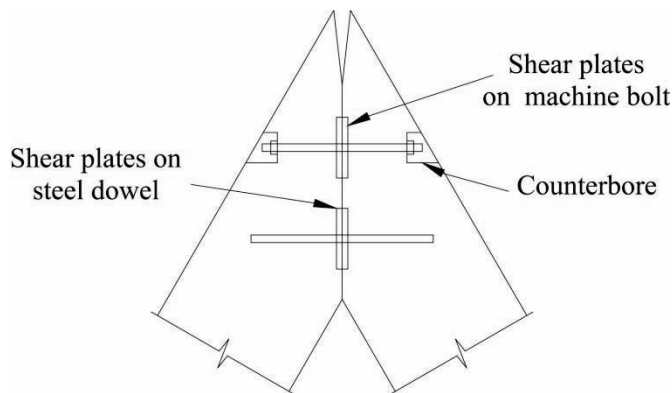

Figure C1.1.2 Typical arch peak connection detail.

The bevel cuts shown at the top of the arch peak connection are used to minimize wood crushing and permit rotation due to downward deflection of the peak connection of deep members. They are not required for all designs but should be considered by the designer where significant rotation is expected. Bevel cuts generally are not used on the bottom side of the connection.

C1.2 Nominal Connection Capacity. Determination of nominal capacity does not include adjustment factors for group action and geometry to more conservatively estimate nominal connection capacity. These factors are 1.0 or less in value and address wood strength limit states that are to be checked explicitly per Appendix E and the shear provisions of the NDS.

C1.3 Member Requirements. Prescriptive limits on d/b match those in the NDS for arches.

C1.3.2 End Grain Bearing. Consistent with typical construction details used for these systems, a metal plate with sufficient strength and stiffness to distribute the applied load is used at the base (see Figure C1.1.1) regardless of the level of stress in end grain bearing. This bearing plate also prevents direct contact between the arch and the concrete, thus preventing moisture from wicking into the arch from the concrete.

C1.3.3 Compression Perpendicular to Grain. Compression stress perpendicular to the grain in the arch member at the base should be through bearing on a metal plate with sufficient strength and stiffness to distribute the applied load.

C1.4 Member Resistance. The requirements of Section 1.4 are intended provide excess capacity in the member relative to connections because little or no inelastic deformation is expected from the arch member itself except in bearing modes. Limited inelastic deformation can occur through wood bearing and fastener yielding in the connection region at the base (see Figure C1.3.3a and b for examples of Mode III and Mode IV yielding and Figure C1.3.3c for cyclic behavior of a bolted steel side plate to wood connection).

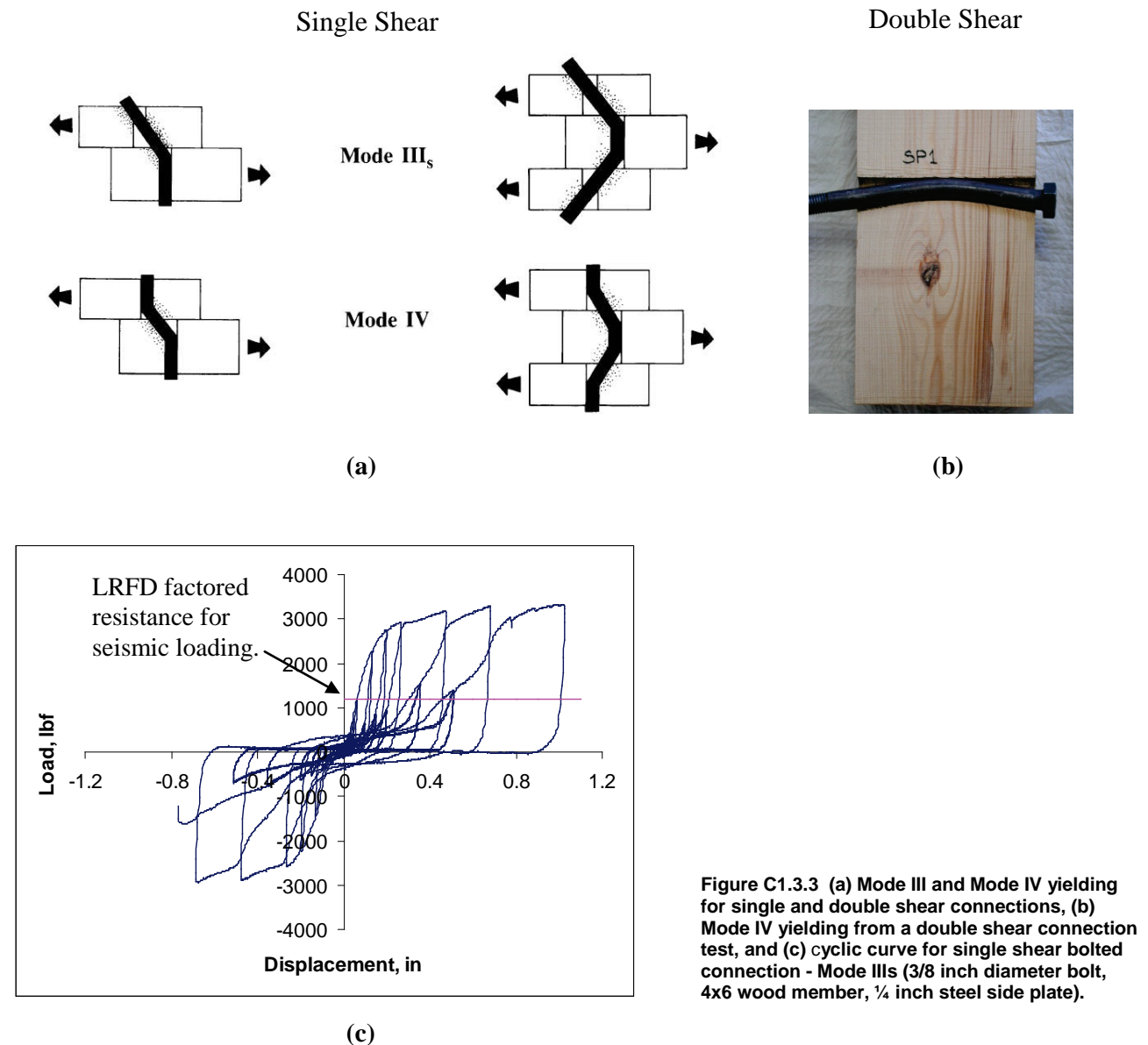

Figure C1.3.3 (a) Mode III and Mode IV yielding for single and double shear connections, (b) Mode IV yielding from a double shear connection test, and (c) cyclic curve for single shear bolted connection - Mode IIIs (3/8 inch diameter bolt, 4x6 wood member, 1/4 inch steel side plate).

C1.4.1 Moment, Tension, Compression, and Shear. Arch member design strength must equal or exceed the force based on the overstrength load combinations of ASCE/SEI 7-05 but need not exceed nominal forces developed by connections in accordance with Section 1.4.2a. Design for bending, tension, compression and shear, per Section 1.4.1, is based on applicable net section or net bearing areas in accordance with the NDS. Member design at connections, including provisions for shear at connections at member ends and local stresses in fastener groups, is in accordance Section 1.4.2.

C1.4.2 Member Resistance at Connections. This section requires member design at connections for forces that can be developed in the connections or the ASCE/SEI 7-05 overstrength load combinations to increase capacity based on wood strength limit states relative to connection capacity and to provide for limited inelastic behavior at base and peak connections by either wood bearing or fastener yielding or a combination thereof.

In Section 1.4.2, required design wood strength at connections is taken as the lesser of: (a) the nominal strength of the connection for LRFD or the nominal strength divided by 1.35 for ASD or (b) the force based on the ASCE/SEI 7-05 overstrength load combinations. Case b generally will apply when loads other than seismic control the size and number of fasteners in the arch base. When the connection has design strength in excess of that needed to resist seismic forces (e.g., forces from wind exceed calculated seismic forces), it is necessary only to ensure that the wood member has sufficient design strength to resist loads from special load combinations, not the expected strength of the fasteners.

For ASD, wood strength limit states are checked using the nominal strength of the connection divided by a factor of 1.35. The 1.35 factor is specified to provide for consistent design whether provisions of ASD or LRFD are used. For member design (except compression perpendicular to grain) and connection design, the ratio of the LRFD adjusted design value (10 minute basis) to the ASD adjusted design value (10 minute basis) is $2.16/1.6 = 1.35$. The factor of 2.16 is the constant in the format conversion factor, K_F , and adjusts the ASD reference design values (10 year basis) to LRFD design values (10 minute basis) and 1.6 is the load duration factor, C_D , which adjusts the ASD reference design values (10 year basis) to the ASD design values at a 10 minute basis.

C1.5 Transfer of Forces to the Arch Members. Adequate transfer of in-plane diaphragm forces and out-of plane wall and roof forces can be addressed by use of the NDS for wood member and connection resistance and the provisions of ASCE/SEI 7. For anchorage of concrete or masonry structural walls, see ASCE/SEI 7 Sections 12.11 and 12.14.7.5; for bearing walls and shear walls, see ASCE/SEI 7 Section 12.14.7.6; and for nonstructural components, see ASCE/SEI 7 Section 12.14.7.7.

C1.6 End Fixity. Three-hinge arch systems are designed assuming pin behavior when typical construction details of AITC 104 are used; however, it is recognized that limited moment fixity is introduced at the arch base and arch peak connection regions by the presence of connectors and the bearing of the member cross section. For example, at the arch base, rotation about the inside face of the arch at the base coupled with the presence of connections in the arch shoe will provide moment fixity beyond the assumed condition of an ideally pinned joint. The intent of Section 1.6 is to consider the effect of such end fixity as the arch resists anticipated loading.

It is difficult to generate precise estimates of anticipated deformations that may be detrimental to overall connection and member performance. Their effect at the base connection is mitigated through: (a) the use of dowel fasteners in yielding mode, (b) increased strength of dowel fasteners loaded parallel to grain when compared to the same fastener loaded perpendicular to grain, (c) the presence of localized bearing deformations about the arch base and surrounding the dowel, and (d) dowel placement. At the arch peak, tapering of the arch member minimizes fixity created by wood bearing as the arch deforms (see Figure C1.1.2).

Limited cyclic data for single shear, single bolt connections consisting of a steel side plate and a wood main member indicate an average displacement of 0.8 inch at maximum load (see Anderson). For the particular connection tested, the ratio of average maximum strength to LRFD factored resistance was approximately 2.6. Displacement at maximum load and ratio of maximum load to the LRFD factored resistance will vary by connection configuration.

C1.7 Arch Moment Splice. Large arches may employ arch moment splices in locations of reduced moment to facilitate shipping. Like the connection at the peak, these connections are typically prefabricated in a manufacturing facility to establish proper fit and alignment. Compression stress in the moment splice region is resisted by end grain bearing on a metal bearing plate between the connected members. Tension is taken across the splice by steel straps and shear plates, shear is taken by shear plates in end grain, and side plates are used to hold sides and tops of members in position.

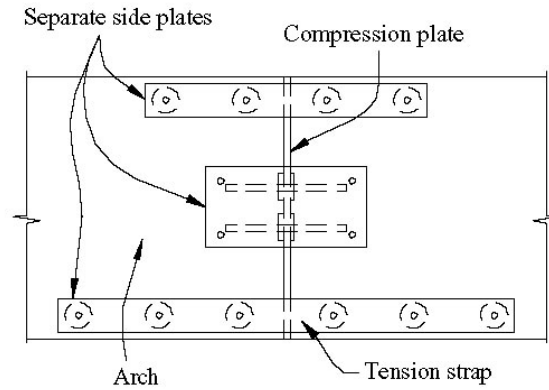

Figure C1.1.3 Typical arch moment splice.

REFERENCES

- Anderson, G. T. Experimental Investigation of Group Action Factor for Bolted Wood Connections, Thesis for Master of Science at Virginia Tech, Blacksburg, Virginia.
- American Institute of Timber Construction. 2003. *Typical Construction Details*, AITC 104-03. AITC, Denver, Colorado.
- American Forest and Paper Association. 2005. *National Design Specification® for Wood Construction (NDS)*, ANSI/AF&PA NDS. AF&PA, Washington D.C.
- American Society of Civil Engineers. 2005. *Minimum Design Loads for Buildings and Other Structures*, ASCE/SEI 7-05. ASCE, Reston, Virginia.

Page intentionally left blank

Resource Paper 8

APPROPRIATE SEISMIC LOAD COMBINATIONS FOR BASE PLATES, ANCHORAGES, AND FOUNDATIONS

The suitability of existing load combinations has been increasingly questioned as building code provisions have shifted from an allowable stress design (ASD) basis towards a strength or load and resistance factor design (LRFD) basis. Foundation design requirements remain grounded in ASD because consensus is lacking on how to convert these requirements to an ultimate strength basis. Disagreement also exists concerning which requirements for base plates and anchorage are appropriate in that building designers are inclined to specify use of the special seismic load combination for these elements whereas designers of nonbuilding structures tend to rely on inelastic behavior and, to some extent, uplift or sliding. This resource paper presents the findings of a study conducted to determine appropriate load conditions for base plates, anchorages (via anchor bolts, anchor rods, or other), and foundations (either shallow or deep).

CONTROLLING BEHAVIOR OF STRUCTURAL COMPONENTS IN SERIES

The system created when a structural element is attached to a base plate, anchorage, and foundation is a “series” combination of structure elements as shown in Figure 1. In the simplest sense, a series combination can be conceptualized as a chain of components in which the maximum strength and deformation capacity of the combination is controlled by whichever component is the weakest in the series.

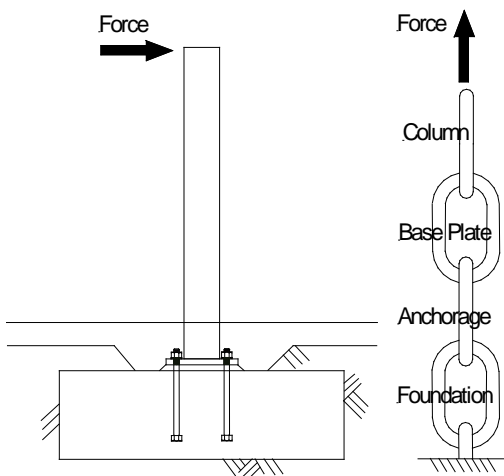

Figure 1 Structural elements in series (column, base plate, anchorage, foundation, and soil).

In actuality, each component has different strength and deformation capacities. Figure 2 illustrates the strength and deformation capacities of three imaginary components. System 1 is a flexible ductile element; System 2 is a rigid and weaker but ductile element; and System 3 is a rigid and brittle but strong element.

If these elements are connected into a series, the combined strength and deformation capacity of the system would be determined by summation of the individual displacements of each element at any given force level (Figure 3). This type of combination is referred to as a force-dependent structural system.

For the example shown in Figure 2, the combined strength and ductility capacity of the structural system is entirely controlled by System 2, because both the yield and ultimate strength of System 2 is less than the yield strength of either System 1 or System 3. For purposes of discussion, the behavior of System 1 might be imagined as that of a building structural element, System 2 might be the rocking behavior of a shallow foundation, and System 3 might be that of a low-ductility base plate and anchorage. The low ductility of System 3 is not a problem because this element always remains elastic; however, the low strength of System 2 may be a problem because it prevents the relatively good ductility of System 1 from being utilized.

In order to transition the controlling behavior and mechanism from System 2 to that of System 1, the required strength of System 2 needs to be increased until the ultimate strength of System 1 is less than that of System 2 as shown in Figure 3. This demonstrates that appropriate scaling of the seismic component in load combinations is a necessary factor in controlling structural behavior.

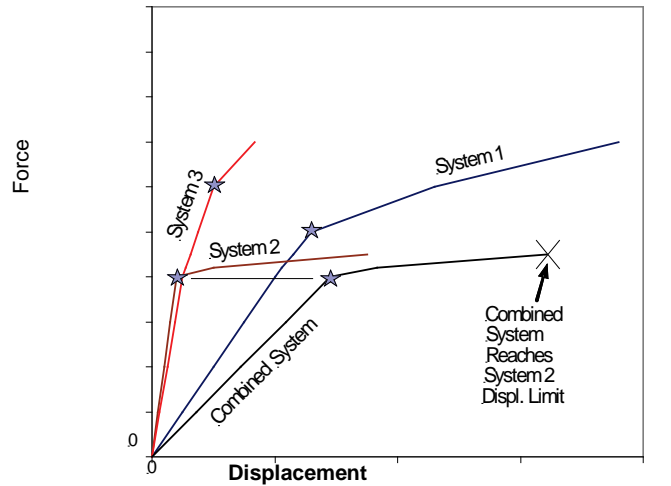

Figure 2 Force versus displacement of series-connected elements.

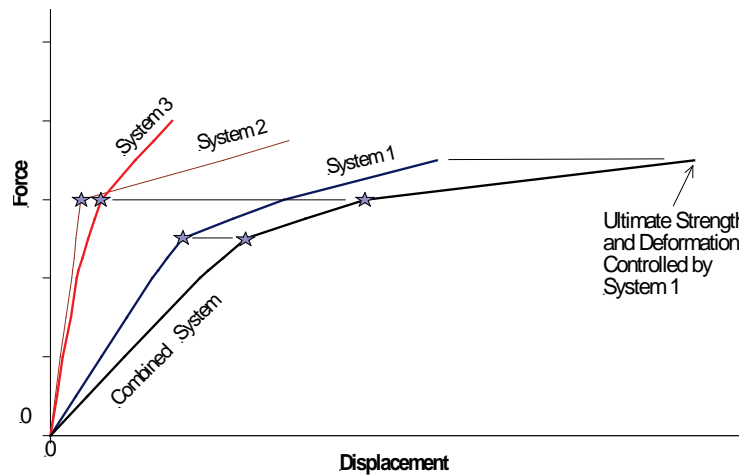

Figure 3 Using load factors to increase required strength of System 2 causes behavior to be controlled by System 1.

Base Plates and Anchorages. Base plates and anchorages are commonly used for: steel structures; light-frame structures; large nonbuilding structures such as tanks, vessels, and signs; equipment attachments; and nonstructural component attachments. Design standards and ductility requirements vary considerably for these items. Table 1 summarizes some of the broad variety of criteria currently used to define the seismic strength requirements and permitted capacity values for various types of structural elements that typically use some form of anchor rods/bolts and base plates or anchorages.

Current design standards for steel buildings specify use of the special load combination for base plates and anchor rods¹ for steel columns unless the provisions of ASCE/SEI 7-05 Table 12.2-1 System (H) are permitted. When anchor rods may be needed to attach elements other than columns, increased strength requirements are not currently required.

When anchor bolts are required for light-frame construction, current design standards generally do not require any different strength requirements than for the attached structural component.

Designers of some types of nonbuilding structure have shown a preference for using foundation anchor bolts as a yield mechanism to provide structural ductility. For example, ASCE/SEI 7-05 Section 15.7.5 and API standards require that the vertical vessel structures typically found in oil refineries, which do not have significant ductility, be intentionally designed to create a plastic mechanism of tensile yielding in the anchor bolts used to attach the vessel to its foundation. The anchor bolts

¹ AISC has introduced the term “anchor rod” to describe a bolt that attaches steel to concrete, but other standards groups continue to use the term “anchor bolt.” This paper uses the term “anchor rod” when specifically referring to AISC standards and the term “anchor bolt” with respect to anchorage in general.

are specified to use ductile material and to be installed in a manner that facilitates tensile yielding over a significant length of the bolt. The anchorage used to attach the anchor bolts to the vessel as well as the vessel itself is then designed to mobilize the full strength of the anchor bolts.

Table 1 Summary of Selected Criteria

	System Type	R_{max}	Element	Required Seismic Load Effect	Design Criteria	Average Anchor or Attachment Strength Relative to Supported Item
Steel Buildings	High seismic; SDC D-F (AISC definition)	SPSW ^f $R = 7$	Attachments	E	AISC Seismic	Same
			Anchorage	Uncertain	ACI D3.3 w/AISC modifications	Same
		Other system types, $R_{max} = 8$	Base plate	E_m	AISC Seismic	Same
			Anchorage	E_m	ACI D3.3 w/AISC modifications	Same
	Low seismic; SDC A-C (AISC definition)	Systems with > 3	(Same as high-seismic SDC D-F requirements)			
		Systems with $R \leq 3.0$	Base plate	E	AISC 360	Same or weaker ^b
			Anchorage	E	ACI D3.3	Same or weaker ^b
Light-Frame Buildings	Shear wall	7.0	Uplift devices	$E/1.4$	ICC-ES	Varies
			Uplift anchorage	E	ACI D3.3, SDC C-F	Stronger ^a
				E	ACI D3.3, SDC A-B	Same
			Shear anchorage	E	ACI D3.3, SDC C-F	Stronger ^a
				E	ACI D3.3, SDC A-B	Same
Nonbuilding Structures	Having building-like structural systems	8.0	Same as steel buildings including high and low seismic categorization			
	Other types	3.5	Base plate and attachments	E	AISC 360 ^e	Same
			Anchorage	E	ACI D3.3, SDC C-F other industry standards may govern	Stronger ^a
				E	ACI D3.3, SDC A-B	Same
Nonstructural Components	Supports and attachments for ductwork or welded piping	$R_p = 10.0^d$ max	Base plate and attachments	E or $E/1.4$	Generally from ICC-ES ESRs	Same
	Supports and attachments for other components	$R_p = 6.0$ max	Base plate and attachments	E or $E/1.4$	Generally from ICC-ES ESRs	Same
	Anchors seismically-qualified or per ACI D3.3)	$R_p = 6.0$ max	Anchorage per ASCE 13.4	E	ICC-ES AC193, AC308	?
					ACI D3.3, SDC C-F	Stronger ^a
					ACI D3.3, SDC A-B	Same
Other nonductile anchors	$R_p = 1.5$	Anchorage per ASCE 13.4	$(1.5/R_p) E$	ICC-ES AC193, AC308	Stronger	

^a Presumed stronger because ACI D3.3 applies a 0.75 strength reduction factor to the anchor strength.

^b Weaker when supported item strength is determined by drift or other considerations.

^c ASD strengths determined using ICC-ES reports are based on tests.

^d Welded piping with $R_p=12$ is effectively only $R_p=10$ because of the $F_{p,min}$ requirement.

^e API and AWWA requires anchorage to be designed for yield load of anchor.

^f SPSW = steel plate shear walls.

Nonstructural components such as fan motors, piping systems, and building facades often have cast-in or post-installed anchors with limited or no ductility for support. In some instances, the anchorage or bracket used to attach the component to the anchor is the element most capable of providing some degree of ductility in the attachment. In many cases, imposed displacements are the controlling factor in the anchorage design.

There is too much variety in structure and attachment types to define any single target behavior about which load combinations might be developed. Considering the wide variety of structures and components that utilize base plates and anchorages, there exist valid justifications to define ductility requirements for the structural element, the base plate/anchorage, or the anchor bolt. Recommended future code development should instead target rational rules within the three basic arenas of yield mechanisms. For each situation, specific design and detailing rules are appropriate to include in conjunction with the intended yield mechanism.

For the anchor rod/bolt as a yield mechanism:

1. Design the base plate/anchorage to resist the actual (not specified) tensile strength of the anchor bolt.
2. Design the foundation anchorage to resist the actual tensile strength of the anchor bolt.
3. Use ductile steel for the anchor bolt and nuts capable of developing the anchor bolt strength.
4. In the case of cast-in and post-installed grouted anchors, consider de-bonding the anchor bolt from the concrete over a significant length (inelastic length) to permit development of meaningful displacements.
5. Either use continuously threaded rod to ensure uniform yielding over the inelastic length of the anchor bolt or ensure that the rod material has sufficient tensile strength relative to its yield strength that the rod is fully yielded before tension fracture occurs. Upset threads are not considered necessary for anchors resisting seismic loads.
6. Consider use of nuts on both sides of the base plate so that progressive elongation of the anchor bolt is reduced and cyclic reversals have a chance to cycle rod in compression (however, anchor bolts are not recommended for direct transfer of shear forces).
7. Provide adequate stretch length in the yielding section of anchor bolts to accommodate maximum expected inelastic displacements and rotations.

For the anchorage/base plate as a yield mechanism:

1. Design the anchor bolt, particularly if nonductile (e.g., an expansion bolt), to be stronger (elastic strength) than the yield strength of the anchorage assembly and with adequate displacement capacity to accommodate maximum joint movements.
2. Qualify post-installed anchor bolts by appropriate testing to confirm adequate strength and ductility characteristics under anticipated design conditions.
3. Although using an anchorage or base plate as the intended yield mechanism may be successful at protecting a nonductile anchor bolt from failure, the total work performed in a small anchorage may not provide adequate hysteresis to reduce global structural seismic behavior.

For an unyielding anchorage/anchor bolt assembly:

1. Utilize the design requirements for the non-ductile structural elements that currently exist.
2. Ensure that the load-amplification provisions for the anchor bolt/rod and base plate which are expected to remain elastic do not overlap.

FOUNDATIONS

A geotechnical engineer tends to define the ultimate strength of a foundation at a point when either an unstable soil movement is imminent or a limiting value of displacement is reached. A structural engineer tends to define the ultimate strength of a foundation at a point when either the occurrence of an unstable mechanism within the structure is imminent (such as rocking) or a structural capacity is reached. In other words, the geotechnical engineer assumes that the soil will fail before the structure, and the structural engineer assumes that soil behavior can be simplified to the extent of being a simple fluid or force; neither assumption is correct.

In conventional design, the geotechnical engineers need to define soil strength values for both seismic and long-term load conditions early in the design process when the size, shape, and ultimate loading on the foundations are, at best, only rough estimates. Unless ultimate foundation strengths can be re-evaluated by the geotechnical engineer at a later design stage when the sizes, shapes, and loading of foundations are relatively definite, the geotechnical engineer typically will maintain some degree of conservatism with respect to potential geotechnical mechanisms.

The traditional practice of arbitrarily defining a one-third increase in permitted long-term soil pressures for seismic loading does not adequately reflect what is necessary to transition from ASD to an ultimate strength design. While the one-third increase might be suitable for checking stresses for a 100-year wind event, it is not suitable for determining adequacy for a limit-state seismic event. It is therefore necessary to separately define design limit values for limit-state and long-term load conditions.

Table 1804.2 of the 2006 *International Building Code* (IBC) reproduced below requires substantial revision as part of any change to strength design procedures.

2006 IBC Table 1804.2 Allowable Foundation and Bearing Pressure

CLASS OF MATERIALS	Allowable Foundation Pressure (psf) ^d	Lateral Bearing (psf/ft below natural grade) ^d	Lateral Sliding	
			Coefficient of friction ^a	Resistance (psf) ^b
1. Crystalline bedrock	12,000	1,200	0.70	--
2. Sedimentary and foliated rock	4,000	400	0.35	--
3. Sandy gravel and/or gravel (GW and GP)	3,000	200	0.35	--
4. Sand, silty sand, clayey sand, silty gravel and clayey gravel (SW, SP, SM, SC, GM, and GC)	2,000	150	0.25	--
5. Clay, sandy clay, silty clay, clayey silt, silt and sandy silt (CL, ML, MH and CH)	1,500 ^c	100	--	130

^aCoefficient to be multiplied by the dead load.

^bLateral sliding resistance value to be multiplied by the contact area as limited by Section 1804.3.

^cWhere the building official determines that in-place soils with an allowable bearing capacity of less than 1,500 psf are likely to be present at the site, the allowable bearing capacity shall be determined by a soils investigation.

^dAn increase of one-third is permitted when using the alternate load combinations in Section 1605.3.2 that include wind or earthquake loads.

Performance Statement for Soil Limit-State Condition. In order to define the soil and foundation strength values associated with limit-state design, a definitive performance statement for structural and geotechnical conditions at the limit state needs to be developed.

When structural actions result in repeated cycles of loading at or near the limit-state soil pressure, some degree of progressive foundation settlement is expected to occur due to compaction and local shear movements of soil materials beneath the foundation as shown in Figure 4. The total and differential settlements resulting from repeated cycles of loading should be considered in the light of the performance-based design criteria. Large total settlement may not be detrimental if the differential settlements between adjacent foundations are within acceptable limits.

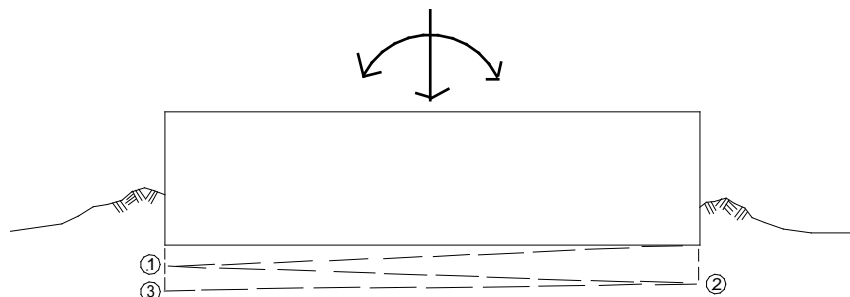

Figure 4 Progressive settlement during repeated cycling.

Rotational mechanisms of foundations due to soil shear failures as shown in Figure 5 should not be permitted. Maximum structure overturning moments should maintain a factor of safety against soil shear failure mechanisms of at least 2; otherwise foundations should be interconnected by grade beams so that the resulting soil loading will be primarily direct compression.

Lateral sliding of buildings and other structures may be resisted by both friction and passive soil pressure. Lateral displacement or sliding of foundations during the design event may be permissible; however, structural stability must be maintained.

Strength and Overstrength of Shallow Foundations. Past and current code provisions for both shallow and deep foundations have been based on allowable strength design methodology. FEMA 450-1 includes an appendix that has proposed a new strength design methodology. An evaluation of foundation design provisions must address both methodologies.

Selected 2006 IBC sections relative to seismic load combination requirements for shallow foundations are:

1. Section 1605.2.1 – permits use of strength load combinations in conjunction with the maximum 25 percent reduction in overturning moment permitted in ASCE/SEI 7 Section 12.13.4.
2. Section 1605.3.1 – permits use of ASD load combinations $[D + H + F + 0.7E]$ and $[0.6D + 0.7E + H]$.
3. Section 1605.3.2 – permits use of alternative ASD load combinations $[D + L + S + E/1.4]$ and $[0.9D + E/1.4]$ without the overturning reduction permitted by ASCE/SEI 7-05 Section 12.13.4.
4. Table 1804.2, Footnote d, permits a one-third increase in allowable soil pressures when using the alternate load combinations that include seismic loads.

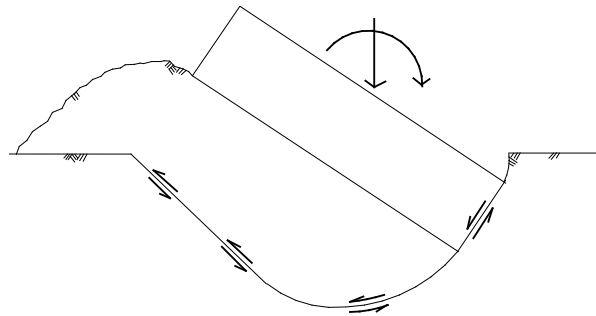

Figure 5 Foundation rotational mechanism within soil.

Proposed new IBC Table (expected to follow existing Table 1804.2) Limit-state Foundation and Bearing Pressure (for use with Section xxx, Load Conditions)

Class of Materials	Ultimate Foundation Pressure (psf)	Lateral Bearing (psf/ft below natural grade)	Lateral Sliding	
			Coefficient of friction	Resistance (psf)
1. Crystalline bedrock	24,000	2,500	0.70	--
2. Sedimentary and foliated rock	10,000	1,000	0.35	--
3. Sandy gravel and/or gravel (GW and GP)	8,000	600	0.35	--
4. Sand, silty sand, clayey sand, silty gravel and clayey gravel (SW, SP, SM, SC, GM, and GC)	6,000	500	0.25	--
5. Clay, sandy clay, silty clay, clayey silt, silt and sandy silt (CL, ML, MH and CH)	4,500	300	--	400

The load combinations defined in Section 1605.3.2, in combination with the one-third increase permitted in Table 1804.2 are commonly used in current practice.

An unusual additional load combination provision is found in ACI 318 Section 15.2.2: “Base area of footing or number and arrangement of piles shall be determined from unfactored forces and moments transmitted by footing to soil or piles and permissible soil pressure of permissible pile capacity determined through principles of soil mechanics.” Although ACI 318, Section 21.10 (seismic foundation requirements), does not override this section, it does conflict with IBC Section 1605, which would govern over the ACI provision.

Traditionally, the structural design of shallow foundations assumes that soil pressure beneath the foundations can be treated as a linearly-varying pressure across the length of the foundation, forming a pressure diagram which, depending upon the degree of eccentricity, $e = M/P$, can be described as either trapezoidal or triangular in shape. The 2003 *NEHRP Recommended Provisions* (FEMA 450) introduced a foundation strength design approach that permits a Whitney stress-block approach to be used to simulate an ultimate soil pressure condition to be used to design shallow foundations. Appendix 1 of this paper presents a summary of Equations 1 and 2, which describe the ASD load limits of simple rectangular-in-plan foundations. It also includes an Equation 3 that describes the strength limits for the strength design approach introduced in 2003 Provisions and now described in Resource Paper 4 of this volume. Using Equations 1 through 3, simple load vs. moment interaction curves can be developed for any rectangular foundation shape.

Figure 6 presents an example interaction curve for a 10-foot square foundation with an allowable long-term soil pressure of 3 ksf and an assumed ultimate soil strength of 9 ksf. In the figure:

1. The radial line occurs at $e = L/6$, the transition from trapezoidal to triangular soil pressure distribution.
2. Line 1 represents an interaction curve using ASD design assumptions with an allowable soil pressure of 3 ksf.

3. Line 2 represents the effect of a 33 percent allowable increase in soil pressure for temporary load conditions to 4 ksf.
4. Line 3 represents the effect of using IBC Section 1605.3.2 to design foundations (the reduction of $E/1.4$ is represented as an increase in allowable soil pressure by a factor of 1.4).
5. Line 4 represents the interaction curve at the ultimate soil pressure of 9 ksf using traditional triangular/trapezoidal soil pressure distribution (i.e., the ultimate soil pressure occurs only at the extreme edge of the foundation).
6. Line 5 represents the interaction curve at the ultimate soil pressure of 9 ksf using an equal-pressure soil distribution.

The overstrength of the traditional ASD design approach can be expressed as the ratio between the presumed ultimate (Line 5) and the design-level (Line 3) interaction curves. The amount of overstrength that results using the ASD design approach is not constant; it varies significantly depending on how much vertical load is on the foundation. Let us define P as the actual vertical load on a foundation and P' as the theoretical maximum permitted vertical load capacity of a concentrically loaded foundation (equal to the maximum permitted soil pressure times the total footing area). For more lightly loaded foundations (having $P/P' < 0.5$), the amount of overstrength present varies significantly to the extent that when a foundation is at $P/P' = 0$ (such as when a foundation is loaded in direct uplift), the effective factor of safety present is 1.0 (i.e., no overstrength).

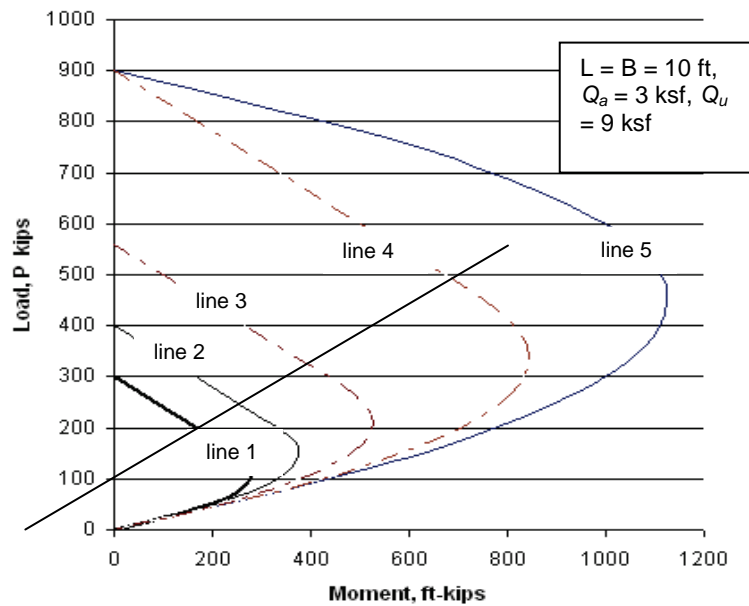

Figure 6 Example interaction curve for a shallow foundation.

Although the foundation strength design approach defined in the FEMA 450 Appendix to Chapter 7, introduced in 2003 Provisions and now described in Resource Paper 4 of this volume, defines procedures that can be used to determine an ultimate strength design such as shown in Line 5 of Figure 6, it is silent regarding which strength load combinations to use for design. The available alternatives are either the ASCE/SEI 7 seismic load combinations defined in Section 12.4.2.3 or the special load combinations defined in Section 12.4.3.2.

The basic strength load combinations are not generally appropriate for use in conjunction with ultimate foundation strength values. Using load combinations incorporating $1.0E$ together with the ultimate foundation strength means that the design procedure permits no overstrength to be present at all in the design (i.e., that foundation failure will always be the dominant controlling mechanism in any structure). It also means that the expected ductility capacity of the resulting foundation mechanism must equal or exceed the value of R used in the design (whereas for the building structure the expected ductility demand is $R_d = R/R_o$). If the special load combination is used in conjunction with ultimate foundation strength values, foundation rocking or sliding mechanisms are unlikely to be a controlling or participating mechanism in the structure response. While this might be an acceptable or desired characteristic for structures using high- R systems or for essential facilities, it is probably an undesirable characteristic for ordinary-use structures using moderate- or low- R systems. Because modest levels of foundation nonlinearity generally are considered to be acceptable for ordinary structures using moderate- or low- R systems, the use of the special load combinations would prevent such action and would result in an increase in their expected construction cost.

Strength of Deep Foundations. Although the ultimate strength of a deep foundation cannot be simplified in the same manner as a shallow foundation, simplified methods can be used to predict ultimate strength values with a slight resemblance to reality. Geotechnical engineers can determine allowable ultimate and long-term load capacities of assumed pile groups, translate that into individual-pile ultimate and long-term load values for the structural engineer, and the structural engineer then can translate those back into predicted ultimate and long-term pier or pile-group capacities that may or may not resemble the values originally determined by the geotechnical engineer.

Appendix 2 of this paper presents two examples of how a structural engineer might estimate the ultimate strength of a pile group based on individual-pile capacities. Both of these approaches are vast oversimplifications of the actual interaction and response that occurs between the structure and soil of a deep foundation, but they are both simple enough for practicing engineers to adopt as design practice. The first example is a modification of a current common design practice for multi-pile foundations that assumes the ultimate strength point is reached when the outermost pile reaches a defined ultimate strength. The second example is a plastic-analysis approach that assumes all piles in a pile group are eventually able to reach their defined ultimate strengths. The plastic analysis approach likely overestimates the strength that a multi-pile group is capable of developing; however, the 0.7ϕ factor will provide significant compensation when using either approach. Further, both approaches require that the pile cap structure have sufficient strength to accommodate the full expected strength of the foundation capacity that is used, but many engineers probably would prefer the more conventional linear-strain approach in order to reduce the required strength of pile caps.

More accurate methods to predict the ultimate strength of deep foundations include field testing of individual piles, reduced-scale testing of pile groups, and prediction of strength and deformation states of both foundation and soil through complex models of the combined foundation and surrounding soil. Analysis of soil seismic behavior in this manner should include the strain-dependent strength of the soil materials due to both foundation loading and ongoing seismic deformations.

Overstrength of Deep Foundations. Deep foundations are significantly different from shallow foundations in that deep foundations can have tensile strength, overturning strength with low gravity loads, and element overstrength properties similar to superstructure elements. Deep foundations therefore might be capable of internally developing overstrength values in the range of tabulated Ω_0 values provided that adequate ductility is present in the piles. Thus, for deep foundation, there is no clear need for specifying a special or increased load combination in order to offset a lack of overstrength in the foundation system as there is for lightly loaded shallow foundation systems. However, earthquake damage in deep foundations is difficult to detect and is probably frequently overlooked in post-earthquake damage investigations and, even if detected, it is very costly to repair. This might justify an increase in deep foundation strength for higher Seismic Design Category structures since foundations for these structures might be expected to experience more than one damaging earthquake during the foundation's service life and the potential loss-of-use and repair costs are less acceptable.

Recommendations for Foundations. Foundation design including soil pressures for either shallow or deep foundation systems might utilize ultimate strength design load combinations in which the value of E is as shown in Tables 2 and 3.

Table 2 Buildings and Building-like Nonbuilding Structures

<i>R</i> Value from ASCE/SEI 7 Table 12.2-1, 12.14-1, or 15.4-1	Fixed-Base Analysis	Including Foundation Deformations per ASCE/SEI41
For $R \geq 5$	$2.0 E$	$1.5 E$
R 3 to < 5	$1.5 E$	$1.0 E$
$R \leq 3$	$1.0 E$	$1.0 E$

Table 3 Nonbuilding Structures Not Similar to Buildings

<i>R</i> Value from ASCE/SEI 7 Table 15.4-2	Fixed-Base Analysis	Including Foundation Deformations per ASCE/SEI 41
$R > 3$	$1.5 E$	$1.0 E$
$R \leq 3$	$1.0 E$	$1.0 E$

It is likely that this scaling would apply to the full value of $E = E_h + E_v$ used in design with no other reduction permitted; however, it is recognized that the full effects of design including redundancy factors, importance factors, and the vertical seismic component have not been studied in depth and that the results of such an in-depth study might warrant further changes. These load factor scaling factors were selected in conjunction with the foundation-soil strength values (including phi-factors) presented in this paper. Inherently, the load factor of $2.0E$ is intended to result in a structure in which inelastic response is preferred in the portions of the structure that are above the foundation and base plate while the load factor of $1.0E$ was selected with the intent that some inelastic response might be preferred in the foundation of light structures. The load

factor of $1.5E$ was selected as a value that would provide for inelastic response in the foundation, in the supported structure, or in both elements.

It is recognized that simple rules often yield imperfect results and that some structural systems might be identified that defy the logic of this reasoning. For instance, foundations beneath shear panels of light-frame buildings would be required to be designed using $2.0E$ suggesting that the foundations beneath these elements should remain relatively elastic while many engineers might argue that a load factor of $1.5E$ might be more appropriate. However, until a more rational means of determining R values prevails, this relatively simple table was judged to be generally effective in providing the preferred inelastic behavior distribution.

No distinction was made between the load factor recommendations for deep and shallow foundations because the load factors recommended appear likely to result in at least as much successful behavior for deep as opposed to shallow foundations.

Common ASD methods currently used for seismic design can be approximately matched with the ultimate foundation strengths discussed herein by dividing calculated ultimate foundation strengths by a factor of safety of 3.0 and using the earthquake forces recommended above reduced by a factor of 1.4.

REFERENCES

DeVall, Ronald H. April 2003. "Background information for some of the proposed earthquake design provisions for the 2005 edition of the National Building Code of Canada." NRC Research Press.

Canadian Commission on Building and Fire Codes. 2005. *National Building Code of Canada*, Vol. 1 and Commentary. National Research Council of Canada.

International Code Council. 2006. *International Building Code*.

American Concrete Institute. 2005. *Building Code Requirements for Structural Concrete and Commentary*, ACI 318-05.

American Institute of Steel Construction. 2005. *Seismic Provisions for Structural Steel Buildings*, AISC 341-05.

Appendix 1, DERIVATION OF SHALLOW FOUNDATION EQUATIONS

Traditional ASD Design – Full Contact

Given: P = vertical load
 M = overturning moment
 L = length of rectangular footing
 B = width of rectangular footing
 $e = M/P$ = eccentricity of loading
 Q_A = maximum ASD allowable soil pressure

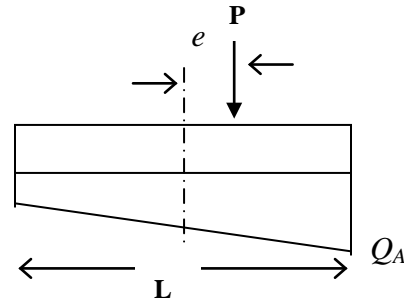

From the standard ending stress equation:

$\sigma = P/A \pm M/S$, the maximum soil pressure, Q_A will be:

$$Q_A = \frac{P}{BL} + \frac{6M}{BL^2} = \frac{P}{BL} \left(1 + \frac{6e}{L} \right)$$

Rearranging,

$$e = \frac{L}{6} \left(\frac{Q_A}{P} BL - 1 \right)$$

Introduce the term: $P' = Q_A BL$ so that we can substitute $BL = P'/Q_A$ resulting in

$$\frac{e}{L} = \frac{1}{6} \left(\frac{P}{P'} - 1 \right) \quad (1)$$

Traditional ASD Design – Partial Contact

For $e \geq L/6$, the soil pressure is assumed as a triangular distribution.

$$Q_A = \frac{2P}{3B \left(\frac{L}{2} - e \right)}$$

Rearranging,

$$e = \frac{L}{2} - \frac{2}{3} \frac{P}{Q_A B}$$

Substituting $Q_A B = P'/L$,

$$\frac{e}{L} = \frac{1}{2} \left[1 - \frac{4}{3} \left(\frac{P}{P'} \right) \right] \quad (2)$$

At the transition point between Equations 1 and 2, $e = L/6$ and $P/P' = 1/2$. The following is a graph of Equations 1 and 2:

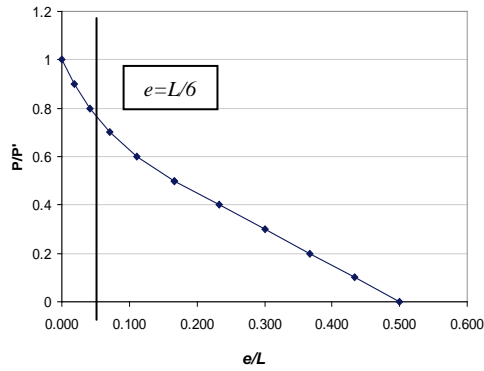

Simplified Ultimate Strength Design Method

A simplified ultimate strength design approach, based on the Whitney Stress Block Method, follows:

Define (in addition to terms used above):

$$Q_U = \text{Ultimate Soil Pressure}$$

For an assumed rectangular soil pressure distribution;

$$Q_U = \frac{P}{2B\left(\frac{L}{2} - e\right)}$$

Substituting $B = \frac{P'}{LQ_A}$:

$$\frac{e}{L} = \frac{1}{2} \left[1 - \left(\frac{Q_A}{Q_U} \right) \left(\frac{P}{P'} \right) \right] \tag{3}$$

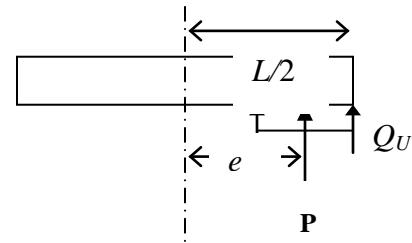

Graphing this equation against the ASD equations:

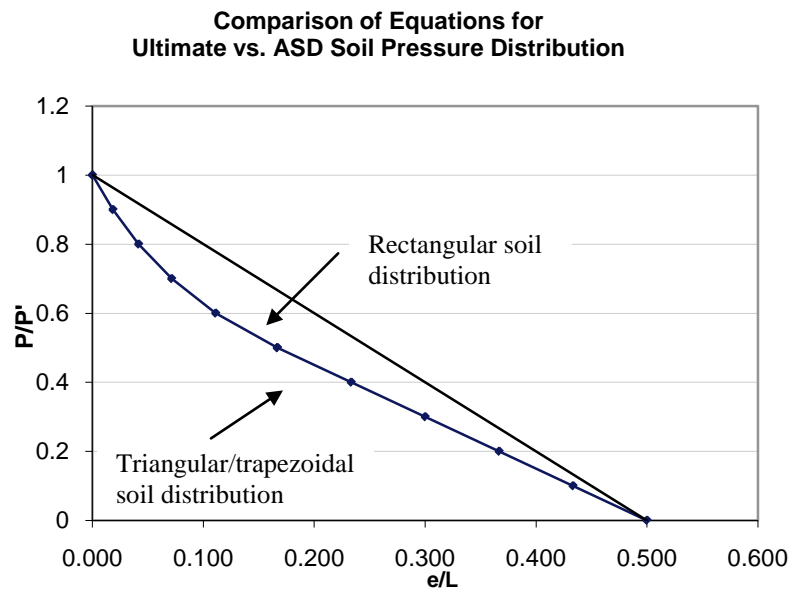

Appendix 2, ASD AND LRFD INTERACTION DIAGRAMS FOR DEEP FOUNDATIONS

Linear Strain Assumption

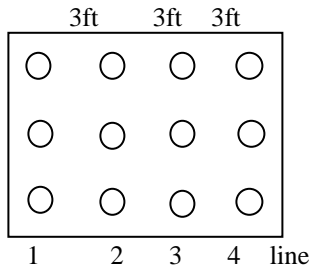

Assumed ASD Allowable Pile Capacities

$$P = 100 \text{ kips}$$

$$T = -50 \text{ kips}$$

$$\text{Ultimate/ASD} = 1.7 \text{ tension}$$

$$\text{Ultimate/ASD} = 2.5 \text{ compression}$$

(does not include $\phi = 0.7$)

Point 1 - Pure compression

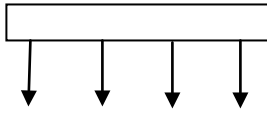

Line	# piles	#piles x Pile force	x	Px
1	3	300	-4.5	-1350.0
2	3	300	-1.5	-450.0
3	3	300	1.5	450.0
4	3	300	4.5	1350.0
Sum =		1200		0.0

ASD Capacity

1200 kips

0.0 ft kips

USD Capacity

3000 kips

0.0 ft kips

Point 2 - Max. Moment

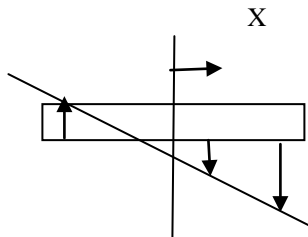

ASD:

$$X_{na} = -1.50 \text{ ft}$$

USD:

$$X_{na} = -2.22 \text{ ft}$$

ASD:

Line	# piles	#piles x Pile force	x	Px
1	3	-150	-4.5	675.0
2	3	0	-1.5	0.0
3	3	150	1.5	225.0
4	3	300	4.5	1350.0
Sum =		300		2250.0

ASD Capacity

300 kips

2250.0 ft kips

USD:

Line	# piles	#piles x Pile force	x	Px
1	3	-255	-4.5	1147.5
2	3	80	-1.5	-120.0
3	3	415	1.5	622.5
4	3	750	4.5	3375.0
Sum =		990		5025.0

USD Capacity

990 kips

5025.0 ft kips

Point 3 - Pure tension



$$P = 4 * 3 * -50 = -600 \text{ kips}$$

$$M = 0.0 \text{ ft kips}$$

ASD Capacity	USD Capacity
-600 kips	-1020 kips
0.0 ft kips	0.0 ft kips

Fully Plastic Assumption

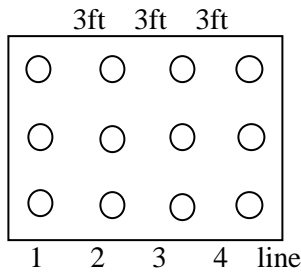

ASD Allowable Pile Capacities

P = 100 kips
T = -50 kips

Ultimate/ASD = 1.7 tension
Ultimate/ASD = 2.5 compression
(does not include $\phi = 0.7$)

Point 1

Line	# piles	#piles x Pile force	X	Px	USD Capacity
1	3	750	-4.5	-3375.0	3000 kips
2	3	750	-1.5	-1125.0	0.0 ft kips
3	3	750	1.5	1125.0	
4	3	750	4.5	3375.0	
Sum =		3000		0.0	

Point 2

Line	# piles	#piles x Pile force	X	Px	USD Capacity
1	3	-255	-4.5	1147.5	
2	3	750	-1.5	-1125.0	
3	3	750	1.5	1125.0	1995 kips
4	3	750	4.5	3375.0	4522.5 ft kips
Sum =		1995		4522.5	

Point 3

Line	# piles	#piles x Pile force	X	Px	USD Capacity
1	3	-255	-4.5	1147.5	
2	3	-255	-1.5	382.5	990 kips
3	3	750	1.5	1125.0	6030.0 ft kips
4	3	750	4.5	3375.0	
Sum =		990		6030.0	

Point 4

Line	# piles	#piles x Pile force	X	Px	USD Capacity
1	3	-255	-4.5	1147.5	
2	3	-255	-1.5	382.5	-15 kips
3	3	-255	1.5	-382.5	4522.5 ft kips
4	3	750	4.5	3375.0	
Sum =		-15		4522.5	

Point 5

Line	# piles	#piles x Pile force	x	Px
1	3	-255	-4.5	1147.5
2	3	-255	-1.5	382.5
3	3	-255	1.5	-382.5
4	3	-255	4.5	-1147.5
Sum =		-1020		0.0

USD Capacity	
-1020	kips
0.0	ft kips

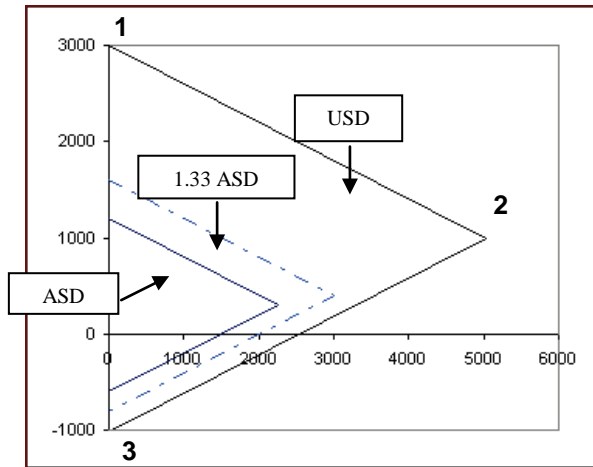

Linear Strain Assumption

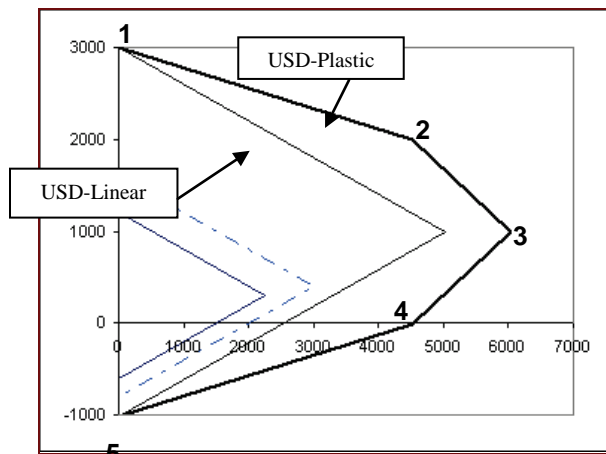

Fully Plastic Assumption,
Superimposed on Linear Strain Assumption

Resource Paper 9

SEISMIC DESIGN USING TARGET DRIFT, DUCTILITY, AND PLASTIC MECHANISMS AS PERFORMANCE CRITERIA

Traditional seismic design methods operate in the elastic domain and use a response modification coefficient in conjunction with a period of vibration to establish required member strengths. This resource paper presents a design approach that establishes the base shear required to limit ductility and drift demands based on an estimate of the yield displacement and uses a plastic mechanism analysis to establish required member strengths. It is suggested as an alternative to the equivalent lateral force procedure and is presented in Part 3 of the 2009 NEHRP Recommended Seismic Provisions in order to expose the approach to the design community and to elicit feedback from members of that community.

BACKGROUND

Traditional seismic design methods operate in the elastic domain and use a response modification coefficient in conjunction with a period of vibration to establish required member strengths. The design approach presented here is an alternative to the equivalent lateral force (ELF) procedure. Several recent developments are combined to achieve simplicity and transparency in the design process. Unique features of this design approach are:

1. An estimate of the yield displacement in a first-mode pushover analysis is used as an initial basis for proportioning the seismic-force-resisting system in a manner analogous to the way that an estimated period is used in current code approaches. This approach reduces the need for iterations in proportioning the structural system.
2. Equivalent-single-degree-of-freedom (ESDOF) systems are used explicitly for determining the required base shear strength; estimates of modal parameters are used in preliminary design.
3. The required base shear strength is determined using a representation of inelastic spectra known as yield point spectra (YPS). The elastic portion of the YPS is given by smoothed elastic design spectra defined in the 2009 *NEHRP Recommended Seismic Provisions*; inelastic portions are derived on the basis of coefficient relationships that were recommended in a 2005 report published by the Federal Emergency Management Agency, *Improvement of Nonlinear Static Seismic Analysis Procedures* (FEMA 440).
4. An improved lateral force distribution is used which results in a more uniform distribution of peak interstory drifts over the height of the structure as well as a reduction in column design moments relative to those obtained with the current ELF procedure.
5. A plastic mechanism analysis is used to determine required member strengths given the required base shear strength. The analysis assists the engineer in visualizing the intended mechanism, makes preliminary sizing of designated yielding members very simple, and helps ensure that an intended mechanism actually develops.

System ductility demands are a measure of damage to structural components. Values of system ductility corresponding to currently recognized seismic-force-resisting systems are suggested for use with this approach. Interstory drift is a measure of damage to nonstructural components. Relationships between interstory drift and roof drift are suggested as a basis for complying with currently recognized allowable story drift limits. System ductility and roof drift limits are explicitly considered when establishing the required base shear strength, in order to limit damage to structural and nonstructural components.

In many cases, the estimate of the yield displacement will be sufficiently accurate that no iteration of the preliminary design will be needed.

Figure 1 illustrates how system ductility and roof drift limits define regions where the yield points of single-degree-of-freedom (SDOF) and equivalent SDOF (or ESDOF) systems either satisfy the ductility and drift limits or fail to satisfy one or both of these limits. For a given yield displacement, satisfaction of both limits requires that the larger of the associated yield strengths be provided. Because a change in strength is usually achieved by changing the amount of structural material, the stiffness changes as well. Thus, the period of vibration is a consequence of the strength provided to satisfy drift and ductility limits, and an estimate of the yield displacement is used as a starting point rather than an estimate of the period. The admissible design region shown in Figure 1 was derived for a particular performance objective; when multiple performance objectives must be considered, each may further constrain the admissible design region. Details of the construction and interpretation of YPS are provided in the appendix to this paper.

Because the lateral force distribution results in more uniform peak interstory drifts over the height of the structure, those structures for which interstory drift is the controlling design parameter can be allowed to achieve larger peak roof drifts relative to those obtained with current code approaches. As a result, structures that are slightly more flexible (longer period) than obtained with current code approaches may be found to be acceptable.

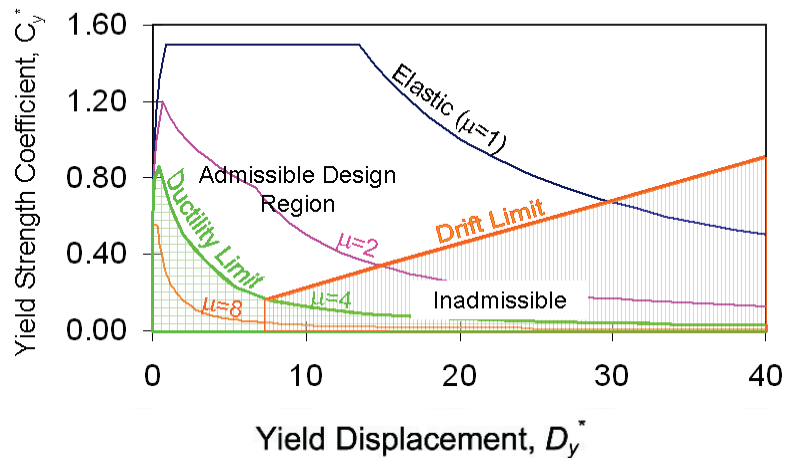

Figure 1 Limits on ductility and drift demands are used to establish admissible and inadmissible design regions. SDOF and ESDOF oscillators that have yield points located within the admissible design region satisfy the ductility and drift limits shown.

Because the design is based on estimates of relatively stable parameters (yield displacement, first-mode participation factor, and first-mode mass coefficient) as well as the use of a plastic mechanism, little or no iteration in member sizes is required in typical cases. In some cases, by ensuring compatibility of the modal parameters obtained for the elastic model with the values assumed in the design, one can avoid nonlinear static (pushover) analysis. Schematic design, system selection, and even preliminary optimization can be done using only pencil and paper, avoiding the effort of developing detailed computer models.

The design approach presented here focuses on steel and reinforced concrete structural systems that do not have flexible diaphragms. Reinforced concrete design examples are provided herein; examples of the design of steel moment resistant frames using YPS are provided by Black and Aschheim (2000). Estimated values provided for initial proportioning presume fairly typical spatial distributions of lateral stiffness, strength, and mass; departures from typical distributions will increase the likelihood that design iterations will be needed. Systems with torsional irregularities and other important considerations (e.g., P-delta effects) addressed in Chapter 12 of the 2003 *NEHRP Recommended Provisions* are not addressed here nor are structural systems composed of materials other than steel and reinforced concrete and those using base-isolation or supplemental damping.

OVERVIEW OF DESIGN APPROACH

The design process is illustrated in Figure 2 and is described in detail in the sections that follow. An overview of the process and logic follows.

A structural system having a defined and desirable plastic mechanism is selected by the engineer. The required base shear strength, V_y , of this mechanism is determined to limit the peak roof displacement to an acceptable value considering interstory drift and system ductility limits. V_y is determined based on the corresponding ESDOF system using YPS. Estimates of the yield displacement, D_y , first-mode participation factor, Γ_1 , and first-mode mass coefficient, α_1 , are based on the type of structural system and number of stories. The base shear, V_y , is distributed over the height of the structure using an improved lateral force distribution. A simple plastic mechanism analysis is used to proportion the designated yielding members of the seismic-force-resisting system. A mathematical model of the structure is prepared and the calculated modal properties are used to assess the validity of the estimates D_y , Γ_1 , and α_1 and whether changes to the design base shear might be needed. The preceding steps establish the strength of the intended mechanism. Force-protected members then can be proportioned to ensure that the intended mechanism can develop, considering amplification due to higher modes and material overstrength.

DESIRABLE INELASTIC MECHANISMS

Current seismic design philosophies presume the development of desirable inelastic mechanisms with the concentration of inelastic deformation demands occurring at locations detailed for ductile response. Figure 3 illustrates desired mechanisms applicable to several common structural types. Once selected, the desired mechanism is used to determine the required strengths of the yielding portions of the seismic force-resisting system using a virtual work analysis.

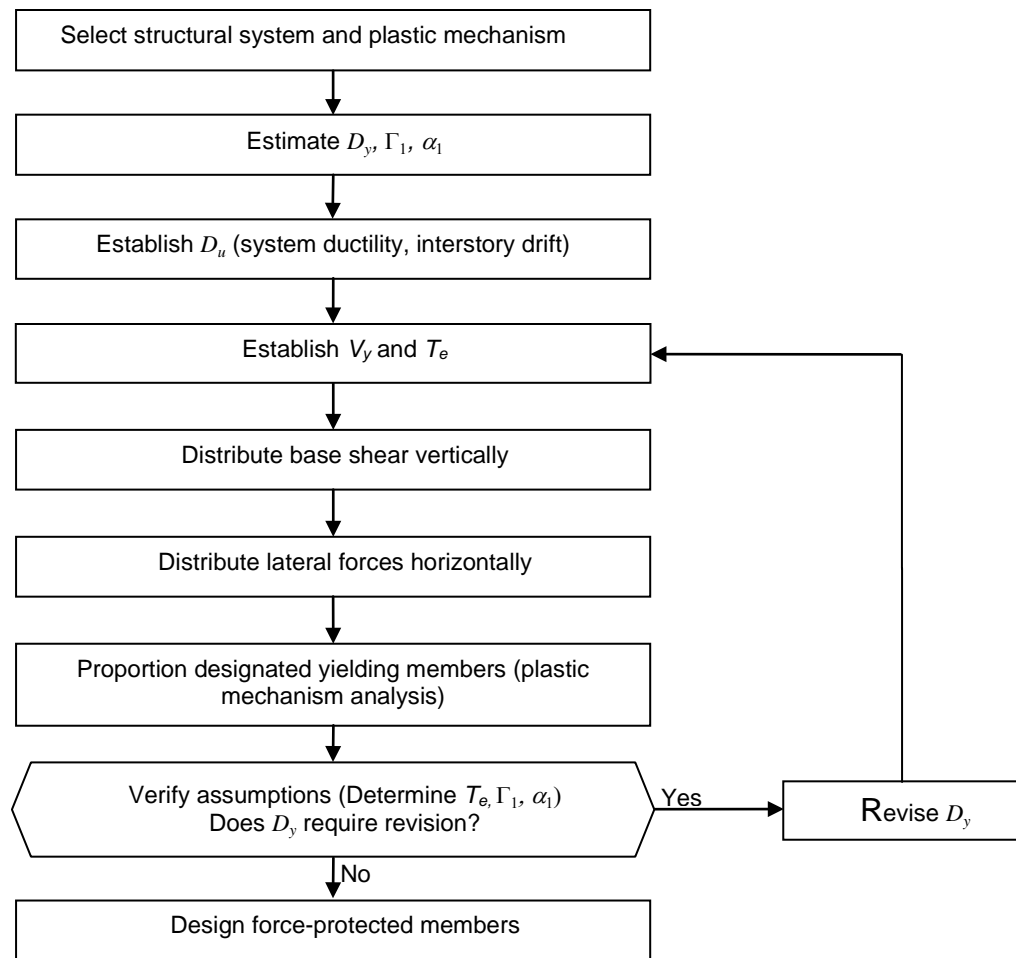

Figure 2 Steps in the design process.

ESTIMATES OF YIELD DISPLACEMENT

Nonlinear static or “pushover” analyses subject a model of a structure that includes nonlinear member force-deformation relationships to progressively increasing lateral forces. Of particular interest is the plot of base shear as a function of roof displacement obtained when lateral forces are proportional to the first mode (i.e., lateral force $F_{i,1}$ at the i^{th} floor level is proportional to the mode shape amplitude $\phi_{i,1}$ and weight, w_i). Such a plot is shown in Figure 4 for a four-story steel moment frame. The figure also shows a bilinear curve that has been fitted to approximately represent the initial stiffness and post-yield stiffness of the capacity curve. The breakpoint of the bilinear curve is known as the yield point, which defines the yield strength, V_y , and yield displacement, D_y .

Experience generally confirms the kinematic expectation that for any given structural system (distribution of mass, stiffness, and member depths), the yield displacement, D_y , determined in a pushover analysis varies with the yield strength of the steel members or reinforcement but is nearly independent of the strength of the system – that is, changes in strength achieved by increasing steel section weights or reinforcement percentages while maintaining member depths generally have a negligible influence on D_y (Priestley and Kowalsky, 1998; Priestley, 2000). Furthermore, the yield drift ratio (D_y normalized by the height of the structure) is nearly invariant with changes in the number of stories for a given structural system (e.g., Aschheim, 2000; Paulay, 2002). Thus, it is feasible to provide estimates of yield drift ratio to be used in design. The yield drift ratio

estimates can be used in much the same way that conventional seismic design approaches make use of period estimates. Periods of vibration, however, may vary significantly during design iterations whereas the yield displacement is fairly stable.

Estimates of the drift ratio at yield, D_y/h , for steel buildings using Grade 50 steel and for reinforced concrete buildings using Grade 60 reinforcement are given in Table 1.

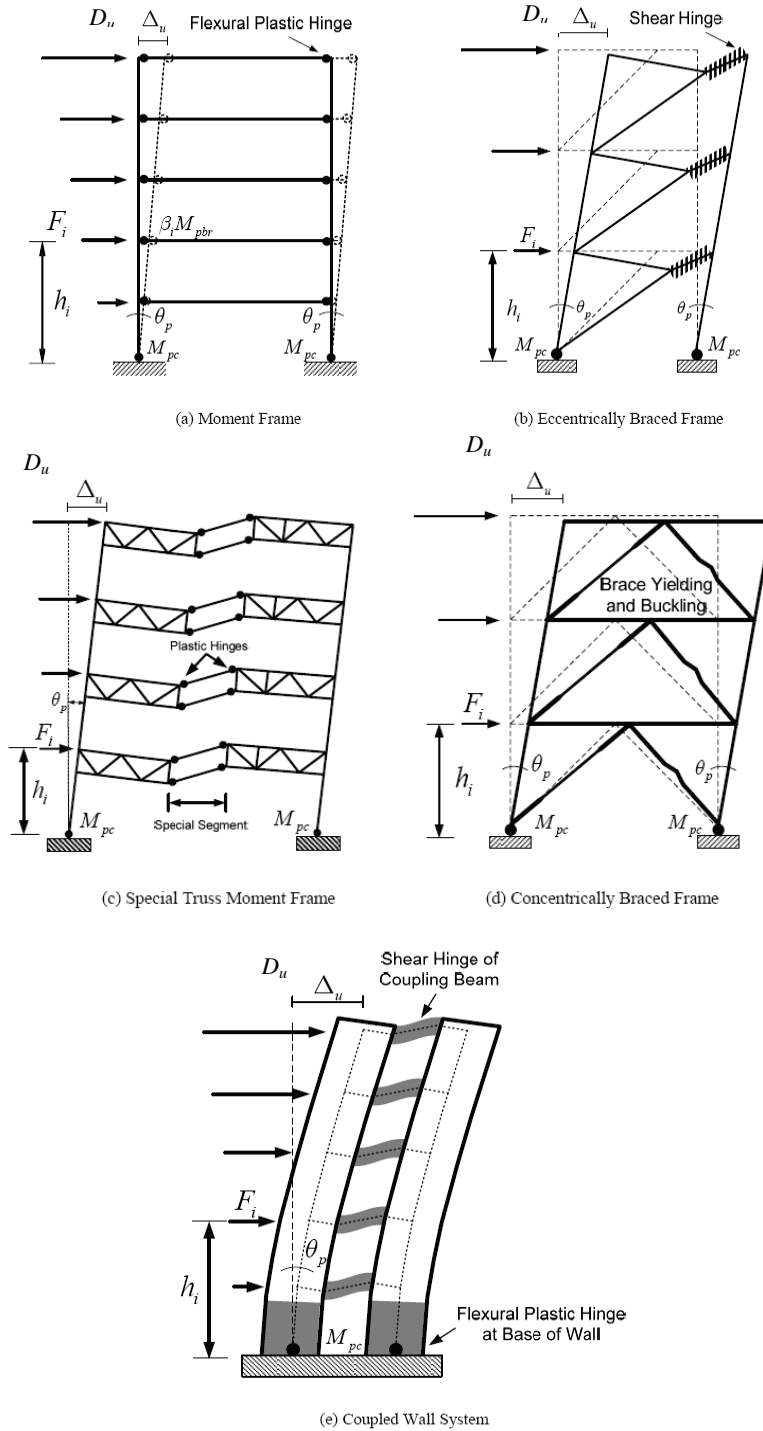

Figure 3 Desirable inelastic mechanisms.

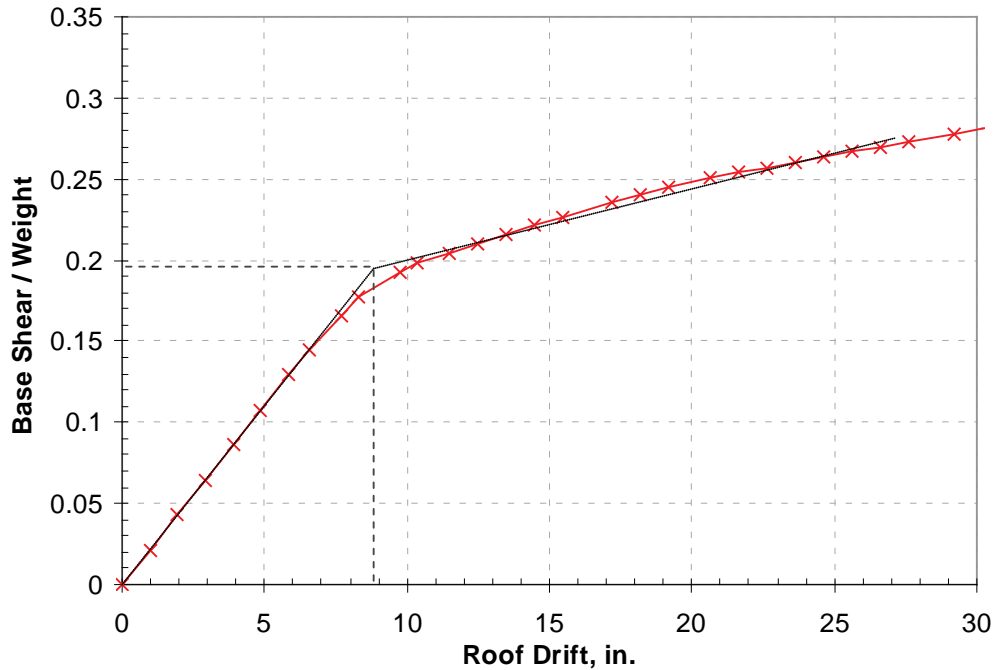

Figure 4 Capacity curve obtained from a nonlinear static (pushover) analysis.

Table 1 Yield Drift Ratio Estimates

Seismic-Force-Resisting System	Estimated Yield Drift Ratio, %
<i>Reinforced Concrete Buildings</i>	
Moment Frames	0.5 – 0.6
Cantilever Shear Walls ^a	0.10 h/l_w
<i>Steel Buildings</i>	
Moment Frames	1 – 1.2
Special Truss Moment Frames	0.75
Centrally Braced Frames	0.3
Eccentrically Braced Frames	0.5
Buckling Restrained Braced Frames	0.3 – 0.5

^aExpression is based on Tjhin et al. (2002).

Thus, the yield displacement for a building whose roof is at height h above the base is given as:

$$D_y = \left(\frac{D_y}{h} \right) h \quad (1)$$

These drift ratios are considered suitable for preliminary design purposes; however, more refined estimates may be available in specific cases. The influence of foundation flexibility on the yield displacement and required strength determination also may be addressed as described in the appendix to this paper.

DETERMINATION OF PEAK DISPLACEMENT FOR DESIGN

Peak displacement response is limited to prevent excessive interstory drift and system ductility demands as a means of protecting nonstructural elements and the seismic-force-resisting system from excessive damage.

While the influence of higher modes (or MDOF effects in the case of inelastic response) on peak roof displacement generally is small, higher modes may play a more prominent role in peak interstory drift demands, particularly for systems that deform in a “shear” mode (e.g., moment-resistant frames). In the equivalent lateral force procedure, limits on allowable story drift are compared with story drifts determined from an elastic analysis using statically applied lateral forces. Larger interstory drifts can be expected during dynamic response. Thus, a *Provisions*-compatible design approach would compare interstory drifts under a static quasi-first-mode pattern of lateral forces with tabulated allowable story drifts.

Values of a coefficient, $\alpha_{3,stat}$, are given in Table 2 for different structural systems as a function of the number of stories. This coefficient is an estimate of the ratio of the maximum interstory drift ratio over the height of the building to the average roof drift ratio under first-mode lateral forces. Thus, for design purposes, compliance with allowable story drifts is approximately (and constructively) achieved by limiting the peak roof drift to:

$$D_{u,\Delta} = \frac{\Delta_a}{h_{sx} \cdot \alpha_{3,stat}} h \quad (2)$$

where Δ_a is the allowable story drift from Table 12.12-1 of the 2003 *NEHRP Recommended Seismic Provisions*, h is the height of the roof level above the base, and h_{sx} is the parameter appearing in this table.

Table 2 Parameter Estimates

Number of Stories	Moment-Resistant Frames				Dual Shear Wall-Moment Frame Systems				Slender Cantilevered Shear Walls and Braced Frames			
	Γ_1	α_1	$h_{eff,v}/h$	$\alpha_{3,stat}$	Γ_1	α_1	$h_{eff,v}/h$	$\alpha_{3,stat}$	Γ_1	α_1	$h_{eff,v}/h$	$\alpha_{3,stat}$
1	1.00	1.00	1.00	1.00	1.00	1.00	1.00	1.00	1.00	1.00	1.00	1.00
2	1.21	0.94	0.79	1.19	1.24	0.89	0.81	1.00	1.24	0.76	0.86	1.38
3	1.27	0.90	0.73	1.23	1.33	0.85	0.75	1.00	1.35	0.70	0.81	1.49
5	1.32	0.86	0.70	1.26	1.40	0.82	0.71	1.00	1.46	0.66	0.78	1.58
10	1.35	0.82	0.67	1.28	1.45	0.79	0.69	1.00	1.54	0.63	0.75	1.64
≥ 20	1.37	0.80	0.66	1.29	1.48	0.77	0.68	1.00	1.59	0.62	0.74	1.67

Figure 5 conceptually illustrates the capacity curve and peak roof displacement for a structure responding in the first mode.

The coefficient Ω represents the true overstrength in contrast to the Ω_0 parameter specified in the 2003 *Provisions*. Coefficients C_1 , C_2 , α_1 , and Γ_1 are defined below. Relative to the effective yield point shown in Figure 5, the system displacement ductility, μ , is:

$$\mu = \frac{D_{u,\mu}}{D_y} = \frac{C_1 C_2 \Gamma_1 S_d}{\Gamma_1 S_d \left(\frac{\Omega I}{\alpha_1 R} \right)} = C_1 C_2 \alpha_1 \frac{R}{\Omega I} \quad (3)$$

Thus, an inference about the true overstrength coefficient, Ω , makes it possible to establish system ductility limits that are consistent with the R and Ω_0 values given in the *Provisions*.

System ductility limits (μ_c) were derived assuming $\Omega = \Omega_0$ for structures of ordinary importance ($I = 1.0$) assuming $C_1 = C_2 = 1.0$ and taking $\alpha_1 = 0.90$ for moment-resistant frames, 0.80 for eccentrically braced frames, and 0.65 for cantilever shear walls and concentrically braced frames. These values correspond approximately to the point at which ductility limits would be expected to control rather than drift. For structures with shorter periods, the consideration of short-period displacement amplification vis-à-vis the C_1 and C_2 coefficients in this design approach will result in better control of system ductility response than is achieved with the equivalent lateral force procedure because the latter uses period-independent R factors. System ductility limits derived with this approach are given in Table 3 and reflect ductility demands relative to the effective yield displacement, considering overstrength for design-level ground motions.

Modification of the system ductilities given in Table 3 for building importance is appropriate. Consequently, the design ductility limit, μ_d , is given as $\mu_d = \mu_c / I$ and

$$D_{u,\mu} = \mu_d \cdot D_y \quad (4)$$

Since either the drift limit or the ductility limit may be more restrictive, the target roof displacement used for design is given as:

$$D_u = \min(D_{u,\Delta}, D_{u,\mu}) \quad (5)$$

Consequently, the target ductility demand (considering interstory drift and system ductility limits) is given as:

$$\mu_t = \frac{D_u}{D_y} \quad (6)$$

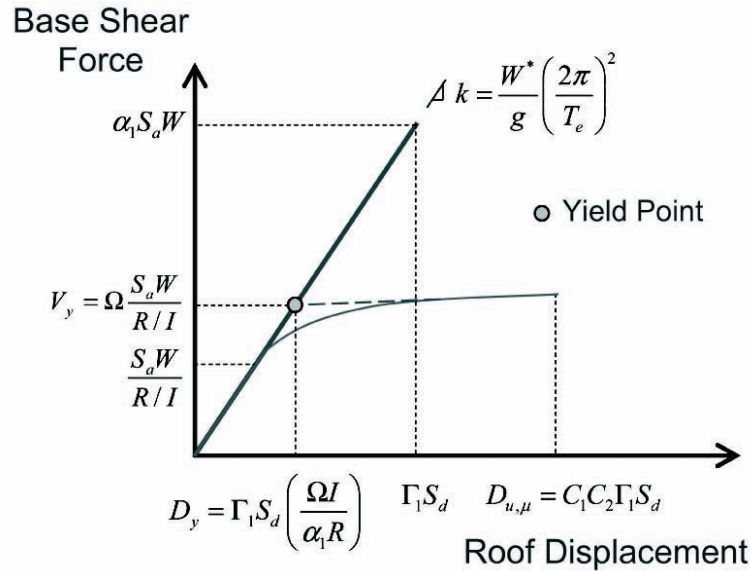

Figure 5 Response of elastic and yielding MDOF systems in the first mode. The “yield point” identifies the change in slope of a bilinear curve that is fitted to the capacity curve over the applicable range of displacement response. Ω represents the actual overstrength factor, not the value Ω_n provided in the 2003 NEHRP Recommended Seismic Provisions.

Table 3 System Ductility, μ_t , for Buildings of Ordinary Importance at Design Basis Level (2/3 of MCE Level per the 2003 Provisions)

Seismic Force-Resisting System	Special	Intermediate	Ordinary
<i>Concrete Frame Buildings</i>			
Moment Frames	2.4	1.5	0.9
Reinforced Cantilever Shear Walls	1.6	–	1.3
<i>Steel Frame Buildings</i>			
Moment Frames	2.4	1.4	1.1
Truss Moment Frames	2.1	–	–
Concentrically Braced Frames	2.0	–	1.1
Buckling-Restrained Braced Frames			
Moment-resisting connections at columns away from links		3.2	
Non-moment-resisting connections at columns away from links		2.8	
Eccentrically Braced Frames			
Non-moment-resisting beam-column connections		2.8	
With moment-resisting beam-column connections		2.6	

EQUIVALENT SDOF RELATIONSHIPS FOR MDOF SYSTEMS

Because the contribution of higher modes to roof displacement tends to be small, the required base shear strength to limit drift response is based on an equivalent SDOF model that reflects first-mode contributions. Thus, this section presents established relationships that allow MDOF properties to be mapped to ESDOF properties and vice versa.

An ESDOF system can be determined having seismic weight W^* and force and displacement quantities equal to those of the MDOF system divided by the first-mode participation factor, Γ_1 . Since the roof drift at yield, D_y , can be estimated as indicated above, the yield drift of the ESDOF oscillator can be estimated as:

$$D_y^* = \frac{D_y}{\Gamma_1} \quad (7)$$

where the asterisk (*) signifies a property of the ESDOF system. Estimates of Γ_1 are provided in Table 2.

Once a detailed mathematical model of the structure has been created, a precise value of Γ_1 can be computed. To do so, a modal analysis is performed and values of the first-mode shape $\phi_{i,1}$ at each level, i , are stored in a vector ϕ_1 , normalized such that the amplitude of the roof displacement equals 1. Weights w_i at each level, i , are stored in a diagonal matrix \mathbf{W} . Then, Γ_1 may be determined as:

$$\Gamma_1 = \frac{\phi_1^T \mathbf{W} \mathbf{1}}{\phi_1^T \mathbf{W} \phi_1} \quad (8)$$

where $\mathbf{1}$ is a vector of length n in which all entries are ones. Given the estimate of D_y^* from Equation 7, the strength of the ESDOF oscillator to limit its ductility demand to μ_y may be determined using YPS as $V_y^* = C_y^* W^*$. Since

$$V_y^* = \frac{V_y}{\Gamma_1}, \quad (9)$$

the required base shear strength for the MDOF system may be determined as:

$$V_y = V_y^* \cdot \Gamma_1 \quad (10)$$

However, knowing that $W^* = \phi_1^T \mathbf{W} \mathbf{1}$,

$$V_y = C_y W = V_y^* \cdot \Gamma_1 = C_y^* \cdot W^* \cdot \Gamma_1 = C_y^* \phi_1^T \mathbf{W} \mathbf{1} \left(\frac{W}{\mathbf{1}^T \mathbf{W} \mathbf{1}} \right) \Gamma_1 = \quad (11)$$

$$C_y^* \Gamma_1 \left(\frac{\phi_1^T \mathbf{W} \mathbf{1}}{\mathbf{1}^T \mathbf{W} \mathbf{1}} \right) W = C_y^* \alpha_1 W$$

since $W = \mathbf{1}^T \mathbf{W} \mathbf{1}$ and the first-mode mass coefficient, α_1 , can be defined in terms of weights as:

$$\alpha_1 = \frac{\phi_1^T \mathbf{W} \mathbf{1}}{\phi_1^T \mathbf{W} \phi_1} \cdot \frac{\phi_1^T \mathbf{W} \mathbf{1}}{\mathbf{1}^T \mathbf{W} \mathbf{1}} = \Gamma_1 \cdot \frac{\phi_1^T \mathbf{W} \mathbf{1}}{\mathbf{1}^T \mathbf{W} \mathbf{1}} \quad (12)$$

Equation 11 can be used to derive an expression that is quite simple to use in practice. Since the yield strength coefficient, C_y^* , can be determined directly from the design YPS, the base shear coefficient of the MDOF system can be determined simply as:

$$C_y = \alpha_1 C_y^* \quad (13)$$

Thus, the design base shear is given as:

$$V_y = C_y W \quad (14)$$

An initial estimate of α_1 may be obtained from Table 2, while a more precise value can be computed using Equation 12 after a detailed model of the structure has been developed and evaluated to determine the first-mode shape.

The period of vibration depends on the amount of strength provided to ensure the ESDOF oscillator has a ductility demand not exceeding μ_y . Having established the yield displacement, D_y^* , and the yield strength coefficient, C_y^* , of the ESDOF oscillator, the corresponding period of vibration, T^* , is given by:

$$T^* = 2\pi \sqrt{\frac{D_y^*}{C_y^* g}} \quad (15)$$

This period can be used in determining the lateral force distribution to be used in design and can be compared to the fundamental period of vibration determined for a detailed model of the structure, which may be affected by inaccuracy in the estimates of D_y , α_1 , and Γ_1 .

BASE SHEAR STRENGTH DETERMINATION

The response of inelastic oscillators has been the subject of academic inquiry since perhaps 1960. Peak displacement and peak ductility responses have been related to the peak response of companion elastic oscillators having the same initial stiffness. In recent work by the Applied Technology Council, the peak displacement of the SDOF oscillator is estimated as the product of the peak displacement of the companion elastic oscillator, S_d , and coefficients C_1 and C_2 that account separately for the effects of strength and degradation of strength and stiffness (FEMA 440, 2005). Since $S_d = S_a(T_e/2\pi)^2 g$, the peak displacement of the yielding oscillator, D_u^* , may be expressed as:

$$D_u^* = C_1 C_2 S_a \left(\frac{T_e}{2\pi} \right)^2 g \quad (16)$$

The effect of yield strength less than that required for elastic response on peak displacement response is represented by the coefficient, C_1 , which is evaluated as:

$$C_1 = 1 + \frac{R^* - 1}{a T_e^2} \quad (17)$$

where R^* = the ratio of the strength required for elastic response and the yield strength of the inelastic oscillator, T_e = period of vibration in seconds, and a is a parameter that varies with Site Class where a can be taken equal to 130 for Site Classes A and B, 90 for Site Class C, and 60 for Site Classes D, E, and F.

The effect of cyclic degradation of stiffness and strength on peak displacement response is represented by the coefficient C_2 . For T_e less than 0.7 sec, this coefficient is estimated by

$$C_2 = 1 + \frac{1}{800} \left(\frac{R^* - 1}{T_e} \right)^2 \quad (18)$$

For periods greater than 0.7 sec, C_2 may be taken equal to one. According to FEMA 440, the value of T_e used in Equations 17 and 18 need not be taken less than 0.2 sec.

YPS developed for a particular site by applying the above relationships to a design spectrum determined according to 11.4.5 are presented in Figure 6. The appendix of this paper presents background on the YPS representation of seismic demands.

Having determined D_y^* and μ_t , the required C_y^* can be determined by interpolation between the curves of constant μ shown in the YPS. For example, for $D_y^* = 12$ in. and $\mu_t = 1.7$ chosen somewhat arbitrarily, Figure 6 illustrates that the required ESDOF base shear coefficient, C_y^* , is approximately 0.37. The expected peak displacement of the ESDOF system is $D_u^* = \mu D_y^* = 1.7(12 \text{ in.}) = 20.4$ in. Using Equation 15, the period of vibration of the ESDOF oscillator is:

$$T^* = 2\pi \sqrt{\frac{D_y^*}{C_y^* g}} = 2\pi \sqrt{\frac{12 \text{ in}}{0.37 \cdot 386.1 \text{ in/sec}^2}} = 1.82 \text{ sec}$$

Having estimated α_1 and Γ_1 , the peak roof displacement and required base shear strength at yield for the multi-degree-of-freedom system can be estimated as $D_u = \mu_t D_y = \mu_t (\Gamma_1 D_y^*)$ and $V_y = C_y^* (\alpha_1 W)$, respectively.

Note that it is not necessary to construct admissible design regions when working with a specific value of D_y^* ; whether drift or ductility limits control will be apparent in the determination of μ_t .

DISTRIBUTION OF LATERAL FORCES FOR DESIGN

Because dynamic response indicates story shears in multistory buildings differ significantly from those associated with the equivalent lateral force procedure of the *Provisions*, a new lateral force distribution has been recommended (Chao et al., 2007). This lateral force distribution more closely corresponds to the peak shears observed in nonlinear dynamic response. This distribution is characterized by the parameter β_i . In this paper, β_i is used to represent the ratio of the story shear, V_i , just below Level i , and the base shear, V_y , corresponding to the effective yield strength, as follows:

$$\beta_i = \frac{V_i}{V_y} = \left(\frac{\sum_{j=i}^n w_j h_j}{\sum_{j=1}^n w_j h_j} \right)^{\frac{\alpha}{T_e^{0.2}}} \quad (19)$$

where story weights, w_j , and story heights, h_j , are defined as w_i and h_i , respectively, in the *Provisions*, V_y = effective yield strength, and $\alpha = 0.75$. Thus, the equivalent lateral force applied at Level i , $F_{i,\beta}$, is given by:

$$F_{i,\beta} = (\beta_i - \beta_{i+1}) \cdot V_y \quad (20)$$

where $\beta_{n+1} = 0$.

The intended mechanism may yield in response to the overturning moments or the story shears developed by the lateral forces and deformations. Many systems (e.g., moment frames and shear walls) yield in response to the overturning moments (associated with the lateral forces acting above the base of the structure) developed during response. Other systems (e.g., braced frames) yield in response to the story shears developed by the lateral forces.

The $F_{i,\beta}$ distribution of forces generally increases the story shears in the upper stories relative to the first-mode distribution of forces and many code force distributions.

The design base shear at yield determined in Equation 14 on the basis of the first-mode is adequate to limit roof displacement response of the MDOF system. Higher mode (or MDOF) effects have a relatively minor contribution to displacement response but can have a significant contribution to interstory drifts and story shears and lead to design forces represented by the $F_{i,\beta}$ distribution.

For those systems that yield in response to overturning moments, distribution of the base shear determined on the basis of first-mode response over the height of the structure according to the $F_{i,\beta}$ distribution generally will increase the overturning resistance of the structure above that required to limit displacement response. For this reason, the base shear used in conjunction with Equations 19 and 20 must be modified for those systems that yield in response to the overturning moments (e.g., moment frames and shear walls). The modified base shear is given by $V_y \cdot (h_{eff,1}/h_{eff,\beta})$ where V_y is determined using Equation 14, $h_{eff,1}$ is the height of the resultant of the first-mode forces, and $h_{eff,\beta}$ is the height of the resultant of the β_i lateral forces. Table 2 provides estimates of $h_{eff,1}/h$.

MECHANISM-BASED DETERMINATION OF MEMBER STRENGTHS

A plastic mechanism analysis may be used to determine member strengths as described by Goel and Chao (2007). As shown in Figure 3, the vertical distribution of story strengths (or plastic hinge strengths) may be made proportional to β_i . Doing so appears to promote a number of desirable effects, including limiting the column moments obtained in a static (design) analysis during the development of a mechanism (by providing inflection points within each story) and making the distribution of peak interstory drifts observed in nonlinear dynamic analyses more uniform over the height of the structure than is obtained with conventional designs (e.g., Goel et al., 2007).

Thus, with reference to Figure 3, a virtual work analysis may be used to determine member strengths required to provide the seismic-force-resisting system with the required base shear strength. For example, considering a moment frame, the reference plastic moment strength, M_{pbr} , may be determined by Equation 21 if beam plastic hinge strengths at the i^{th} level are assigned the value $\beta_i \cdot M_{pbr}$. Equating external work and internal work leads to:

$$\sum_{i=1}^n F_{i,\beta} h_i \theta_p = V_y h_{eff,\beta} \theta_p = 2M_{pc} \theta_p + \sum_{i=1}^n \beta_i M_{pbr} \theta_p \quad (21)$$

which may be solved for M_{pbr} once the column plastic hinge strengths at the base of the frame have been established. The column plastic hinge strengths should be established to provide a sufficient margin against the development of a weak-story mechanism. For example, using a factor of 1.1, the column plastic hinge strengths for a one-bay frame would be determined as:

$$M_{pc} = 1.1 \frac{V_b \cdot h_1}{4} \quad (22)$$

based on the intention that a weak-story mechanism at this location be avoided. Equation 21 may then be solved for the M_{pbr} ; beam plastic moments at each level are determined as $\beta_i \cdot M_{pbr}$.

DESIGN VALIDATION/REFINEMENT

After members have been sized, a mathematical model of the structure can be developed and evaluated. A nonlinear static (pushover) analysis in the first mode may be performed to evaluate the yield point of the MDOF system and establish a more accurate ESDOF system for use in estimating the expected peak displacement and corresponding system ductility demands. However, nonlinear static analysis can be avoided entirely for structural systems that do not soften or crack prior to the onset of yield—in such cases, elastic analysis results may be used to validate the performance of a preliminary design and to identify refinements when necessary.

As illustrated in Figure 5, the yield point may be estimated based on the actual stiffness and strength provided to the structure. The strength of the system is the design base shear at yield (Equation 14) or the plastic strength obtained in a mechanism analysis under the $F_{i,\beta}$ force distribution modified by $(h_{eff,1}/h_{eff,\beta})$. The first-mode period, T_e , reflects the actual initial stiffness, and this period can be obtained from an eigenvalue analysis of the elastic model (provided that softening or cracking of the structure does not occur prior to the onset of yield). An improved estimate of the yield displacement of the MDOF model can be determined for such systems. Because the initial stiffness of the capacity curve is given by $(W^*/g)(2\pi/T_e)^2$, the improved estimate of the yield displacement is given by:

$$D'_y = \frac{V_y}{W^*/g} \left(\frac{T_e}{2\pi} \right)^2 \quad (23)$$

where $W^* = \phi_1^T \mathbf{W} \mathbf{1}$ should be computed using the first-mode shape obtained for the mathematical model of the structure (with entries normalized such that the roof displacement amplitude equals one). Since the modal parameter Γ_1 can be determined for the mathematical model, the yield point of the ESDOF oscillator (D_y/Γ_1 , V_y/Γ_1) can be plotted on the YPS in order to make a more precise estimate of the ductility demand and peak roof displacement. If these values are within the design limits, the design is considered acceptable. If it should be necessary to reduce the ductility demand, revision of the required strength may be determined based on the improved estimate of yield displacement (D'_y/Γ_1) and using modal parameters determined for the first-mode properties of the mathematical model.

With some experience, however, comparison of T_e with the period of the ESDOF system, T^* , can provide a sufficient basis for evaluating the adequacy of the preliminary design. As indicated by Equation 15, a longer period indicates the yield point has shifted to the right leading to lower ductility demands but higher drifts for a given strength (consider Figures 1 and 6). In contrast, a shorter period indicates the yield point has shifted to the left leading to higher ductility demands but lower drifts for a given strength. Provided that the estimates of α_1 and Γ_1 are reasonably accurate, comparison of periods may be sufficient to assess whether refinement of the preliminary design is needed.

Softening and/or cracking prior to yielding would be anticipated for reinforced concrete systems. If these effects are represented in the mathematical model of the structure (for example, due to gravity loads pre-compressing reinforced concrete members that may have been modeled with zero tensile strength), then the initial period of the model cannot characterize the effective stiffness or period at yield. In such cases, the fundamental period of vibration determined at small displacements, T_1 , should be modified to obtain an effective period of vibration (T_e) associated with the effective yield point observed in a nonlinear static (pushover) analysis using first-mode lateral forces.

Estimation of the effective period, T_e , is illustrated in the reinforced concrete wall example below.

DESIGN OF CAPACITY-PROTECTED MEMBERS

This paper focuses on the design of the designated yielding members of the seismic-force-resisting system. Force-protected members or actions include axial forces in collectors and the shears in slender structural walls. Amplification due to higher modes (or MDOF effects) and member overstrength should be considered for the design of members (or actions) that must remain elastic to ensure development of the intended mechanism.

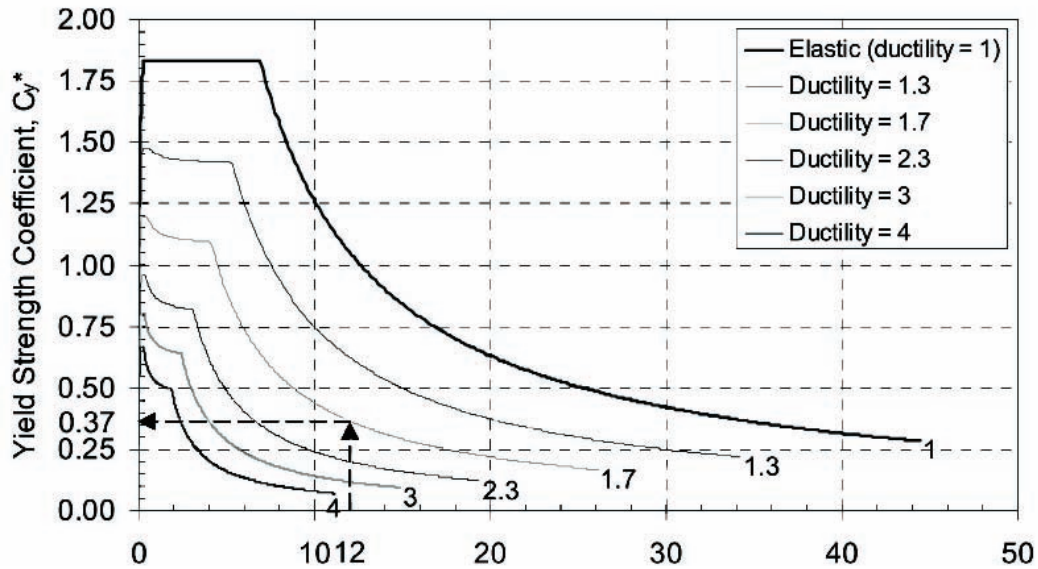

Figure 6 Yield point spectra.

REINFORCED CONCRETE WALL BUILDING EXAMPLE 1

A special reinforced concrete structural wall system was designed to provide lateral force resistance to a six-story reinforced concrete building. Four 20-foot long walls (labeled W1 in the plan of Figure 7) were designed. Story heights of 12 feet and dead loads of 175 psf were assumed; design live loads were 50 psf. Lumped masses at the floors and roofs were assumed uniform over the height of the building. Full dead load plus 20 percent of the live load was assumed present during seismic loading. For purposes of defining site seismicity, the example building was assumed to be located in Sacramento, California (in the 95837 Zip Code) on Site Class D soils according to the 2003 NEHRP Recommended Seismic Provisions.

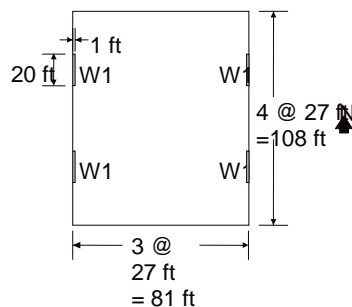

Figure 7 Reinforced concrete wall building plan.

The preliminary design was developed as follows:

1. Based on Table 1, the yield drift ratio was estimated as $0.10(h/l_w) = 0.10(72 \text{ ft})/(20 \text{ ft}) = 0.36$ percent. Therefore, the yield drift (at the roof level, corresponding to effective yield in a first-mode pushover analysis) is estimated as $D_y = (0.36\%)(h) = (0.0036)(72 \text{ ft})(12 \text{ in./ft}) = 3.11$ in.
2. From Table 2, the first-mode participation factor, Γ_1 , is estimated to be 1.47. Therefore, the yield drift of the “equivalent” SDOF oscillator is estimated as $D_y^* = D_y/\Gamma_1 = 3.11/1.47 = 2.12$ in.
3. A limit on displacement ductility is established by considering drift and system ductility limits.

From Table 3, the allowable system ductility for a special reinforced concrete cantilever shear wall system is 1.6. Therefore, the peak displacement limit based on the allowable ductility is $D_{u,\mu} = 1.6(3.11 \text{ in.}) = 4.98$ in.

The allowable story drift, obtained from Table 4.5-1 of the 2003 *NEHRP Recommended Provisions*, is $0.020h_{sx} = 0.020(12 \text{ ft})(12 \text{ in./ft}) = 2.88 \text{ in.}$ Table 2 provides an estimate of $\alpha_{3,stat} = 1.59$. Therefore, the roof drift limit associated with the allowable story drift is approximately $(0.020/1.59)(72 \text{ ft})(12 \text{ in./ft}) = 10.87 \text{ in.}$

The more restrictive of the two roof displacement limits governs the design. In this case, $D_{u,\mu} = 4.98 \text{ in.}$, and $\mu_t = D_{u,\mu}/D_y = (4.98 \text{ in.})/(3.11 \text{ in.}) = 1.6$.

- To determine the required yield strength coefficient, YPS are prepared for the design basis ground motion (Figure 8). For $D_y^* = 2.12 \text{ in.}$ and $\mu_t = 1.6$, the minimum base shear coefficient (at yield) is given by $C_y^* = 0.19$. Using $\alpha_1 = 0.65$ from Table 2, the required base shear strength coefficient (at yield) for the MDOF system is given by $C_y = \alpha_1 C_y^* = 0.65(0.19) = 0.124$.

The expected fundamental period of vibration of the building, based on the assumed yield displacement and modal parameters α_1 and Γ_1 , is $T_e = 2\pi(D_y^*/(C_y^*g))^{0.5} = 2\pi[2.12 \text{ in.}/(0.19 \cdot 386.1 \text{ in./sec}^2)]^{0.5} = 1.07 \text{ sec.}$

- Since there are four walls, the base shear strength (at yield) required for each wall for response in the first mode is given by $V_y = C_y \cdot W/4 = 0.124(2296 \text{ kips}) = 285 \text{ kips.}$
- Because the $F_{i,\beta}$ distribution of lateral forces has a resultant that generally acts at a location that differs from that of the first-mode distribution, the base shear is adjusted so that the flexural strength of the wall is equal to the product of V_y (= 285 kips) and the height of the resultant of the first-mode lateral forces. The $F_{i,\beta}$ distribution is determined using $T = 1.07 \text{ sec}$ as given in Table 4. The effective height of the resultant lateral force is given by $h_{eff,\beta} = \Sigma F_i h_i / \Sigma F_i = 15,909 \text{ k-ft} / 285 \text{ kips} = 56.41 \text{ ft.}$ Then, $h_{eff,\beta}/h = 56.41 \text{ ft} / 72 \text{ ft} = 0.784$. Since the first mode is estimated to have $h_{eff,1}/h = 0.77$, the adjusted base shear is $V_y = (285 \text{ kips})(0.77/0.784) = 280 \text{ kips.}$
- The wall is designed using the β_i distribution (Table 4) of lateral forces for a base shear of 280 kips. The required strength at the base of the wall is $M_n = (280 \text{ kips})(0.784)(72 \text{ ft})(12 \text{ in./ft}) = 190,000 \text{ kip-in.}$ The wall shown in Figure 9 has a nominal strength of 197,000 kip-in when subjected to a compressive force associated with its tributary gravity load, using Grade 60 reinforcement and $f'_c = 5 \text{ ksi.}$

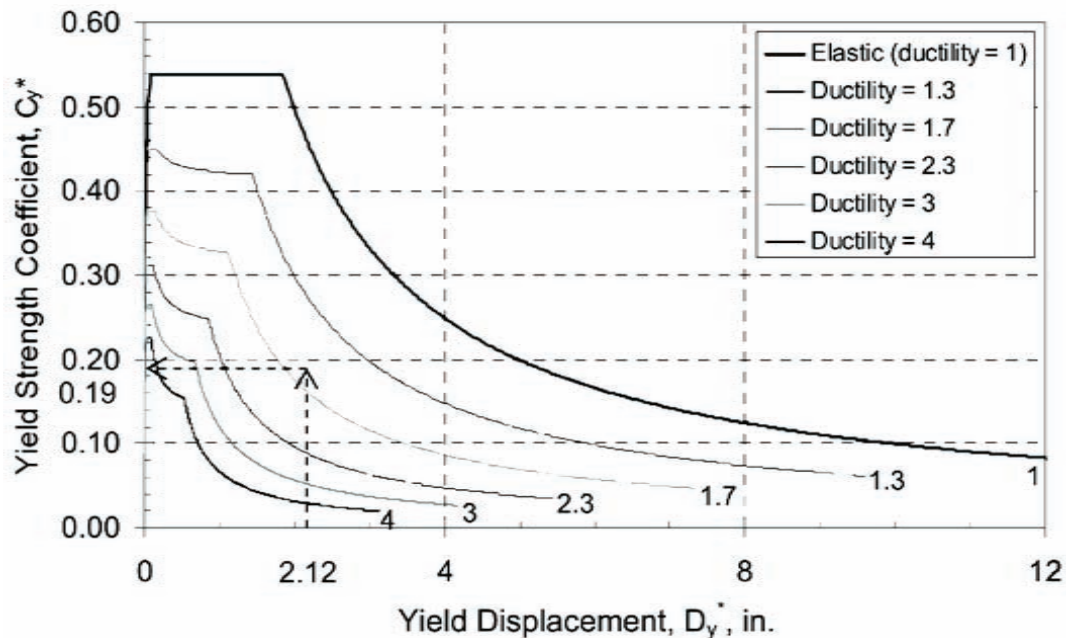

Figure 8 YPS used in the wall building example.

Table 4 Lateral Force Distribution for Reinforced Concrete Wall Example

Level	h_i (ft)	w_i (kips)	$w_i h_i$ (k-ft)	$\Sigma w_i h_i$ (k-ft)	$\beta_i = V_i/V_y$	$F_{i,\beta}/V_y$	$F_{i,\beta}$ (kips)	$F_{i,\beta} h_i$ (k-ft)
6	72	383	27,554	27,554	0.396	0.396	112.0	8,064
5	60	383	22,962	50,516	0.620	0.224	63.4	3,803
4	48	383	18,370	68,886	0.780	0.160	45.2	2,172
3	36	383	13,777	82,663	0.892	0.113	31.9	1,147
2	24	383	9,185	91,848	0.965	0.072	20.5	491
1	12	383	4,592	96,440	1.000	0.035	10.0	120
			Σ		4.652	1.000	285.0	15,909

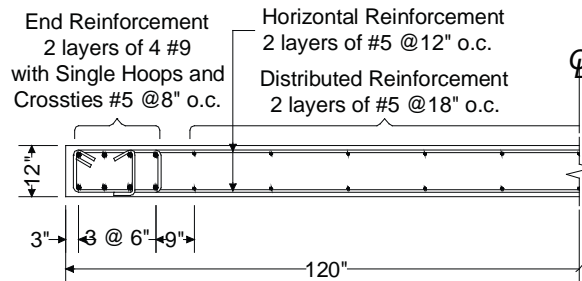

Figure 9 Section at the base of the reinforced concrete wall.

To further substantiate the design approach, a first-mode pushover analysis of the wall was conducted. The wall was modeled in Drain-2DX (Prakash et al., 1993) using a fiber element. Materials were modeled using their nominal strengths; strain hardening of reinforcement was included in the model. Modal properties used to establish the lateral force distribution for the pushover analysis are based on initial (uncracked) properties. The resulting capacity curve is shown in Figure 10. A bilinear curve was fitted to the capacity curve. The yield point (D_y, V_y) is given by (3.08 in, 288 kips), which is very close to the estimate of (3.11, 280 kips) that was used as a basis for the design.

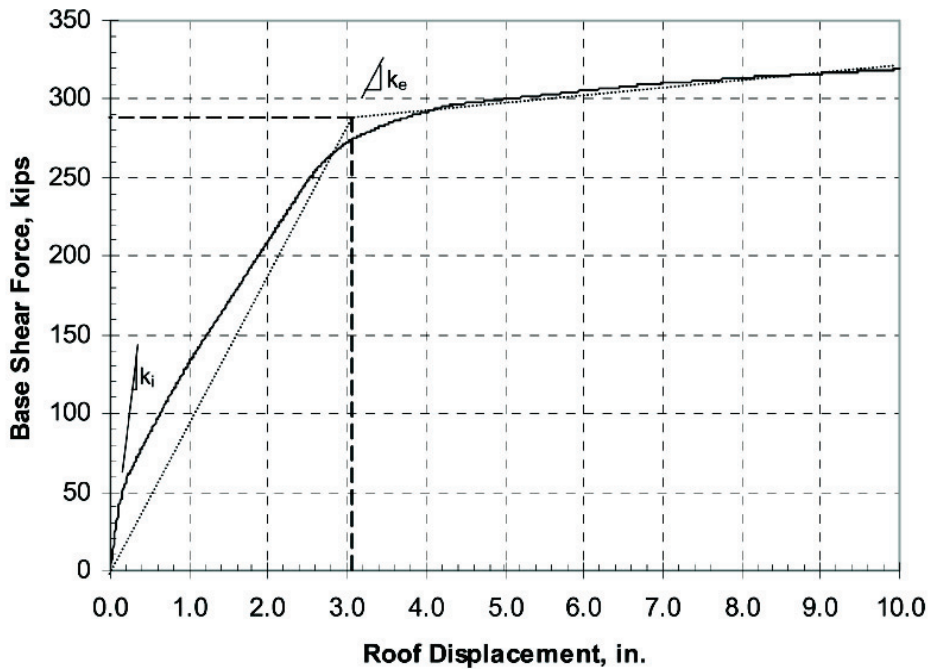

Figure 10 Capacity curve obtained in the pushover analysis of a wall.

The first-mode mass participation factor, based on uncracked sections, is 0.667, and the actual $h_{eff,1}/h$ is 0.806. The initial period based on uncracked sections, $T_{1,2}$ is 0.524 sec. The effective period may be determined as $T_e = T_i(k_i/k_e)^{0.5} = 0.524(385/93.5)^{0.5} = 1.06$ sec where $k_e = V_y/D_y = 288$ kips/3.08 in = 93.5 k/in. Because 1.06 sec is approximately equal to the ESDOF period (1.07 sec), the initial design is deemed adequate.

REINFORCED CONCRETE FRAME BUILDING EXAMPLE 2

A six-story special reinforced concrete moment frame was designed for a building having the same nominal floor plan and loading as the reinforced concrete wall example. Figure 11 shows a plan view. Story heights of 12 feet and dead and live loads of 175 and 50 psf, respectively, were assumed. This example building was also located in Sacramento, California, on Site Class D soils.

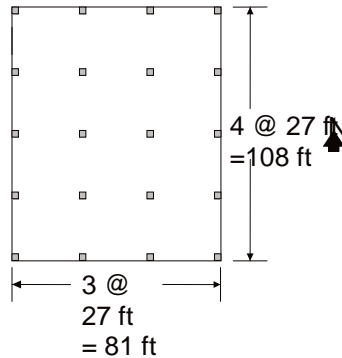

Figure 11 Plan view of reinforced concrete frame building.

The preliminary design was developed as follows:

1. Assuming from Table 1 that the yield drift ratio of the reinforced concrete moment frame is approximately 0.55 percent, the yield drift (at the roof level, corresponding to effective yield in a first-mode pushover analysis) was estimated as $D_y = (0.55\%)(h) = (0.0055)(72 \text{ ft})(12 \text{ in./ft}) = 4.75$ in.
2. From Table 2 the first-mode participation factor, Γ_1 , was estimated to be 1.33. Therefore, the yield drift of the “equivalent” SDOF oscillator was estimated as $D_y^* = D_y/\Gamma_1 = 4.75/1.33 = 3.57$ in.
3. A limit on displacement ductility was established by considering drift and system ductility limits. From Table 3, the allowable system ductility for a special reinforced concrete moment frame is 2.4. Therefore, the peak displacement limit based on the allowable ductility is $D_{u,\mu} = 2.4(4.75 \text{ in.}) = 11.4$ in. The allowable story drift, obtained from Table 4.5-1 of the 2003 *NEHRP Recommended Provisions*, is $0.020h_{sx} = 0.020(12 \text{ ft})(12 \text{ in./ft}) = 2.88$ in. Table 2 provides an estimate of $\alpha_{3,stat} = 1.26$. Therefore, the roof drift limit associated with the allowable story drift is approximately $(0.020/1.26)(72 \text{ ft})(12 \text{ in./ft}) = 13.71$ in. The more restrictive of the two roof displacement limits governs the design. In this case, $D_{u,\mu} = 11.4$ in., and $\mu_t = D_u/D_y = (11.4 \text{ in.})/(4.75 \text{ in.}) = 2.4$.
4. To determine the required yield strength coefficient, YPS were prepared for the design basis ground motion (Figure 12). For $D_y^* = 3.57$ in. and $\mu_t = 2.4$, the minimum base shear coefficient (at yield) is given by $C_y^* = 0.048$. Using $\alpha_1 = 0.85$ from Table 2, the required base shear strength coefficient (at yield) for the MDOF system was determined to be $C_y = \alpha_1 C_y^* = 0.85(0.048) = 0.0408$. The expected period of vibration is $T_e = 2\pi [D_y^*/(C_y^* g)]^{0.5} = 2\pi [3.57 \text{ in.}/(0.048 \cdot 386.1 \text{ in./sec}^2)]^{0.5} = 2.76$ sec.
5. If four separate moment frames provide resistance to lateral forces, the base shear strength (at yield) required for each frame for response in the first mode is given by $V_y = C_y \cdot W/4 = 0.0408(2296 \text{ kips}) = 93.7$ kips.
6. Because the $F_{i,\beta}$ distribution of lateral forces has a resultant that generally acts at a location that differs from that of the first-mode distribution, the base shear was adjusted so that the strength of the mechanism under the lateral forces corresponds to the overturning moment generated by the first-mode lateral forces over the height of the structure. The $F_{i,\beta}$ distribution was determined using $T_e = 2.76$ sec as given in Table 5. The effective height of the resultant lateral force is given by $h_{eff,\beta} = \Sigma F_i h_i / \Sigma F_i = 5433 \text{ k-ft} / 93.7 \text{ kips} = 57.98 \text{ ft}$ for a period of 2.76 sec. Then, $h_{eff,\beta}/h = 57.98 \text{ ft} / 72 \text{ ft} = 0.805$. Since the first mode is estimated to have $h_{eff,1}/h = 0.69$, the adjusted base shear is $V_y = (93.7 \text{ kips})(0.69/0.805) = 80.3$ kips.

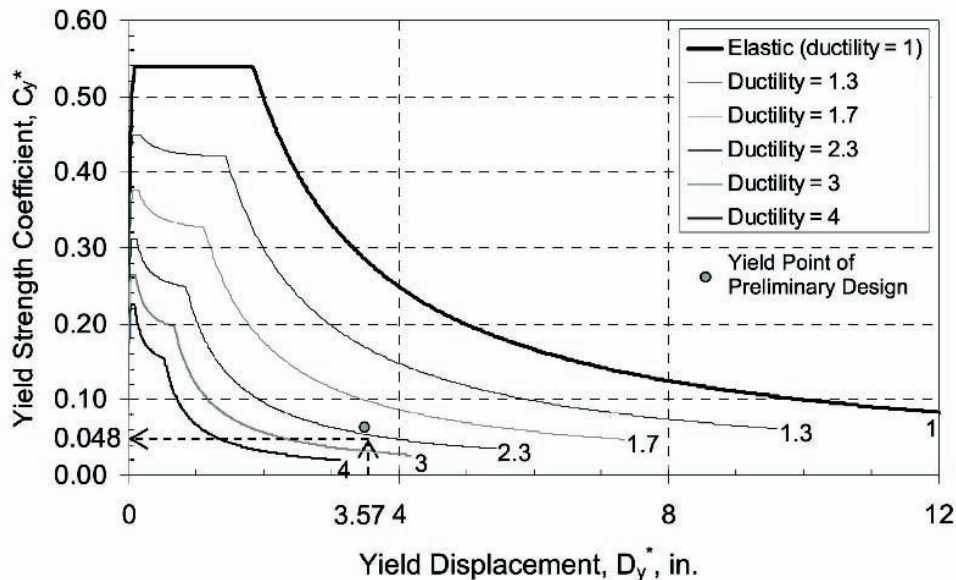

Figure 12 YPS used in the reinforced concrete frame example.

Table 5 Lateral Force Distribution for Reinforced Concrete Frame Example

Level	h_i (ft)	w_i (kips)	$w_i h_i$ (k-ft)	$\Sigma w_i h_i$ (k-ft)	$\beta_i = V_i/V_y$	$F_{i,\beta}/V_y$	$F_{i,\beta}$ (kips)	$F_{i,\beta} h_i$ (k-ft)
6	72	383	27,554	27,554	0.464	0.464	43.52	3133
5	60	383	22,962	50,516	0.673	0.209	19.55	1173
4	48	383	18,370	68,886	0.814	0.141	13.19	633
3	36	383	13,777	82,663	0.910	0.096	9.00	324
2	24	383	9,185	91,848	0.971	0.061	5.68	136
1	12	383	4,592	96,440	1.000	0.029	2.76	33
				Σ	4.832	1.000	93.70	5433

- The frame was designed using the $F_{i,\beta}$ distribution (Table 5) of lateral forces for a base shear of 80.3 kips. The first story column strengths were determined to prevent a story mechanism using Equation 22. Nominal column strengths at the base had to exceed $1.1(80.3 \text{ kips})(12 \text{ ft})/4 = 265 \text{ k-ft}$. Beam plastic hinge strengths (taken equal to the ACI nominal moment value using specified material properties) were distributed vertically in proportion to the β_i values given in Table 5. Thus, a virtual work calculation considering the mechanism of Figure 3a provides that external work, W_E , is given by $W_E = (80.3 \text{ kips})(57.98 \text{ ft})\theta_p$ and internal work, W_I , is given by $W_I = 2M_{pc}\theta_p + \Sigma(V_i/V_y)M_{pbr}\theta_p = 2(265 \text{ k-ft})\theta_p + 4.832(M_{pbr})(2)\theta_p$ where M_{pbr} is a reference plastic strength. Setting $W_E = W_I$ results in $M_{pbr} = 428 \text{ k-ft}$.
- Conventional reinforced concrete frame details provide a positive moment capacity at the face of a joint that is equal to at least one-half the negative moment capacity. To provide sufficient strength to the mechanism, the strengths at opposite ends of the beam ($M_p^+ + M_p^-$) must equal or exceed $2\beta_i M_{pbr}$ at the i^{th} floor level. In the present example, 20 percent of the live load is considered to be present together with 100 percent of the dead load. Load factors used in a routine design would lead to unused gravity moment capacity that would contribute to strength and stiffness during seismic loading and, hence, would increase the lateral strength and reduce the modal periods of the frame.

To avoid incurring these beneficial effects in the example, which both illustrates the design approach and demonstrates its robustness, only dead loads and 20 percent of the live load were considered in combination with the seismic demands to determine M_p^- . Then, M_p^+ was set equal to $0.5(M_p^-)$. Reinforcement steel was proportioned assuming $M_n = M_p^-$.

The resulting cross sections are shown in Figure 13. Grade 60 reinforcement and concrete having $f'_c = 5 \text{ ksi}$ were used in the design and the mathematical models.

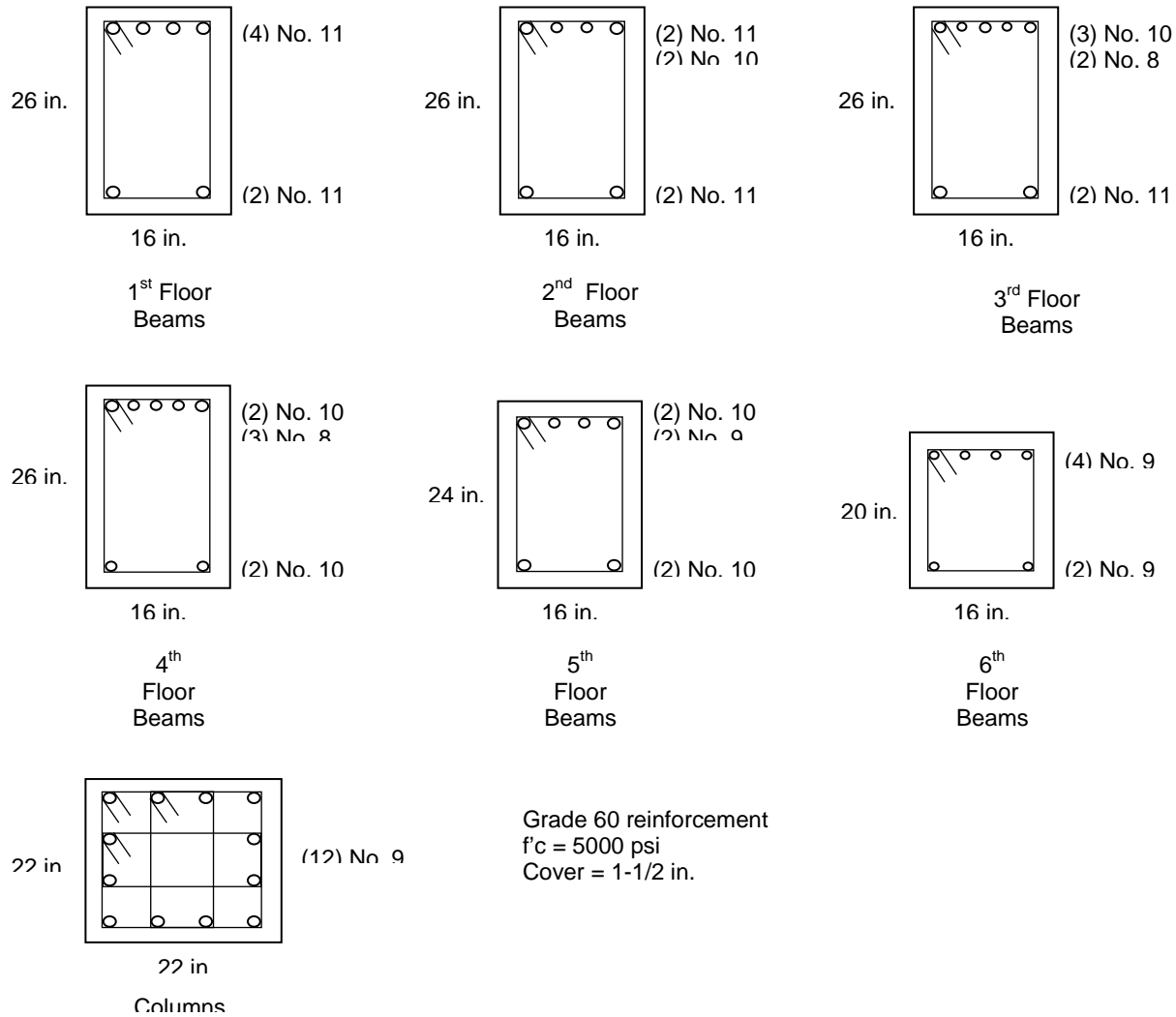

Figure 13 Beam and column section designed in the reinforced concrete frame example.

To validate the assumptions used in the design, a first-mode pushover analysis of a frame was conducted. The frame was modeled in Drain-2DX (Prakash et al., 1993) using fiber elements. Rigid end offsets were used at the joints. Materials were modeled using their nominal strengths; strain hardening of reinforcement was included in the model. Modal properties used to establish the lateral force distribution for the pushover analysis are based on initial (uncracked) properties. The resulting capacity curve is shown in Figure 14. A bilinear curve was fitted to the capacity curve. The yield point (D_y , V_y) is given by (4.85 in., 104 kips), which is in the vicinity of the estimate of (4.75 in, 93.7 kips) that was used as a basis for the design. The higher lateral strength obtained in the pushover analysis is attributed to: (1) reinforcement provided to the beams resulted in beam plastic moment strengths that were slightly greater than the strengths determined in the mechanism analysis; (2) flexural strength provided to resist tributary gravity loads was mobilized in the pushover analysis; and (3) the mechanism analysis was based on centerline dimensions, but the use of rigid end offsets caused the plastic hinges to form at or near the faces of the beam-column joints, thereby increasing the shears associated with flexural hinging.

The first-mode participation factor determined for the mathematical model is 1.37 and the mass participation factor is 0.742, based on uncracked sections. The actual $h_{eff,1}/h$ is 0.751. These values are all close to those assumed for the preliminary design (1.33, 0.85, and 0.69, respectively). The fundamental period of vibration is 2.43 sec, which is significantly less than the 2.76 sec assumed in the design. Thus, an evaluation of the preliminary design is warranted.

The yield strength coefficient is computed as $C_y = V_y/W = (104 \text{ kips})/(2296 \text{ kips}) = 0.0453$, and $C_y^* = C_y/\alpha_1 = 0.0453/0.742 = 0.061$. Noting that $D_y^* = 4.85/1.37 = 3.54$ in., one may determine from Figure 12 an expected ductility demand $\mu = 2.2$.

Thus, system ductility demands are acceptable and the expected peak displacement $= \mu D_y = 2.2(4.85 \text{ in.}) = 10.7 \text{ in.}$ is less than the 13.71 in. limit that was established based on allowable story drifts. The design is considered satisfactory.

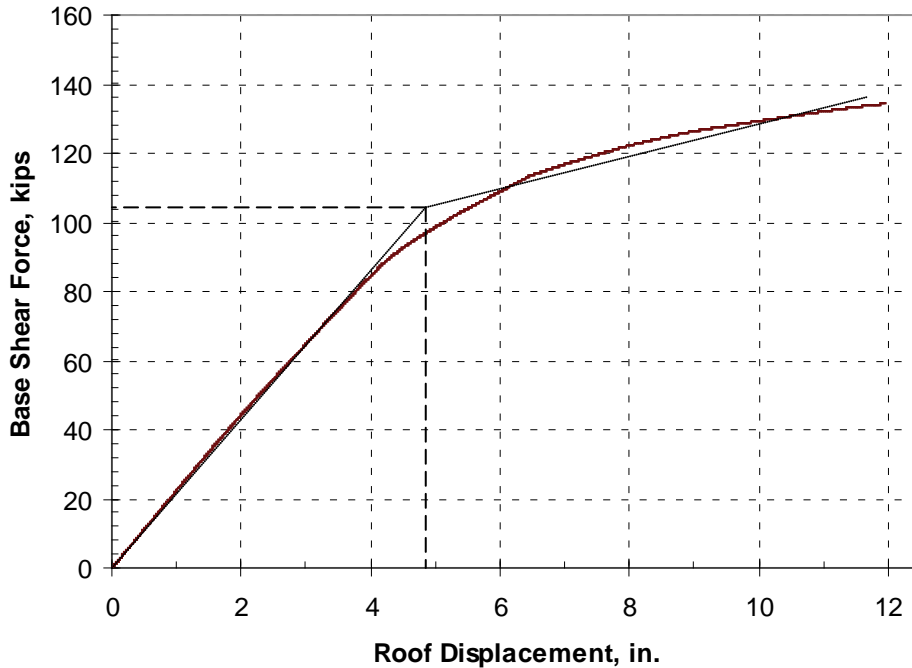

Figure 14 Capacity curve determined in a nonlinear static analysis of the reinforced concrete frame.

CONCLUSION

A simple approach was presented for the design of seismic-force-resisting systems. Estimated yield drifts given in Table 1 and design parameters given in Table 2 were sufficiently accurate that no iteration was required in the example designs. The base shear strength, determined to limit ductility and drift demands, was distributed over the height of the structure according to a new distribution. Required member strengths were determined in conjunction with the development of a desired mechanism using the equations of virtual work. System ductility limits used in the design were derived for currently recognized seismic-force-resisting systems. Roof drift limits are indexed to current allowable story drifts. Thus, the designs obtained with this method are nominally consistent with code performance expectations. Detailing requirements and other limits for such systems as well as other requirements in the 2003 *NEHRP Recommended Provisions* remain applicable.

NOTATION

- a A coefficient that represents the effect of site characteristics on peak displacement response.
- C_1 A modification factor to account for the influence of inelastic behavior on the response of the system, as determined by Equation 17.
- C_2 A modification factor to account for the influence of cyclic degradation of strength and stiffness on the response of the system, as determined by Equation 18.
- C_y Base shear coefficient at yield, equal to V_y/W .
- C_y^* Yield strength coefficient for equivalent single-degree-of-freedom oscillator (dimensionless).
- D_u Roof drift limit, determined as the smaller of $D_{u,\mu}$ and $D_{u,\Delta}$.
- $D_{u,\mu}$ Roof drift limit based on design ductility limit in the direction of interest for the design earthquake.
- $D_{u,\Delta}$ Roof drift limit based on allowable story drift in the direction of interest for the design earthquake.
- D_y, D_y^* Effective yield displacement, at the roof.
- D_y^* Yield displacement of the equivalent SDOF oscillator.
- D_u^* Peak displacement of the equivalent SDOF oscillator.

$F_{i,1}$	Lateral force at Level i of the structure, distributed in proportion to the product of the mode shape amplitude $\phi_{i,1}$ and seismic weight, w_i , at Level i .
$F_{i,\beta}$	Lateral force at Level i of the structure, determined according to Equations 19 and 20.
g	Acceleration of gravity.
h	Average roof height of structure with respect to the base.
h_i, h_j	Height of i^{th} or j^{th} floor above the base.
$h_{eff,1}$	Height of resultant of lateral forces $F_{i,1}$ above the base.
$h_{eff,\beta}$	Height of resultant of lateral forces $F_{i,\beta}$ above the base.
h_{sx}	Story height below Level x .
I	Importance factor in Section 11.5.1 of the 2003 <i>NEHRP Recommended Seismic Provisions</i> .
k_e	Effective stiffness associated with secant stiffness to effective yield point.
k_i	Initial stiffness, typically associated with elastic properties at small displacement amplitudes.
l_w	Length of prismatic wall in plan in direction under consideration.
M_n	Nominal flexural strength.
M_p^+	Plastic moment having positive sense.
M_p^-	Plastic moment having negative sense.
M_{pbr}	Reference plastic moment strength.
M_{pc}	Plastic hinge strength of column.
R^*	Ratio of strength required for elastic response and yield strength of companion inelastic oscillator.
S_a	Design, 5% damped, spectral response acceleration, adjusted for site effects, normalized by g .
S_d	Peak displacement of elastic oscillator, equal to $S_a g (T_e/2\pi)^2$.
T_e	Effective period, associated with secant stiffness to effective yield point, in seconds.
T_i	Initial period, associated with initial stiffness properties, in seconds.
V_i	Story shear at the i^{th} story above the base.
V_y	Effective yield strength, at the base.
V_y^*	Yield strength of the equivalent SDOF oscillator.
w_i	Portion of W that is located at or assigned to Level i .
W	Effective seismic weight of the building, as defined in Section 12.7.2.
W^*	Effective weight of the equivalent SDOF oscillator.
\mathbf{W}	Diagonal matrix containing the entries w_i .
W_E	External work determined in a virtual work analysis.
W_I	Internal work determined in a virtual work analysis.
α	Coefficient in Equation 19, taken equal to 0.75.
α_1	Fundamental mode mass coefficient.
$\alpha_{3,stat}$	Estimate of maximum ratio of interstory drift ratio and average roof drift ratio for the first mode.
β_i	Ratio of story shear just below Level i and base shear at yield, V_y .
Δ_a	Allowable story drift.
$\phi_{i,1}$	Displacement amplitude at Level i of the fundamental mode of vibration of the structure in the direction of interest, normalized to unity at the roof level.
Φ_1	Vector containing the values of $\phi_{i,1}$.
Γ_1	Participation factor of fundamental mode of vibration of the structure in the direction of interest.
μ	System ductility.
μ_c	Effective ductility capacity in the direction of interest for the design earthquake.
μ_d	Design ductility limit in the direction of interest for the design earthquake considering the importance factor, I .
μ_t	Target allowable effective ductility demand in the seismic force resisting system in the direction of interest considering drift and ductility limits, for the design earthquake.
θ_p	Angle used in virtual work analysis, rad.

APPENDIX: YIELD POINT SPECTRA

This appendix provides details on the interpretation, use, and construction of yield point spectra (YPS). YPS (Aschheim and Black, 2000) represent the peak displacement response of an oscillator that has a bilinear load-deformation response. Figure

15 shows such an oscillator and identifies its yield point and peak displacement response schematically. The ductility demand for such an oscillator can be determined for any specific earthquake record using software to compute inelastic response. Alternatively, established ductility ($R-\mu-T$) or displacement coefficient (C_1, C_2) relationships can be applied to smoothed design spectra to estimate the peak displacement for any combination of period and yield strength.

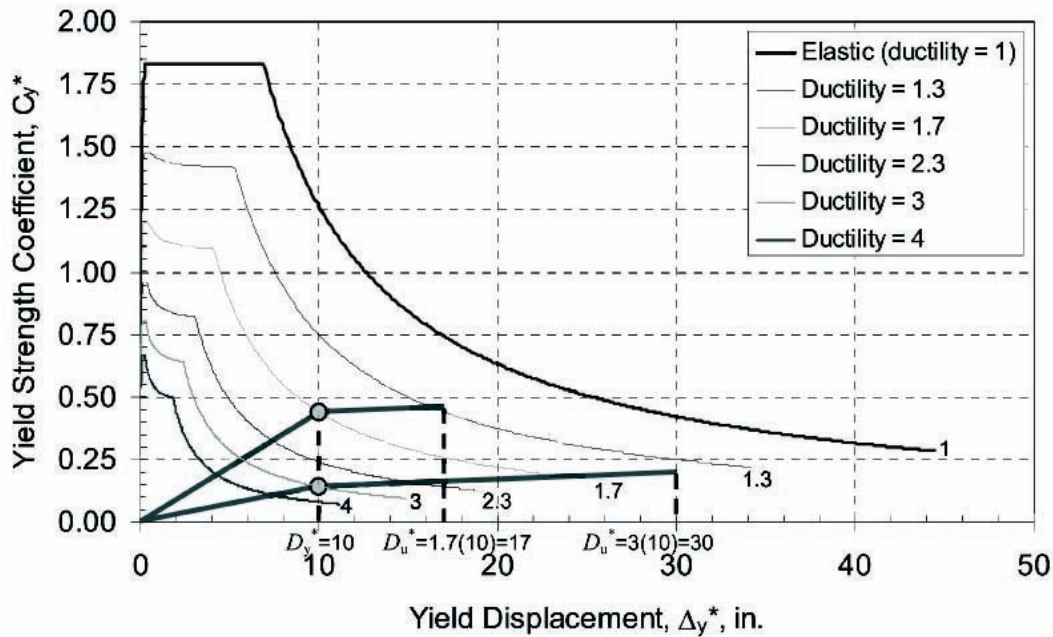

Figure 15 Yield point spectra.

YPS plot displacement ductility demands as a function of the yield point of an SDOF or ESDOF oscillator. In order to be general, the yield strength $V_y^* = C_y^*W$ is normalized by the weight of the oscillator’s mass so that yield strength coefficient, C_y^* , is plotted on the ordinate of the YPS. Thus, YPS can be used to determine the expected ductility demand, which depends on where the oscillator’s yield point (D_y^*, C_y^*) plots on the spectra. The expected ductility demand allows peak displacement response to be assessed on the YPS. For example, Figure 15 illustrates how changes in strength influence the peak displacement response for a given yield displacement. Thus, in the usual design context, the estimated yield displacement is known and the objective is to determine the strength that limits the drift and ductility demands to acceptable levels. Increasing the strength (C_y^*) causes a reduction in both ductility and drift responses. This is easily generalized to consider multiple performance objectives, with each performance objective resulting in a minimum required strength; the largest of the required strengths provides satisfactory performance for all performance objectives.

Just as in the capacity spectrum method, lines of constant period radiate from the origin. Period is related directly (but not linearly) to the slope C_y^*/D_y^* by Equation 15. Thus, a minimum strength for a given yield displacement (resulting from drift and ductility limits) can also be interpreted as a minimum stiffness or maximum period.

YPS differ from the capacity spectrum method in some fundamental ways. Peak displacements are plotted on the abscissa in the capacity spectrum method, while yield displacements are plotted on the abscissa of YPS. The capacity spectrum method relies on equivalent linearization to account for the influence of nonlinearity in the load-deformation response while ductility or displacement coefficient relationships typically are used with YPS. The terms “yield strength coefficient” and “yield displacement” are used in YPS as alternatives to the terms “spectral acceleration” and “spectral displacement” used in the capacity spectrum method because the latter are clearly defined only for elastic response.

Admissible design regions can be constructed by reversing the process for estimating displacement response. The yield points that correspond to a desired peak displacement can be determined and plotted. For example, points corresponding to a peak displacement of 24 in. are shown in Figure 16. These points are determined as described below.

An elastic oscillator having a yield displacement of 24 in. would also have a peak displacement of 24 in.; thus, the required yield strength coefficient, C_y^* , is located on the $\mu = 1$ curve at this yield displacement. Similarly, an oscillator having a yield displacement of $24/1.3 = 18.5$ in. and C_y^* located on the $\mu = 1.3$ curve would have a peak displacement of 24 in. Repeating this process for each ductility curve results in the family of points shown in Figure 16. A line passing through these points represents a boundary of the admissible design region; points below this curve have larger ductility demands and, thus, are

excluded because they would have peak displacements greater than 24 in. For long period systems, results are compatible with the “equal displacement rule” and result in a limit on the period of vibration of the system. For short period systems, this procedure accounts for displacement amplification in establishing the boundary of an admissible design region.

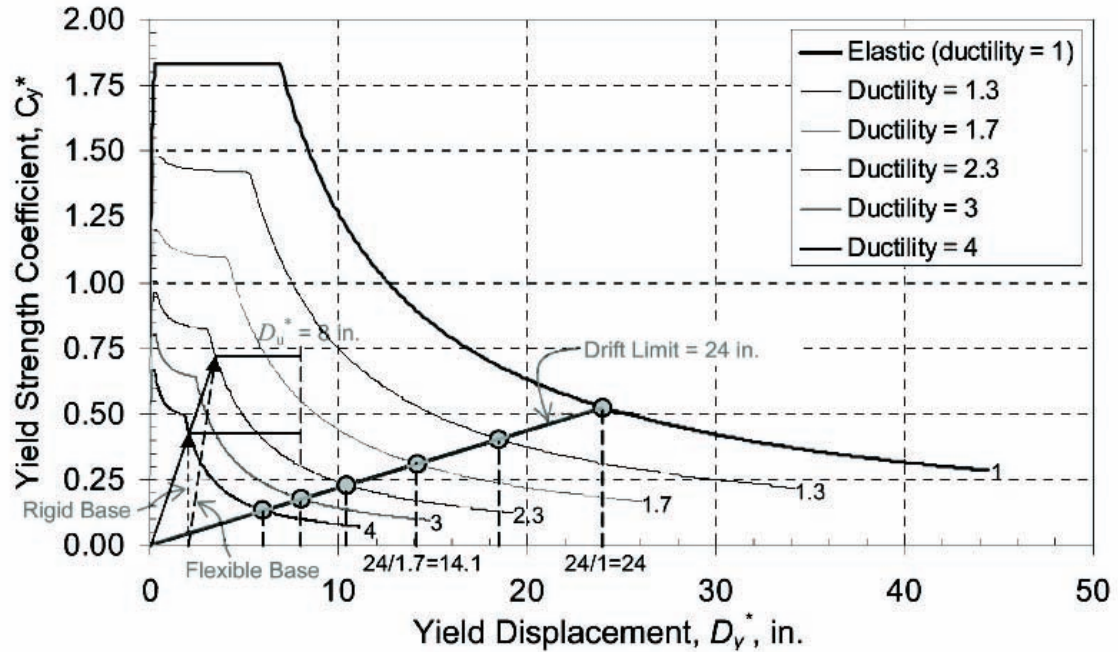

Figure 16 Establishment of the drift limit and illustration of the influence of foundation flexibility on response and required strength.

It is obvious that to ensure ductility demands do not exceed a certain value (e.g., 4) requires excluding yield points below the curve corresponding to this value. The boundaries established by considering drift and ductility limits can be used to establish admissible design regions (ADRs). ADRs can be especially useful in schematic design when comparing alternative seismic-force-resisting systems or for tuning the proportions of a given seismic-force-resisting system in order to modify its yield displacement so that the required lateral strength (or cost) can be minimized while satisfying the performance objective(s).

When appropriate, the influence of elastic foundation flexibility can be addressed using the YPS methodology. Elastic foundation flexibility will cause the yield displacement to increase in proportion to the lateral force. Thus, the system with foundation flexibility can be represented by a line that is inclined (to the right) of the line representing fixed-base conditions (also illustrated in Figure 16). While interstory drift and system ductility limits typically would be unaffected by foundation flexibility, the increase in yield displacement will require that the ductility demand be reduced in order to satisfy a drift limit. As illustrated, this causes the required base shear strength to increase for systems that are controlled by drift. Note that for the shorter period systems controlled by ductility demands, the increase in yield displacement due to foundation flexibility causes a reduction in the required strength.

The construction of YPS is fairly straightforward. Because design spectra and established ductility and displacement coefficient relationships are expressed as functions of period, the usual approach is to determine the strength reduction factor associated with a desired ductility demand for each period of interest. This is usually more straightforward when R - μ - T relationships are used. A simple approach when using displacement coefficients (Equations 16 through 18) in a spreadsheet format is to create functions that return C_1 , C_2 , and the value of R^* for a given period, target ductility, and site coefficient. The function for $R^*(\mu, T_e, a)$ may use an iterative approach to the determination of R^* , initially assuming $R^* = \mu$. In setting up this function it is useful to note that:

$$\mu = \frac{D_u^*}{D_y^*} = \frac{C_1 C_2 S_d}{D_y} = C_1 C_2 R^* \quad (\text{A-1})$$

Then, for any value of μ and T , the yield strength coefficient C_y^* is determined as:

$$C_y^* = \frac{S_a}{R^*} \tag{A-2}$$

and D_y^* is determined as:

$$D_y^* = C_y^* g \left(\frac{T_e}{2\pi} \right)^2 \tag{A-3}$$

The spreadsheet can be organized as shown in Table 6. A smoothed elastic design response spectrum is represented in the first two columns. The spectral displacement, S_d , is given by:

$$S_d = S_a g \left(\frac{T_e}{2\pi} \right)^2 \tag{A-4}$$

because values of S_a have been normalized by the acceleration of gravity.

Table 6 Illustration of Spreadsheet Organization for Determining YPS

Elastic Design Spectrum			Inelastic Spectra					
T_e	S_a/g	S_d (inch)	$\mu = 1.30$			$\mu = 1.30$		
			R^*	C_y^*	D_y^* (inch)	R^*	C_y^*	D_y^* (inch)
0.00001	0.22	0.0000	1.20	0.18	0.0000	1.43	0.15	0.0000
0.01	0.24	0.0002	1.20	0.20	0.0002	1.43	0.17	0.0002
0.02	0.27	0.0011	1.20	0.23	0.0009	1.43	0.19	0.0007
0.03	0.30	0.0026	1.20	0.25	0.0022	1.43	0.21	0.0018
0.04	0.32	0.0051	1.20	0.27	0.0042	1.43	0.23	0.0036

REFERENCES

Aschheim, M. 2000. "The Primacy of the Yield Displacement in Seismic Design," Second US-Japan Workshop on Performance-Based Seismic Design for Concrete Buildings, Sapporo, Japan, September 10-12.

Aschheim, M., and E. Black. 2000. "Yield Point Spectra for Seismic Design and Rehabilitation." *Earthquake Spectra*, 16(2):317-336.

Black, E. F., and M. Aschheim. 2000. *Seismic Design and Evaluation of Multistory Buildings Using Yield Point Spectra*, CD Release 00-04, Mid-America Earthquake Center.

Chao, S.-H., S. C. Goel, and S.-S. Lee. 2007. "A Seismic Design Lateral Force Distribution Based on Inelastic State of Structures," *Earthquake Spectra*, 23(3):547-569, Aug.

Federal Emergency Management Agency. 2005. *Improvement of Nonlinear Static Seismic Analysis Procedures*, FEMA 440. Federal Emergency Management Agency, Washington, D.C.

Goel, S. C., and S.-H. Chao. 2007. "A Performance-based Plastic Design Method (PBPD) for Seismic-Resistant Structures," in review.

Goel, S. C., S. Leelataviwat, S.-S. Lee, and S.-H. Chao. 2007. "Underlying Theory behind Performance-based Plastic Design (PBPD) Method for Earthquake-Resistant Structures," in review.

Paulay, T. 2002. "An Estimation of Displacement Limits for Ductile Systems," *Earthquake Engineering and Structural Dynamics*, (31):583-599.

Prakash, V., G. H. Powell, and S. Campbell. 1993. *Drain-2DX Base Program Description and User Guide, Version 1.10*, Report UCB/SEMM-93/17. Structural Engineering, Mechanics, and Materials, University of California, Berkeley.

Priestley, M. J. N. and M. J. Kowalsky. 1998. "Aspects of Drift and Ductility Capacity of Rectangular Cantilever Structural Walls," *Bulletin of the New Zealand National Society for Earthquake Engineering*, 31(2):73-85.

Priestley, M. J. N. 2000. "Performance Based Seismic Design," 12th World Conference on Earthquake Engineering, Auckland, New Zealand, Jan. 30 – Feb. 4.

Tjhin, T., M. Aschheim, and J. Wallace. 2002. "Displacement-based Seismic Design of Reinforced Concrete Structural Walls," 7th US National Conference on Earthquake Engineering, Earthquake Engineering Research Institute, Boston, July 21-25.

Resource Paper 10

SEISMIC DESIGN METHODOLOGY FOR PRECAST CONCRETE FLOOR DIAPHRAGMS

This resource paper describes a design approach for untopped and topped composite precast concrete diaphragms applicable for all seismic design categories (SDC). The methodology was developed as an integral part of a large industry-endorsed and -supported analytical and experimental research project on precast concrete floor diaphragm. The impetus for the research was the seismic vulnerability of precast concrete floor systems as demonstrated by their performance in recent earthquakes, particularly the 1994 Northridge earthquake (EERI, 1994; Iverson and Hawkins, 1994). While several shortcomings in design practices at that time have been identified (Wood et al., 1995; Fleischman et al., 1996), and positive incremental changes made to code provisions for precast concrete diaphragm design (Wood et al., 2000; Hawkins and Ghosh, 2000), it is clear from the recommendations of Appendix A of Chapter 9 of the 2000 NEHRP Recommended Provisions that a better comprehensive design methodology is needed.

The methodology proposed here specifies:

- a. The performance for which the precast concrete diaphragm should be designed in terms of forces, displacements, and deformations;*
- b. The precast concrete diaphragm connection details that must be used to provide this performance; and*
- c. The required stiffness of the precast concrete diaphragm relative to the stiffness of the lateral-force-resisting system (LFRS).*

The objective of the design methodology is to provide a reliable design that does not compromise the safety, reliability, practicality, or economics of precast concrete construction.

The principal researchers for the study described in this paper were: Dr. Robert Fleischman, University of Arizona; Dr. Clay Naito and Dr. Richard Sause, Lehigh University; and Dr. Jose Restrepo, University of California, San Diego. DSDM Industry Task Group Members guiding the research were: Tom D'Arcy, DSDM Task Group Chair, PCI R&D Committee; founder, The Consulting Engineers Group, San Antonio, Texas; Roger Becker, Vice President, Spancrete Industries, Inc., Waukesha, Wisconsin; Dr. Ned Cleland, President, Blue Ridge Design, Inc., Winchester, Virginia; David Dieter, President/General Manager, Mid State Precast, Inc., Cocoran, California; Dr. S. K. Ghosh, DSDM Project Co-Principal Investigator, President, S.K. Ghosh Associates, Inc., Skokie, Illinois; Harry Gleich, Vice President-Engineering, Metromont Prestress, Greenville, North Carolina; Dr. Neil Hawkins, Professor Emeritus, University of Illinois, Urbana-Champaign, Illinois; Paul Johal, PCI Research Director, Precast/Prestressed Concrete Institute, Chicago, Illinois; Dr. Joseph Maffei, Structural engineer, Rutherford & Chekene Engineers, Oakland, California; Susie Nakaki, President, The Nakaki Bashaw Group, Inc., Irvine, California; Dr. Douglas Sutton, Chair, PCI Research & Development Committee, and Professor, Purdue University, West Lafayette, Indiana. The principal researchers were: Dr. Robert Fleischman, University of Arizona; Dr. Clay Naito and Dr. Richard Sause, Lehigh University; Dr. Jose Restrepo, University of California, San Diego.

PRECAST CONCRETE DIAPHRAGM BEHAVIOR

The following aspects of diaphragm behavior must be addressed in an effective seismic design methodology for precast concrete diaphragms (Fleischman et al, 2005a):

1. Diaphragm force levels assumed to occur during an earthquake are likely to significantly exceed those prescribed by current building code provisions;
2. Complex internal force paths can create force combinations/local deformation demands not anticipated by simple "horizontal beam" representations of a floor diaphragm;
3. Significant diaphragm global deformations can amplify demands on gravity-force-resisting system in regions of the structure distant from the primary (vertical-plane) LFRS elements.

These concerns are not unique to precast concrete diaphragms. They are equally applicable to the diaphragms of many large box-type and tilt-up structures. However, the jointed nature of precast concrete diaphragms creates a condition in which these factors can lead to poor structural performance if they are not directly considered in the design. (See Section A2 for a more detailed description of these concerns.)

Because of cracking along the joints between precast units, toppings do not ensure monolithic diaphragm action (Wood et al.,

2000). For untopped or topped precast concrete diaphragms, the critical diaphragm cross-sections occur at the joints between the precast floor units. Thus, the combination of diaphragm forces greater than those specified by codes and internal force combinations not currently recognized by simple beam idealizations of diaphragms can lead to yielding of the discrete reinforcement or connectors crossing the joints. In the event of this yielding, inelastic deformation will concentrate locally at the joints, and the diaphragm stiffness is significantly reduced by cracking and deformation of the elements crossing the joints.

DESIGN RAMIFICATIONS

Precast concrete diaphragm design has traditionally assumed elastic behavior and focused on providing sufficient strength. It has not considered that there may be a need for inelastic deformation capability. The potential for localized concentrations of inelastic deformation demand implies that a prescriptive elastic design for the diaphragm (i.e., one without any ductility requirements for the diaphragm reinforcement) would need to ensure elastic behavior.

The diaphragm forces expected during strong ground shaking can be much larger than current code specified diaphragm design force levels (Lee and Kuchma, 2007; Rodriguez et al., 2001). In some cases, the large diaphragm forces are driven by changes in the structure's dynamic properties after yielding of the primary elements of the LFRS (Fleischman et al., 2002; Eberhard and Sozen, 1993). As a result, even a capacity design approach in which the diaphragm is designed considerably stronger than the primary LFRS (wall or frame) elements and first yielding is successfully produced in those LFRS elements while the diaphragms are still elastic, is no guarantee of sustained elastic diaphragm behavior throughout the seismic event. A prescriptive elastic diaphragm design, therefore, may be difficult to achieve economically for all situations.

Given the complex internal force paths inherent in floor systems, including the effect of openings for stairwells, elevators and parking garage ramps, and the potential for alternate load paths in secondary elements within the floor system, it is unclear whether designs based on simple horizontal beam representations can avoid localized inelastic deformation demands for all situations, even if proper account is taken of the actual diaphragm forces likely in large ground shaking events. A prescriptive elastic diaphragm design, therefore, may be difficult to achieve reliably for all situations.

Deformation capacity needs to be built into the precast floor system (Lee et al., 2007). Accordingly, the approach adopted for the design methodology is to target elastic diaphragm response but anticipate the need for inelastic deformation capacity. In this way, impractical (connectors spaced too closely) or uneconomical (cost of significantly more connectors) designs can be avoided; yet, the penalty for unanticipated load paths or localized concentrated inelastic deformation is no longer a nonductile failure (loss of load carrying capacity) of the floor system but is instead repairable damage to the floor system.

The use of performance targets allows parallel design requirements related to diaphragm flexibility to be considered at the same time as diaphragm strength and deformation capacity. The primary requirement in this regard pertains to limiting the flexible-diaphragm amplified drifts of gravity system columns and walls (out-of-plane displacement of walls) in regions of the structure distant from primary LFRS elements.

PROPOSED DESIGN APPROACH

The design approach for the proposed seismic design methodology is based on performance targets for the diaphragm seismic response. The selected performance targets are enforced through a combination of design factors and detailing requirements. The design methodology provides the designer with the flexibility of selecting from a number of options.

The basic design option (BDO) targets elastic diaphragm behavior for the design basis earthquake (DBE). As such, a certain amount of inelastic diaphragm deformation is anticipated in a maximum considered earthquake (MCE). This target is selected based on the research findings discussed above, showing that attempting to enforce elastic behavior in precast diaphragms for all seismic response situations can be impractical. Instead, the BDO involves the use of more realistic diaphragm design forces, higher for most cases than those currently used in practice, in combination with detailing provisions that build a measure of inelastic deformation capacity into the diaphragm.

In some cases, the basic design objective is neither practical nor necessary. In such cases, two alternatives are offered: an elastic design option (EDO) that may provide the best design option for less demanding cases (e.g., squat diaphragm geometry or a low SDC) and a "relaxed" design option (RDO) in which a limited amount of inelastic diaphragm deformation is accepted in the DBE in order to lower diaphragm design forces. The second option may be necessary for practical designs in demanding cases (e.g., long span untopped diaphragms for use in high SDCs).

Figure 1 shows a schematic of diaphragm response in terms of monotonic pushover curves (diaphragm force vs. diaphragm midspan deformation). The lower curve is the expected performance of current diaphragm designs for high SDCs -- the

diaphragm force in a significant seismic event is expected to exceed current design forces and, in the absence of any detailing requirements, the diaphragm will likely undergo a nonductile failure (shown by the lowest X). The upper curve is the performance intended by the proposed BDO design approach. Shown on this upper curve are key points related to the design approach.

The design approach employs the following features to achieve its objectives:

1. An amplified diaphragm design force,
2. A higher relative strength for the diaphragm shear reinforcement and the connections to the LFRS than the diaphragm chord reinforcement,
3. A classification system for diaphragm reinforcement, and
4. Limits on the diaphragm contribution to interstory drift.

As indicated in Figure 1, the following terminology and notation track these measures during the calibration stage: a diaphragm design force amplification factor, Ψ_D ; a diaphragm shear overstrength factor, Ω_v , and an anchorage overstrength factor, Ω_a ; diaphragm reinforcement and connection classification categories LDE (low deformability elements), MDE (moderate deformability elements) and HDE (high deformability elements); and a diaphragm drift limit, δ_x .

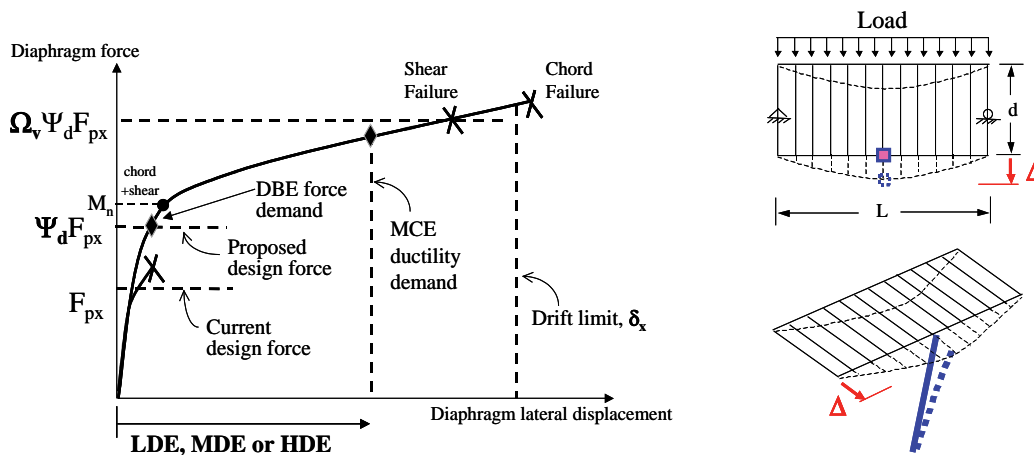

Figure 1 Diaphragm response curve (left) and diaphragm force and deformation (right).

The Ψ_D factor is applied to the current code specified diaphragm design force to increase the diaphragm strength to the DBE force target. This approach requires some deformation capacity in the diaphragm reinforcement for the MCE event, which may be MDE or HDE depending on the parameters of the design. The Ω_v factor is applied to the diaphragm shear reinforcement to prevent a non-ductile shear failure from occurring while the diaphragm deforms in the MCE demand. This displacement demand needs to be within allowable drift limits (right side of Figure 1).

Figure 2 shows pushover curve schematics for two situations in which the elastic design option (EDO) may be desirable. The left side of Figure 2 shows the low seismic hazard case. The BDO also can be used for this case as shown by the lighter (gray) curve. However, the forces $\Psi_e F_{px}$ required for the EDO (dark black curve) may not be significant in terms of absolute values and, thus, it may be more desirable to relax the stricter requirements of an HDE design.

The right side of Figure 2 shows the squat geometry case. Again, the BDO can be used for this case. The MCE ductility demand is not large (due to diaphragm geometry) and so MDE reinforcement can be used. However, since the mass and length of the squat diaphragm are less than for a longer diaphragm, the internal shear and moment are lower for a given acceleration. Thus, designing the diaphragm strength $\Psi_e F_{px}$ to the upper diamond in Figure 2 (right) (i.e., an EDO) also is feasible. The EDO is a reasonable option for a squat diaphragm geometry or a low SDC diaphragm.

Figure 3 shows the relaxed design option (RDO). This option is desirable when the diaphragm force is sufficiently large to make the spacing of diaphragm connections impractical as is the case for pretopped long span diaphragms for high SDCs. By relaxing the elastic diaphragm requirement for the DBE target, all the design forces for the diaphragm are reduced including the “stacked” factors $\Psi_D \Omega_v$ applied to the shear reinforcement. Naturally, a larger inelastic deformation capacity is required for the MCE and, thus, HDE reinforcement will be required. The different features of the design approach are described below.

Diaphragm Design Force. The diaphragm global performance targets are achieved through specifying appropriate diaphragm design force levels. The proposed design approach will accomplish this objective through the use of amplified diaphragm design forces. The required magnitude of the diaphragm design force amplification Ψ_D is based on the design intent (BDO, EDO, RDO) as well as a number of structural parameters including: diaphragm span, LFRS type, building configuration, and number of stories.

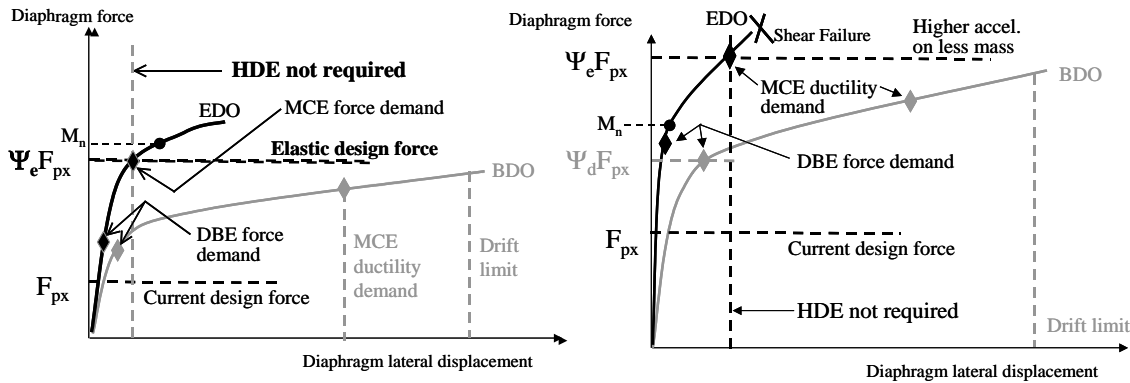

Figure 2 Elastic design option (EDO): low seismic hazard (left) and squat diaphragm geometry (right).

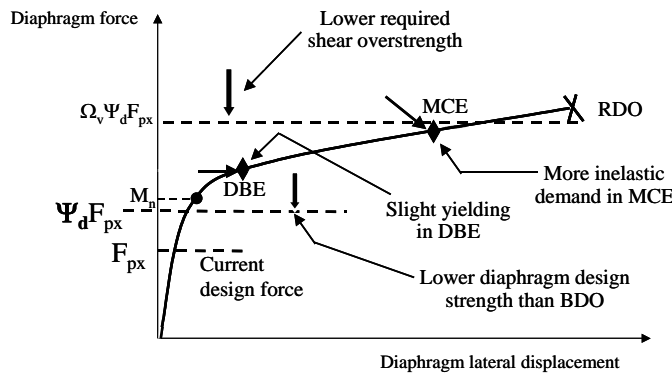

Figure 3 Relaxed design option (RDO).

The manner in which diaphragm force amplification will be introduced into the design methodology is currently under consideration (see Section A2). During the research phase, a generic term, the diaphragm design force amplification factor, Ψ_D , has been used for calibration purposes. The Ψ_D factor is expressed relative to the code prescribed diaphragm design force values in place at the onset of the research project in 2003. A constant diaphragm force pattern, regardless of the floor level in the building, is envisioned for the design methodology. This contrasts with the increasing force values for increasing floor levels in current codes. The Ψ_D factor is calibrated with respect to the maximum diaphragm force relative to current code force values, (typically the force for the uppermost level diaphragm). The research studies completed to date indicate that appropriate Ψ_D values are 1.4 to 2.0 (BDO), 1.0 to 1.5 (RDO) and 1.75 to 2.5 (EDO).

Diaphragm Reinforcement Relative Strength. The design approach uses capacity design concepts to produce a hierarchy of design strengths among the reinforcement groups in the diaphragm. This approach recognizes the need to form a ductile deformation mechanism in an overload situation. The primary diaphragm reinforcement groups are chord reinforcement, shear reinforcement, and collector/anchorage reinforcement. A hierarchy of design strengths is used that is intended to protect the shear and anchorage reinforcement against failure and ensure ductile flexural limit states.

The relative strength increases for the diaphragm shear and anchorage reinforcement are a function of the design intent (BDO, EDO, RDO) as well as structural parameters including diaphragm span, Seismic Design Category, and diaphragm detail classification.

The manner in which the hierarchy of diaphragm reinforcement relative strengths is introduced into the design methodology is still evolving (see Section A3). During the research phase, generic terms, the diaphragm shear overstrength factor, Ω_v , and the anchorage overstrength factor, Ω_a , have been used for calibration purposes. The overstrength factors for the shear reinforcement and anchorages are applied to internal force values based on the already amplified diaphragm design force value (i.e., they are additional to the Ψ_D factor). Initial studies indicate that ranges for Ω_v and Ω_a are likely to be 1.1 to 1.4 and 2.0 to 2.5, respectively.

Diaphragm Detailing. A classification system ensures that the diaphragm details specified have the necessary characteristics to produce the desired performance. A classification system is necessary given the many different types of reinforcing details for precast concrete diaphragms, including proprietary and non-proprietary details.

The diaphragm detail classification system is based on deformation capacity with the following categories: low deformability elements (LDE), moderate deformability elements (MDE), and high deformability elements (HDE). The use of different categories recognizes that expected seismic demands, as controlled by the design factors, will not always require the strictest level of detailing.

The option selected for the diaphragm design will dictate the diaphragm detail categories or vice versa. In general, the EDO needs only LDE elements while the RDO requires HDE elements. The BDO can use MDE or HDE elements depending on the parameters of the design.

The detailing requirements for MDE and HDE elements ensures that a hierarchy of strengths exists among the elements (bars, plates, welds, anchors, etc.) within the reinforcing details so as to promote ductile behavior with the HDE being required to demonstrate a certain level of deformation capacity.

An examination of current detailing practice for representative details (Naito et al., 2005) indicates that such hierarchies are not present in many current details. However, certain existing diaphragm connectors that are LDE can be enhanced to MDE through improved detailing.

The category assigned to a given detail is based on a qualification procedure that includes specifications for detailing requirements and protocols to demonstrate the detail's characteristics through physical testing (see Section A4). The procedure can be used to prequalify existing details or serve as a mechanism for qualifying new detailing concepts.

Diaphragm Stiffness and Strength. The design approach uses an elastic stiffness calculation to ensure that the diaphragm flexibility is within acceptable limits with respect to interstory drift of gravity system columns and walls in regions of the structure distant from the primary LFRS elements and to adjust the diaphragm amplification and overstrength factors for the effect of diaphragm flexibility on the structure's modal properties.

The design approach requires a flexural strength calculation to select the flexural reinforcement. In accordance with research findings and consistent with recent code modifications (ACI, 2008), the flexural strength includes the tension contribution of the diaphragm shear reinforcement to diaphragm flexural strength.

A spreadsheet method has been developed to determine the effective moduli (G_{eff} , E_{eff}) for the calculations of stiffness and diaphragm flexural strength (M_n). The method is based on estimating the neutral axis depth (different formulations are used for strength and stiffness) and spreading the lower joint stiffness over the precast panel (see Section A5). The method has been initially calibrated with respect to analytical results and is currently being calibrated to experimental results.

Diaphragm Load Path. The design approach implicitly accounts for force combinations on individual reinforcing elements within the diaphragm and/or entire diaphragm joints since the design factors are calibrated from analytical models that capture these combined actions. Further, the effects of concentrated inelastic deformations on the local deformation demands for the diaphragm reinforcement are likewise included in the models used for calibration.

However, a design approach that builds a measure of deformation capacity into the diaphragm must ensure that the deformation demands are occurring in the intended regions and not in an alternate unanticipated load path. This is particularly important for precast concrete diaphragms because the precast floor system is an assemblage of several types of precast elements including so-called "secondary" elements (spandrels, inverted tee beams, lite walls) that are not formally included in the diaphragm design but nevertheless may participate in the diaphragm action. The connections for these secondary elements are often industry standard hardware rather than elements designed for a seismic force. These elements do not usually possess sufficient strength or deformation capacity for plastic redistribution. Thus, if a section along the force path cannot accommodate the forces or displacements, a nonductile failure may occur.

Finally, if the diaphragm is irregular, an explicit accounting for the load path may be required. The simple "horizontal" beam procedure currently used in practice can be used if the diaphragm configuration meets certain limiting requirements. If not, the designer will have two choices: apply internal force amplification factors based on the diaphragm configuration or

perform a static FE analysis of the floor system under inertial force to calculate the factors directly. A similar procedure is to be used for the collectors and anchorages. Issues pertaining to the load path are discussed in Section A6.

LIST OF ACRONYMS

AR = aspect ratio
BDO = basic design option
DBE = design basis earthquake
DOF = degree of freedom
DSDM = diaphragm seismic design methodology
EDO = elastic design option
ELF = equivalent lateral force
FE = finite element
HDE = high deformability element
LDE = low deformability element
LFRS = lateral-force-resisting system
MCE = maximum considered earthquake
MDE = moderate deformability element
NLDTA = nonlinear dynamic transient analysis
RDO = relaxed design option
RDOF = reduced degree of freedom
SDC = Seismic Design Category
SP = spandrel

APPENDIX

A1 Key Aspects of Precast Concrete Diaphragm Behavior

A1.1 Diaphragm Force Levels. Research has shown that the maximum diaphragm force event occurring at a given floor during a design basis earthquake (DBE) may be substantially larger than current design force levels (F_{px}) and even larger (two or more times larger) in the maximum considered earthquake (MCE) (DSDM, 2006). Furthermore, the maximum inertial forces may occur in the lower floors of the structure in direct contradiction to current ELF code specified patterns. Such observations have also been deduced from accelerations measured during earthquakes (Hall, 1995) and in shake table tests (Kao, 1998). The relative magnitude of the expected maximum diaphragm force to the current design force has been shown to be dependent on several factors pertaining to building dimensions and configurations, the LFRS type, strength and layout, and the ground motion intensity.

Necessary Feature of Design Methodology. Specification of appropriate diaphragm design force levels and associated diaphragm design force patterns.

Design Methodology Approach. Appropriate diaphragm force levels are assigned through the use of a diaphragm force amplification factor Ψ_D (see Section A2).

A1.2 Diaphragm Internal Force Paths. Current U.S. practice uses a horizontal beam model to determine the internal forces (moment and shear) due to F_{px} . Chord reinforcement is provided to carry the in-plane bending moment; shear reinforcement across panel joints parallel to the seismic force is designed to carry the in-plane shear; and collectors bring these forces to the LFRS. The following observations are made with respect to the current design model:

1. Regions of the diaphragm may be subject to complex force combinations (shear, moment, and thrust coinciding at a section) that are more demanding than the internal forces determined from the simple horizontal beam model. The additional forces can be due to restraint resulting from, or differential movements of, the vertical elements of the LFRS, the direction of application of the seismic excitation, and openings or other irregularities in the floor system.
2. Shear strength design equations based on inclined cracking are not consistent with the observed behavior for topped precast concrete diaphragms (Wood et al., 2000). Further, the 90-degree paths associated with collectors do not provide a fully rational load path to the primary (vertical plane) LFRS elements.
3. In precast concrete diaphragms alternate load paths may occur in the floor system through secondary elements such as spandrels or inverted tee beams. These paths are unanticipated by the horizontal beam model.

4. In ACI 318-08, the assumption that the chord reinforcement alone resisted the assumed design moments is replaced by an approach permitting all the longitudinal reinforcement in the diaphragm to be assumed to contribute to its flexural strength.

The horizontal beam assumption relies implicitly on plastic redistribution because it is assumed that the diaphragm forces are resisted by their intended reinforcement group. However, no formal requirements currently exist for that reinforcement to have the needed deformation capacity. Sufficient deformation capacity must be provided for precast diaphragm reinforcement details so that they can develop and maintain the desired joint strength. This requirement is considered in Section A1.3.

Necessary Features of Design Methodology. An accurate yet simple method is needed for determining diaphragm internal forces including the likely force combinations on individual reinforcement or reinforcement groups and anticipating alternate load paths. Using this method requires that:

1. Precast diaphragm reinforcement details should be designed for force combinations when appropriate.
2. More rational load paths should be used to distribute forces to the primary LFRS elements.
3. The alternate load paths in secondary elements should be accounted for or mitigated, including preclusion of non-ductile failure modes in secondary elements.

Design Methodology Approach. The current “horizontal” beam procedure can be used if the diaphragm configuration meets certain limiting requirements. If not, the designer will have two choices: (1) apply internal force amplification factors based on diaphragm configuration or (2) perform a static FE analysis of the floor system under inertial force to calculate the factors directly. A similar procedure is to be used for collectors and their anchorage to the LFRS.

A1.3 Diaphragm Detailing. Existing precast concrete diaphragm connector details have been developed without full consideration of expected local deformation demands due to joint opening. As described in the previous section, a certain amount of deformation capacity is needed simply to develop the anticipated joint strength. As an example, consider shear reinforcement in high flexure regions. This reinforcement is actually under high tension due to in-plane bending of the diaphragm. The tension deformation demand on the shear reinforcement due to joint opening will be similar to that of the nearby chord reinforcement. Likewise, chord reinforcement in high shear regions must undergo a similar shear deformation demand due to joint sliding as the shear reinforcement. Thus, for an elastic design based on the horizontal beam model, a certain level of reliable deformation capacity is required. However, the design philosophy adopted here will in some cases require the diaphragm to possess a measure of inelastic deformation capacity to provide structural integrity for the diaphragm during strong ground shaking. The intent of this approach is to assume inelastic deformation in certain diaphragm reinforcing elements while protecting other elements through capacity design concepts.

Necessary Features of Design Methodology. Necessary to the design methodology are:

1. Specification of appropriate capacity design factors to protect certain diaphragm reinforcing elements;
2. Specification of the expected inelastic deformation demands for other diaphragm details for a given set of design parameters; and
3. Demonstration of reliable deformation capacity for the diaphragm details in question.

Design Methodology Approach. The relative strength of different diaphragm reinforcement groups is specified by diaphragm overstrength factors applied to the shear reinforcement (Ω_v) and the collectors and their anchorages (Ω_a). The appropriate factor is selected based on a number of design parameters. A classification system (LDE, MDE or HDE) is used to ensure that appropriate precast diaphragm primary reinforcement details are used in conjunction with these design factors to meet the design intent. Precast diaphragm reinforcing elements can be prequalified for a classification or can undergo qualification testing following an established protocol. Appropriate secondary details are required to mitigate unanticipated load paths through secondary elements.

A1.4 Diaphragm Flexibility. Precast concrete construction is commonly and effectively used for building systems with long floor spans. In these structures, distances between the primary LFRS elements can produce a diaphragm that is relatively flexible. The diaphragm flexibility is further increased by the inherent flexibility of a jointed system in comparison to a monolithic system. For these flexible diaphragms, the floor system and connected gravity force-resisting columns in regions removed from the primary LFRS elements can undergo amplified drift demands (Ju and Lin, 1999; Tena-Colunga and Abrams, 1992). These drift demands can be significant for long span precast concrete structures in a MCE (Lee and Kuchma, 2007; Fleischman et al., 2002).

Necessary Feature of Design Methodology. Specification of a diaphragm elastic stiffness calculation procedure that can be used to properly estimate seismic design forces and check drift limits.

Design Methodology Approach. The interstory drift, typically calculated as the difference in LFRS drift for adjacent floor levels, must include a diaphragm deformation component.

A2 Determining Appropriate Diaphragm Force Amplification Factors

A2.1 Previously Proposed Approaches. Table A2-1 shows some of the diaphragm force amplification factors proposed in the past:

1. Nakaki (2000) identified important inconsistencies in the then current code including designing the diaphragm to the primary LFRS “first yield”. She proposed using a system overstrength factor Ω_o to amplify the diaphragm design force.
2. Rodriguez, Restrepo and Carr (2001), pointed to the importance of higher mode contributions to diaphragm force and proposed calculating a diaphragm force $F_{dia} = \lambda \Omega_i (PGA) W_{dia}$ where λ is the importance factor, PGA is the peak ground acceleration and Ω_i is a magnification factor based on the vertical location of the floor and the influence of higher modes and for which only the first mode acceleration was reduced by the R factor:
3. Fleischman et al, 1998, investigated precast parking structures and proposed that a constant diaphragm design force pattern be used. Fleischman and Farrow (2003), investigated frame and wall structures with flexible diaphragms, and proposed calculating the diaphragm force using a diaphragm overstrength factor Ω^* where: Ω^* targets the elastic diaphragm response in the DBE and Ω_e^* targets the response for the MCE; there is a diaphragm flexibility factor β that ranges from 0 (rigid) to 0.4 (highly flexible); Ω^* is a function of β and the number of stories for wall structures (see Table A2-2); and Ω^* is 1.0 for frame structures.
4. The 2000 and 2003 *NEHRP Recommended Provisions* Appendix A to Chapter 9 for Untopped Precast Diaphragms proposed a factor that combined the system overstrength factor with the redundancy factor.

Table A2-1 Comparison of Diaphragm Force Amplification Factors

Researcher	Nakaki	Rodriguez/ Restrepo/Carr	Farrow/Fleischman/ Sause	NEHRP Appdx. To Chap. 9
Design Force Approach	Design to LFRS Ultimate	Use R Factor on 1 st mode only	Ω is function of diaphragm flexibility	Higher factor for untopped
Design Force	$\Omega_o = 2.8^a$	Ω_i	$\Omega = 1.0-3.0$	$\rho\Omega_o$

^a For squat shear walls, use $R = 1$.

Table A2-2 Overstrength Values for Differing Story Numbers and Diaphragm Flexibility

β Stories	Ω					Ω_e				
	0.2	0.25	0.3	0.35	0.4	0.2	0.25	0.3	0.35	0.4
1	1.0	1.1	1.2	1.4	1.55	1.9	1.85	1.8	1.7	1.6
2	1.2	1.3	1.45	1.7	1.85	2.3	2.25	2.15	2.05	1.95
3	1.4	1.5	1.7	1.95	2.2	2.7	2.6	2.5	2.4	2.3
4	1.6	1.7	1.95	2.2	2.5	3.1	3.0	2.9	2.75	2.6
5	1.8	1.95	2.2	2.5	2.7	3.45	3.35	3.25	3.15	2.9
6	2.0	2.15	2.45	2.8	3.0	3.8	3.65	3.5	3.35	3.2

A2.2 DSDM Project Research Approach. The ratio of the magnitude of the expected maximum diaphragm force to the current code specified force depends on several factors related to building dimensions and configurations, LFRS type and layout, and ground motion intensity (DSDM, 2006). The DSDM project is calibrating the appropriate ratio (Fleischman et al., 2005b) using two research activities:

1. A comprehensive statistical analytical parameter study using nonlinear dynamic transient analysis (NLDTA) of reduced degree-of-freedom (RDOF) models being performed at UCSD.
2. A smaller number of NLDTAs using large degree of freedom three-dimensional finite element (3D-FE) models of prototype structures being performed at the University of Arizona.

The analytical models were built using characteristics obtained from experiments on individual diaphragm reinforcing details performed as part of the overall project (Naito et al. 2005). The analytical models are being verified through comparisons with the results of hybrid testing of joint sub-assemblages at Lehigh University and a half-scale shake table test at UCSD (Fleischman et al, 2005b).

RDOF Study. The left side of Figure A2-1 shows a representation of the RDOF model. The diaphragm is modeled as a beam with its shear and flexural stiffness determined using the method described in Section A5. The parameters varied in this study include: diaphragm span, LFRS type, building configuration, number of stories, Seismic Design Category (SDC), design target, and detailing. Structures are designed for four sites as shown in Table A2-3 and are subjected to suites of 10 ground motions for each site.

Table A2-3 Representative Seismic Sites

Location	Soil	S_s	F_a	S_{MS}	S_{DS}	S_1	F_v	S_{M1}	S_{D1}	SDC
Knoxville	C	0.58	1.17	0.68	0.45	0.147	1.65	0.24	0.16	C
Seattle	C	1.58	1.00	1.58	1.05	0.55	1.30	0.71	0.47	D
Berkeley	C	2.08	1.00	2.08	1.39	0.92	1.30	1.21	0.81	E
Charleston	F	1.39	0.94	1.30	0.87	0.40	2.75	1.10	0.73	E

The right side of Figure A2-1 shows sample results from a suite of 10 earthquake motions for a single set of design parameters (Berkeley DBE, three-story, perimeter shear wall layout, aspect ratio of 2). Median floor acceleration is plotted along the length of the floor for each story. The current code design value is shown as a straight broken line. For this design case, a Ψ_D factor of approximately 1.4 is required to target elastic response for the median response in the DBE for all the diaphragms in the structure.

3D-FE Analysis. On the left, Figure A2-3 shows an example of a 3D-FE model for a three-bay two-story parking structure. Spring elements with cyclic characteristics represent the shear and chord reinforcement, described further in Appendix 3, and the plastic hinging in the walls. The effect of secondary elements such as spandrels and their connections are included.

On the right, Figure A2-3 shows sample results of chord reinforcement axial, (opening), deformation demand for designs using different Ψ_D (OD) factors. A $\Psi_D = 1.0$ leads to a maximum (inelastic) chord deformation demand of 0.9 inch in the DBE. This value drops to 0.35 inch for $\Psi_D = 1.5$, and the response is fully elastic for $\Psi_D = 2.0$. The MCE demands for the latter two cases are 0.5 and 0.12 inch, respectively.

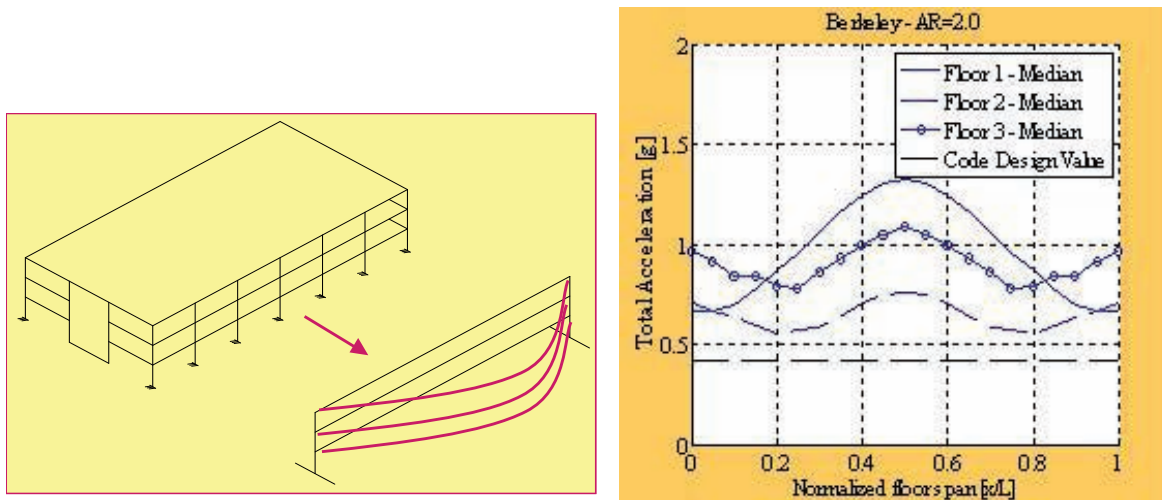

Figure A2-1 Schematic of RDOF model (left) and sample results for the floor (right).

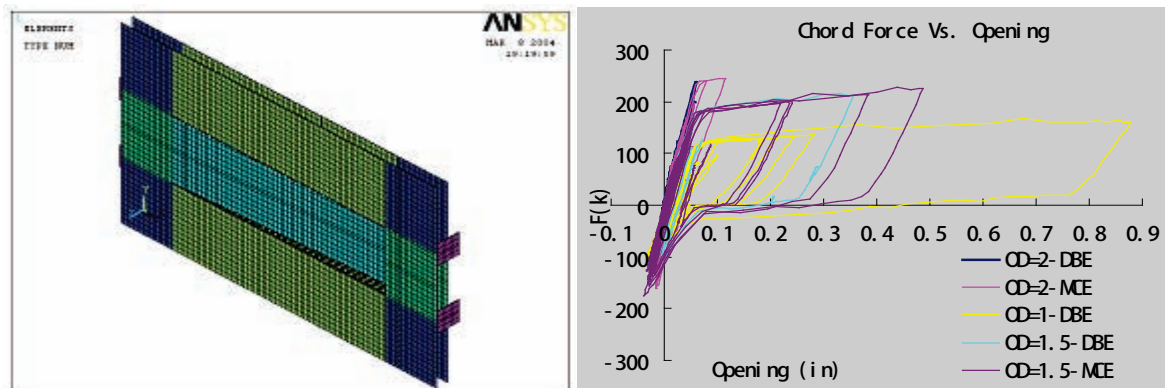

Figure A2-3 Schematic of 3D-FE model (left) and sample results for chord force vs. opening (right).

Such results allow calibration of Ψ_D with respect to diaphragm detail classification (LDE, MDE and HDE). Testing has shown that HDE chord details can reliably achieve cyclic tension deformation amplitudes of 0.6 inch and that MDE details reliably achieve 0.25 inch deformation (see Section A4). For this design, the use of $\Psi_D = 1.5$ and HDE details is a viable RDO solution. For a BDO solution, $\Psi_D = 2.0$ would be required although MDE reinforcement could be used.

Possible Expression for Diaphragm Force Amplification. The proposed form for the amplification factor is:

$$F_{px} = \frac{\omega_{dia} \Psi_{vert}}{\mu_{dia}} F_x$$

where F_x = the story force; ω_{dia} = the dynamic amplification of diaphragm (depends on story); ψ_{vert} = the overstrength of vertical LFRS; and μ_{dia} = the ductility capacity of the diaphragm as a whole – depends on connections used (for elastic diaphragm design (e.g., short spans, low SDC), $\mu_{dia} = 1.0$).

A3 Determining Appropriate Diaphragm Reinforcement Relative Strength. The methodology uses a capacity design approach to protect specific diaphragm reinforcement groups (Standards New Zealand, 1997). The required relative strength of the panel to panel shear reinforcement, and the diaphragm to LFRS anchorage reinforcement, to the chord reinforcement has been found to depend on several factors including diaphragm dimensions and configurations, and diaphragm detailing (Fleischman and Wan, 2007). The DSDM project is calibrating the shear and anchorage relative strength factors using two research activities:

1. A comprehensive parameter study of precast floor diaphragms using nonlinear static “pushover” analyses of simplified representations of individual diaphragms (Fleischman and Wan, 2007).
2. A smaller number of 3D-FE nonlinear dynamic transient analyses (NLDTA) of prototype structures to calibrate or verify the findings from the first research activity.

2D-FE Study. The graphic on the left side of Figure A3-1 shows a schematic of the 2D diaphragm model used for nonlinear pushover analyses. The parameters that were varied for this model were diaphragm span and aspect ratio (AR), Seismic Design Category (SDC), and diaphragm detailing classification.

On the right, Figure A3-1 shows the diaphragm pushover curves for a single set of diaphragm design parameters ($AR = 3$, $L = 180'$, Charleston) with increasing diaphragm shear reinforcement relative strength Ω_v . The greater the Ω_v value, the greater the deformation capacity achieved by the diaphragm. A Ω_v of 2.15 is needed to develop the full diaphragm flexural strength. However, using less shear reinforcement (Ω_v of 1.76 and 1.37), while not preventing shear failure, delays the failure sufficiently to allow some increased inelastic deformation in the diaphragm. Note that, as indicated in the inserts in Figure A3-1, a chord failure occurs at midspan while a shear failure occurs at the first panel-to-panel joint (assuming that $\Omega_a > \Omega_v$). The performance is also characterized by the overall ductility of the diaphragm, μ .

Design charts have been constructed using the results of the studies. On the left, Figure A3-2 shows, for a given diaphragm geometry, the Ω_v values required to achieve specific design targets (diaphragm yield strength, M_y ; diaphragm ultimate strength, M_u ; diaphragm ductility ratio, μ ; and interstory drift, ϕ). Likewise, by examining the internal state of the diaphragm, the right side of Figure A3-2, the required deformation capacity of the diaphragm chord reinforcement, $\delta_{i,max}$, needed to achieve a given design target was determined.

The appropriate design target for a given design is being determined from the second research step: NLDTAs of 3D-FE models of the prototype structures.

3D-FE Analysis. The 3D FE analyses determine the expected local demands on diaphragm reinforcement crossing diaphragm joints by realistically modeling the connector behavior in finite element models of prototype precast structures. These structures are designed for differing SDCs per current code with requirements adjusted using the diaphragm design factors described in this document. The structures are subject to a suite of 10 ground motions scaled to the expected seismic hazard (DBE and MCE) for the design in question.

The finite element models employ discrete coupled springs that represent the shear-tension response of the diaphragm reinforcement crossing the joint. Contact elements are placed in parallel to model the compression zone and friction contributions. The characteristics for the spring elements are obtained from experiments on panels with differing individual diaphragm reinforcement details.

On the left, Figure A3-3 shows a photograph of one of the Lehigh Phase 1 tests used to determine FE connector model characteristics (Naito et al., 2005). On the right, Figure A3-3 shows a sample test result for a shear connector under cyclic loads and the response of the calibrated spring element adjusted to match the test result.

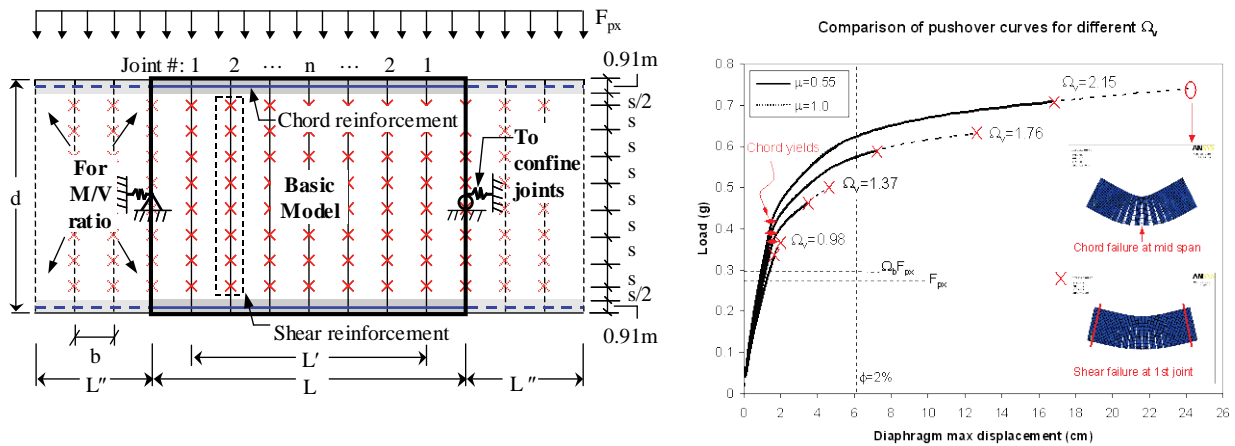

Figure A3-1 Schematic of 2D FE model (left) and sample results for diaphragm shear overstrength factor Ω_v .

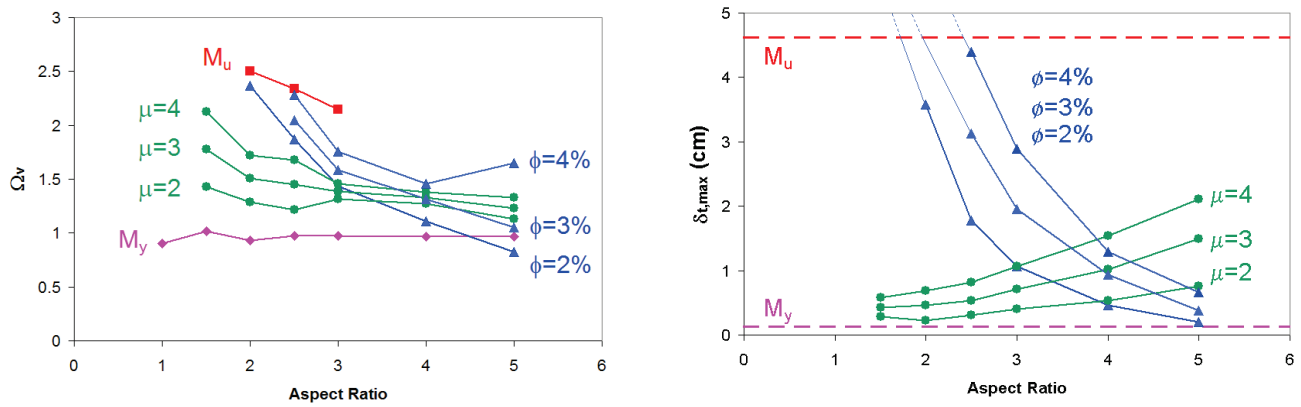

Figure A3-2 Design charts: Ω_v vs. aspect ratio (left) and deformation capacity c vs. aspect ratio (right).

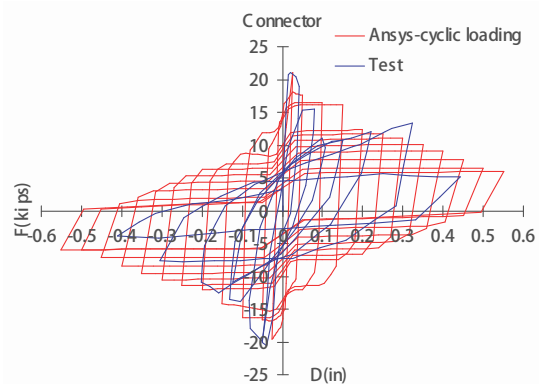
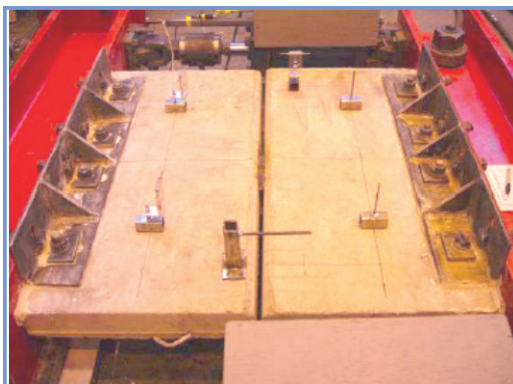

Figure A3-3 Lehigh Phase 1 test specimen and sample results for cyclic shear response (test & FE model) (right).

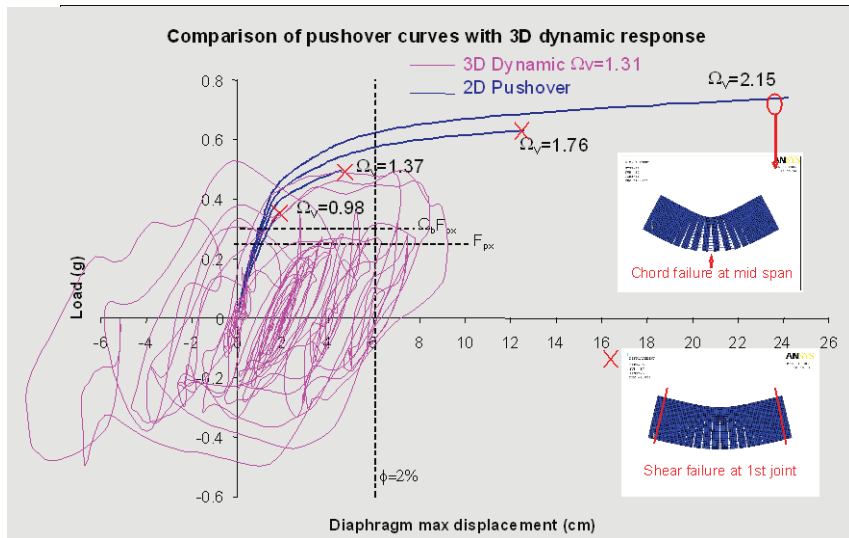

Figure A3-4 Superposition of 3D-FE global EQ demand results on 2D pushover.

Figure A3-4 shows the pushover curve global results (diaphragm force vs. diaphragm deformation) for an $AR = 3$, $L = 180'$, and the Charleston site for the critical floor from the 3D-FE model (three-story structure, $\Psi_D=1.5$) under the Charleston MCE. As can be seen, this technique allows a target displacement to be determined for the diaphragm for a given set of design parameters. For instance, use of $\Omega_v = 2.15$ (shown previously to develop the full flexure strength of the diaphragm) is unnecessary. Instead, an Ω_v somewhat greater than 1.4 is sufficient to accommodate the MCE diaphragm demands for this structure.

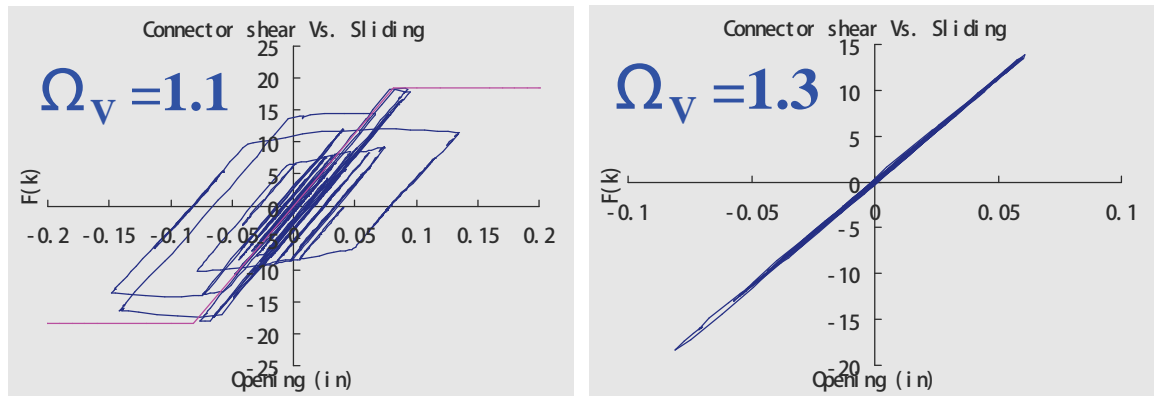

Figure A3-5 Sample results for critical shear connector, $\Psi_D = 1.5$ Berkeley MCE: (a) $\Omega_v = 1.1$, (b) $\Omega_v = 1.3$. deformation demand.

Figure A3-5 shows how the 3D-FE earthquake simulations are used to calibrate Ω_v . Shown are the response demands for the critical shear connector at the critical shear joint in the diaphragm (lower insert in Figure A3-4) for a given MCE earthquake. A shear overstrength factor Ω_v of 1.1 was used on the left side of Figure A3-5. This value was insufficient to prevent the connector from undergoing shear degradation for this single deterministic evaluation of one structure, one design and one ground motion. Raising the Ω_v value to 1.3 on the right side of Figure A3-5 was sufficient to keep this critical detail elastic throughout the MCE event.

A4 Diaphragm Detail Classification and Qualification Procedures. Proper performance of connection details is critical for the effective design and safety of precast concrete building systems. As part of the design methodology a qualification procedure is proposed that provides a systematic approach for assessing the strength and deformation capacity of embedded connections as used in conventional double tee panel systems (Ren and Naito, 2007). In addition, a recommendation is provided for categorizing connectors based on measured performance. The recommendation is limited to testing of the in-

plane and out-of-plane response of connections. A catalog of connections that have undergone this qualification and classification procedure is being compiled.

The ACI 318 code used for prestressed and non-prestressed concrete construction in the United States provides limited guidance on the design of precast connections. As noted in its Chapter 16, the various components in a connection have different properties, and those properties affect the overall behavior of the connection. Therefore, when a connection is designed using materials with different structural properties, their relative stiffness, strength, and ductility must be considered in evaluating performance.

A ductile flexural mechanism cannot form unless the connection components are designed to ensure that performance. A typical diaphragm connection consists of anchorage bars, welded plate, slug, and slug weld components. The desired connection performance is achieved by the development of a predictable yield mechanism in the anchorage bars and the protection of all other components against premature failure. For example, the weld strength must be not less than the anchorage bar strength.

Scope. The qualification document provides both a testing procedure and a classification framework that establish specific acceptance criteria for in-plane and out-of-plane performance of precast concrete diaphragm connections. For consistency with the emerging design methodology, acceptance criteria are based on prequalification of the deformation capacity. The terminology of low deformability element (LDE), medium deformability element (MDE) and high deformability element (HDE) is used to categorize the response of connections. A procedure for determining the capacity of connectors based on experimental results is described.

Testing Agency. Testing is to be performed by a recognized independent testing agency. That testing and reporting must be supervised by a professional engineer familiar with the proposed design procedure and experienced in testing and seismic structural design.

Test Modules. A minimum of two modules should be tested for each characteristic connection configuration in the prototype diaphragm. Connections are to be tested full scale unless both connections and modules have a scale large enough to represent fully the complexities and behavior of the real materials and of the load transfer mechanisms in the prototype diaphragm. For modules that are to be subjected to loadings that include in-plane loadings there must be at least two connections per module.

Reference Deformation. For each connection type, a monotonic test to failure must first be conducted to obtain a reference deformation used in subsequent cyclic tests. This reference deformation characterizes the effective yield deformation of the connection. That deformation is the deformation corresponding to the maximum load on a secant stiffness line drawn through the load and deformation for 75 percent of the maximum load.

In-plane Displacement Based Protocols. The modules are to be loaded under in-plane pure shear, pure tension, shear combined with tension, and out-of-plane shear. Tests are to be conducted under displacement control at quasi-static rates (< 0.05 in./sec) and force control. The specified testing sequence for cyclic loading is shown in Figure A4-3 where, at a ductility ratio of 1.0, the applied displacement is equal to the reference deformation.

Data Acquisition. Data must be recorded from the test such that a quantitative, as opposed to qualitative, interpretation can be made of the performance of the test module. A continuous record must be made of the force versus deformation. For in-plane tests, the axial and shear forces and the deformations transverse and parallel to the joint are to be recorded. For out-of-plane tests the vertical force and deformation are to be recorded. For static testing, data are to be recorded at a rate of 1.0 cycle/second.

Test Observations. Photographs must be taken that show the condition of the test module at the completion of testing as well as significant points throughout the testing history. Ideally, photos should be taken at the end of each group of cycles. Photos taken at points of interest, such as first cracking, yield, ultimate load and post-test, are adequate for most evaluations.

Test Report. The test report must be sufficiently complete and self-contained for a qualified expert to be satisfied that the tests have been designed and conducted in accordance with the required criteria and that the results satisfy the intent of the qualification document.

The test report must contain sufficient evidence for an independent evaluation of the performance of each test module. As a minimum, all of the following information is needed:

1. A description of the theory used to predict test module strength and deformation.
2. Details of test module design and construction, including engineering drawings.
3. Specified materials properties used for design and actual material properties obtained by testing.
4. Description of test setup, including panel details and photographs.

5. Description of instrumentation, location, and purpose.
6. Description and graphical presentation of applied loading protocol.
7. Description of observed performance, including photographic documentation, of test module condition at key loading cycles.
8. Graphical presentation of force versus deformation response.
9. Test data, report data, name of testing agency, report author(s), supervising professional engineer, and test sponsor.

Acceptance Criteria. Based on the requirements in FEMA 356 and ASCE/SEI 41-06 (ASCE/SEI41), each component is classified as a primary or secondary element or component prior to the development of component acceptance criteria and the intended response of each connection is classified as deformation-controlled (ductile) or force-controlled (nonductile). It is assumed that the connection represents a primary component of the structural system and that all actions applied to the connection can be classified as deformation-controlled or force-controlled.

As depicted in Figure A4-1 taken from ASCE/SEI 41, Type 1 and Type 2 responses are representative of ductile behavior. There is an elastic range (point 0 to point 1) followed by a plastic range (point 1 to point 3). Type 3 response is representative of a brittle or nonductile behavior. There is an elastic range (point 0 to point 1) followed by a loss of strength.

If connections display the Type 1 or Type 2 response and have $\Delta_e > 2\Delta_g$, they are classified as deformation-controlled; otherwise, they are classified as force-controlled. If connections display the Type 3 response, they are classified as force-controlled.

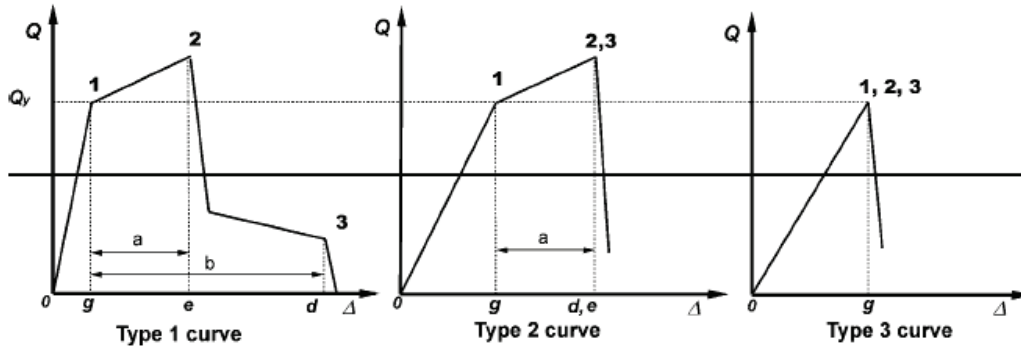

Figure A4-1 Connection classification per ASCE/SEI 41 procedures.

Deformability Category. Based on the experimental data collected to date and finite element analyses of diaphragms with differing sizes and differing configurations subject to differing earthquake records, the typical required tension opening, d_t , and shear displacement, d_v , values for deformability categorization are as shown in Table A4-1. The typical required ductility demands, μ , and joint rotation demands, ϕ , obtained from finite element analysis for diaphragms of differing sizes subject to differing earthquake records are shown in Figure A4-2. That figure illustrates how the information gained through the activities described in Section A3 are combined with the classification system described in this section. The results of Figure A4-2 are based on the data shown in Figure A3-2, cross-referenced to the requirements of the deformability categories.

Table A4-1 Typical Values for Deformability Categorization

Deformability Category	Tension deformation d_t [in.]	Shear deformation d_v [in.]
Low deformability	$0.00 < d \leq 0.15$	$0.00 < d \leq 0.30$
Medium deformability	$0.15 < d \leq 0.50$	$0.30 < d \leq 0.70$
High deformability	$D > 0.50$	$D > 0.70$

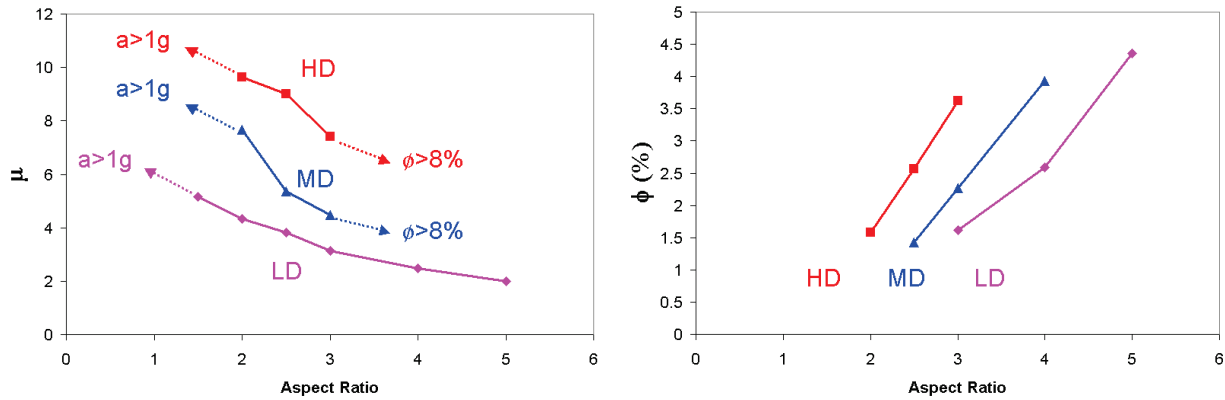

Figure 4-2 Component response classification.

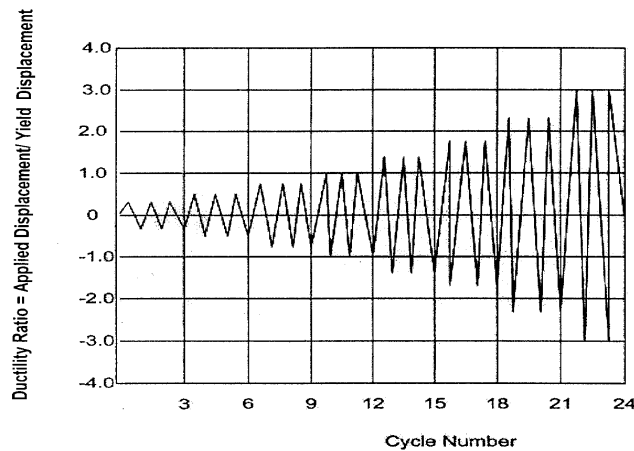

Figure A4-3 Example of specified test sequence.

A5 Diaphragm Strength and Stiffness Calculations. Several methods have been proposed for calculating the stiffness of a precast concrete diaphragm (Zheng and Oliva, 2005; Farrow and Fleischman, 2003; Nakaki, 2000). The methodology uses the spreadsheet-compatible method, developed by Wan and Fleischman (2009), that has similarities to the prior approaches.

The spreadsheet method is used to calculate the elastic stiffness of the precast diaphragm in terms of equivalent elastic modulus and shear modulus and the flexural yield strength of the precast diaphragm including any contributions from the shear reinforcement to that strength. The calculation is based on a rational method and is used in the proposed design methodology to either manually determine the diaphragm deflection or conveniently model the floors in design software. It also is used to determine the nominal strength of the diaphragm for comparison to the design moment M_u caused by $\Psi_D F_{px}$. The method is calibrated by comparisons to finite element analyses of diaphragms with differing geometries and reinforcing details. The method assumes that plane sections remain plane at joints between precast units and that the concrete in the precast unit is linear elastic and uncracked and the slab thickness is constant (i.e., contributions of washes and curbs in parking garage floors are ignored). Reinforcement in the diaphragm compression zone is ignored in determining compression stiffness (i.e., deformation is based on precast concrete unit only). The same number and type of shear connectors are used at all joints in the diaphragm and are evenly distributed along the length of the joint. Shear reinforcement is assumed to respond elastically at diaphragm yield, in accordance with the proposed design methodology (Fleischman et al., 2005a).

The method also assumes initial positions for the neutral axis and center of compression and calculates an effective flexural stiffness of the joint based on those positions and the elastic stiffness of the discrete diaphragm reinforcing elements. This value is combined with the elastic stiffness of the panel to create an overall flexural rigidity and, finally, E_{eff} . Shear stiffness of the joint and the panels are calculated and combined in a similar manner to find an effective diaphragm shear modulus G_{eff} . A similar approach is used to find the diaphragm moment strength except that discrete strengths are used instead of discrete stiffnesses and a different formulation is used to determine the position of the neutral axis at yield than in the elastic state.

The left part of Figure A4-1 compares the stiffness calculated by this method with that determined from FEM analyses (Wan and Fleischman, 2009). The right side of Figure A4-1 shows the same comparison for strength. The method shows reasonable agreement with FEM results. In addition, the methods are being calibrated using experimental results from the hybrid panel tests and will be further validated in the in the half-scale shake table.

A6 Diaphragm Load Path. Several methods exist for determining diaphragm internal load paths that are alternates to the horizontal beam approach. For example, strut and tie methods are used outside the United States (Fédération Internationale du Béton, 2003). The design methodology maintains the horizontal beam approach but recognizes alternate methods may be useful and provides for use of those methods.

The design methodology imposes structural integrity requirements. Required are:

1. Adequate anchorage of diaphragms to the primary LFRS elements, including the carrying of superimposed gravity loads and accommodating imposed rotations from walls (Menegotto, 2000);
2. Maintenance of seating for the precast units (Mejia-McMaster and Park,1994); and
3. Provision of minimum ductility requirements for joint reinforcing details.

An important component of the structural integrity measures is also the treatment of secondary members such as spandrels (see Figure A6-1 where the spandrel is SP). The effect of the spandrel (e.g., as shown in Figure A6-2) has been quantified through analytical studies (Wan and Fleischman, 2008).

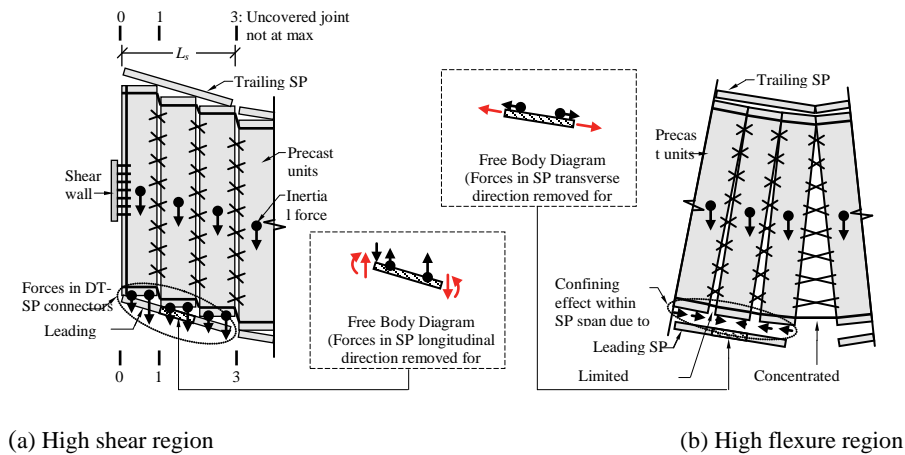

Figure A6-1 Schematics of interaction between spandrels and precast floor units.

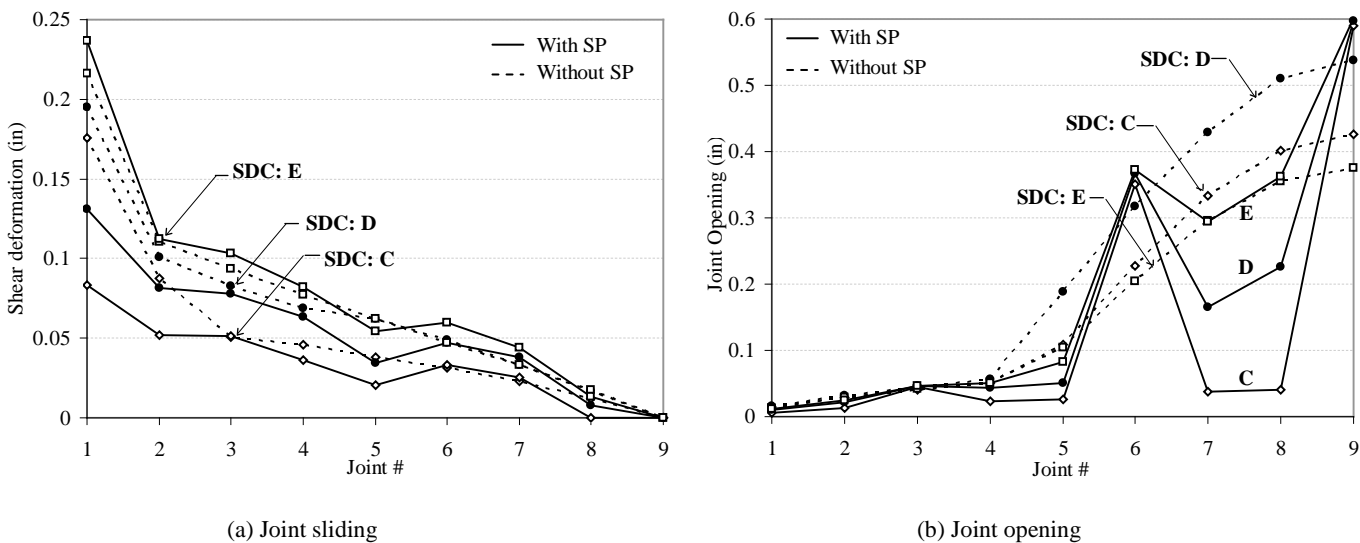

Figure A6-2 Joint deformation profiles including spandrel effects.

A7 Draft Precast Diaphragm Seismic Design Procedure. This section provides a draft design procedure showing the use of the concepts from the design methodology. The generic design terminology used previously in this document is used in this draft procedure. This outline is intended only to show one possible procedure, and this procedure will not necessarily be the final procedure recommended.

It is assumed that the following parameters of the design have been established:

1. Design base shear coefficients based on SDC and hazard maps,
2. Structural floor plan, and
3. Vertical element lateral force system (LFRS) layout.

Step 1. Calculate roof force F_i (as per 2006 IBC)

Step 2. Determine the maximum floor span, aspect ratio

- Determine the length between vertical elements of the LFRS, L_{cl} .
- Calculate effective span, $L_{eff} = \alpha L_{cl}$ where the “effective span” factor α (see Figure A7-1 for examples) takes value of
 - i. $\alpha = 1.0$ perimeter
 - ii. $\alpha = 0.7$ interior
 - iii. $\alpha = 2.0$ overhang
- Determine the diaphragm effective aspect ratio, $AR = L_{eff}/d$
- Determine the diaphragm configuration -- squat, intermediate, or long
 - Use Table A7-1
 - Use the critical AR from all floors, all spans

Step 3. Select diaphragm design option and diaphragm reinforcement

Case 1 -- No predetermined diaphragm reinforcement

A. Select diaphragm design option (EDO, BDO, RDO).

- Base on effective floor span and SDC,
- See Table A7-2.
 - Determine restrictions on design options (shaded areas are restricted in Table A7-2).

B. Determine classifications for primary diaphragm reinforcement

- For each primary diaphragm reinforcement group
 - Chord reinforcement
 - Shear reinforcement
 - Collectors/anchorage
 - Determine allowable categories
 - See Table A7-3
 - Select category (LDE, MDE, HDE)

C. Select primary diaphragm reinforcement

- Select prequalified connectors
 - Match the selected classification for each primary reinforcement group

Case 2 -- Predetermined diaphragm reinforcement

A. Determine classifications for primary diaphragm reinforcement

- For prequalified connectors - look up
- For nonprequalified connectors
 - Qualify connectors following qualification protocol of Section A4

B. Determine allowable design option

- Use Table A7-3
- Check design option with Table A7-2

Step 4. Determine diaphragm force amplification factor, Ψ_d

- Ψ_d factor based on
 - i. Design option
 - ii. L_{eff} and AR
 - iii. LFRS type
 - iv. Number of stories

- v. Building configuration
 - Take factor from Table A7-4
 - Or determine using a series of design coefficients:
 - i. Determine design force modification factors
 - $C_n = f(n)$ where n = number of stories
 - $C_{LFRS} = 1.0$ for frame and 1.5 for wall
 - $C_{config} = 1.0$
- Step 5.** Estimate diaphragm properties
 - Calculate K_{dia}
 - i. E_{eff}
 - ii. G_{eff}
 - Calculate M_y
 - i. Based on chord and shear reinforcement
 - ii. Use spreadsheet method of Section A5
 - iii. Modify values for secondary elements
- Step 6.** Estimate diaphragm target deformation
 - Estimate based on
 - i. SDC
 - ii. L_{eff} and/or AR
 - iii. LFRS type
 - iv. Ψ_d factor
 - v. Diaphragm properties
- Step 7.** Calculate shear overstrength factor, Ω_v
 - Estimate based on
 - i. L_{eff} and/or AR
 - ii. Design intent
 - iii. Diaphragm properties
 - iv. Target deformation
 - v. Shear reinforcement classification
 - Use set of tables or charts to determine Ω_v
- Step 8.** Check diaphragm-induced drifts
 - Calculate story drift in normal fashion
 - Determine drift amplifier
 - i. Based on
 - K_{dia}
 - AR, L_{eff}
 - Number of stories
 - LFRS type
 - For drift, use worst case of L_{eff} or AR.
 - For diaphragm force calculations use average among all spans

Draft Design Tables

Table A7-1 Diaphragm Configuration Designation

AR	Designation
AR < 1.5	Squat (SQT)
1.5 < AR < 3.0	Intermediate (INT)
AR > 3.0	Long (LNG)

Table A7-2 Applicability of Diaphragm Design Options

Configuration	Seismic Design Category								
	A, B			C, D			E, F		
	SQT	INT	LNG	SQT	INT	LNG	SQT	INT	LNG
Elastic (EDO)	●	●	○	●	○		○	▨	▨
Basic (BDO)		○	●	○	●	●	●	○	▨
Relaxed (RDO)								●	▨

Key: Recommended ● Alternative ○ Allowable ○ Not allowed ▨

Table A7-3 Applicability of Diaphragm Detail Classification

Classification	Seismic Design Category								
	Chord in Tension			Shear in Tension			Shear in Shear		
	LDE	MDE	HDE	LDE	MDE	HDE	LDE	MDE	HDE
Elastic (EDO)	●	○	○	●	○	○	●	○	
Basic (BDO)	▨	○	●	○	●	●	▨	●	○
Relaxed (RDO)	▨	▨	●	▨	▨	●	▨	●	○

Key: Recommended ● Alternative ○ Allowable ○ Not allowed ▨

Table A7-4 Diaphragm Force Amplification Factor

A. Specify strength reduction and detailing requirements for each classification

Classification	OD		ID		SD		
	Reinforcement	ϕ	detailing	ϕ	detailing	ϕ	detailing
Collector		0.75	-	0.75	Regular ^a	0.6	Special ^a
Chord		0.9	-	0.9	Regular	0.9	Special
Web	Shear	0.75	-	0.75	-	0.6	-
	Tension	- ^b	Type A	-	Type B	-	Type C

B. Select approach for force resistance mechanisms.

Web Reinforcement Tensile Characteristics			Type A		Type B		Type C	
			A_F	δ_t	A_F	δ_t (in) ^c	A_F	δ_t (in) ^c
Tension Compliant ^d			-	-	1.2	0.3	1.4	0.6
Tension Resistant ^d	Ductile	$\phi = 0.9$			1.2	0.2	1.4	0.5
	Elastic	$\phi = 0.6$	-	-	1.25	-	1.5	0.3
Strut and Tie								

C. Define diaphragm stiffness requirement

Diaphragm Stiffness Required for		Serviceability Deflection	Diaphragm Force Levels	Lateral System Force Distribution	Gravity System Seismic Drifts
Design procedure can use		Diaphragm clear span between lateral system elements	(Absolute) Diaphragm Stiffness Value	Stiffness relative to the lateral system or diaphragm flexibility index	Diaphragm Deflection Calculation
Diaphragm stiffness based on		Diaphragm span	Boundary conditions	Construction type (topped/untopped)	Reinforcement size, type, spacing
Diaphragm Stiffness Components	Contributor	Chord steel, pour strips, bond beams	Welded wire fabric	Flange-to-flange connectors	Shear keys
	Components	Flexure, dowel	Shear-friction, flexure	Shear, flexure (non-tension compliant)	Shear

^a Regular and special detailing differ in requirements for spacing, cover, transverse reinforcement etc to obtain two levels of ductility for collector and chords.

^b See Table A7-4B, Web Reinforcement Tensile Characteristics.

^c $\delta_u > \delta_t$ where δ_t is the target tension displacement and δ_u is the failure displacement demand as defined in the qualification testing protocol (see Table A7-5). These values are being determined by UCSD and UA research on global/local ductility demands.

^d See stiffness requirements (Table A7-4C).

Table A7-5 Qualification Testing
(Testing Protocol - Connector tension capacity to be determined through cycling component testing)

	Shear Loading	Tension Loading	Shear/Tension Loading	Capacity
Monotonic	1 test ^a	1 test ^a	-	δ_u ^d
Cyclic	1 test ^b	1 test ^b	2 test ^c	δ_u ^d

^a To determine monotonic envelope

^b Displacement control loading, cycled twice at ductility ratios of 0.75, 1.0, 1.5, 2.0, 3.0, etc.

^c Proportional components of equal tension/compression and reversing shear.

^d δ_u is defined as either the displacement of first fracture of weld or component; displacement of anchor pullout; or displacement corresponding to strength degradation at which response drops below 80 percent of the nominal strength.

Table A7-6 Prequalified Details

Construction Type	Welded wire fabric ^a			Slab bar reinforcement ^b			Flange Connector			Shear Key		
	A	B	C	A	B	C	A	B	C	A	B	C
Topped Composite	-	6x6	10x10	-	reg.	special	-	DT-PQB ^c	DT-PQC ^c	-	HC-PQB ^c	HC-PQC ^c
Topped Noncomposite	-	6x6	10x10	-	reg.	special						
Untopped							-	DT-PQB	DT-PQC	-	HC-PQB	HC-PQC

^a Mesh matrix geometry, wire size deformed and plain that meets the B and C detail requirements in Table A7-6 as determined by the Lehigh research tests.

^b Embedded slab reinforcement to follow detailing requirements as described in Table A7-4.

^c These represent details that can be prequalified by meeting the criteria determined in the research. The data can originate from previous tests, tests in the Lehigh pilot program or other parallel testing programs (Pincheira et al., 2005). For instance, DT-PQB may contain standard hairpin flange-to-flange connections; DT-PQC may contain proprietary connectors such as the JVI connector (Oliva, 2000, Shaikh and Feile, 2002). The HC-PQC could for instance include serrated hollow-core units studied by Menegotto, 2000.

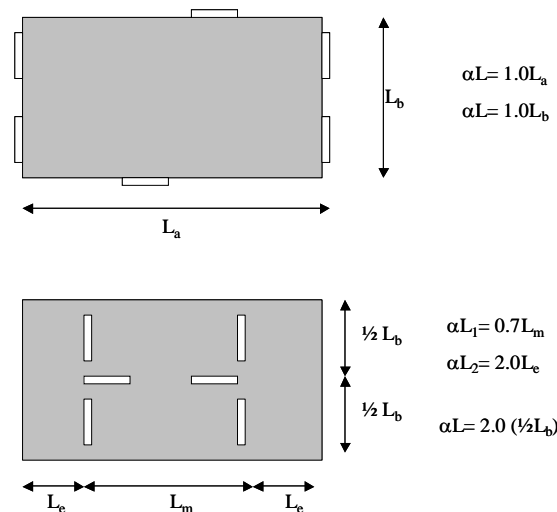

Figure A7-1 Example.

REFERENCES

ACI Committee 318. 2008. *Building Code Requirements for Structural Concrete*, ACI 318-08, and *Commentary*, ACI R318-08. American Concrete Institute, Farmington Hills, Michigan

American Society of Civil Engineers. 2007. *Seismic Rehabilitation of Existing Buildings*, ASCE/SEI 41-06. ASCE, Reston, Virginia.

Building Seismic Safety Council. 2000. *NEHRP Recommended Provisions for Seismic Regulations for New Buildings and Other Structures*, FEMA 369 (Commentary). Federal Emergency Management Agency, Washington, DC, 2000.

DSDM. 2006. *Year 2 Report to National Science Foundation: GOALI Project "Development of a Precast Floor Diaphragm Seismic Design Methodology (DSDM)*, August 17.

- Eberhard, M. O., and M. A. Sozen. 1993. "Behavior-Based Method to Determine Design Shear in Earthquake-Resistant Walls," American Society of Civil Engineers, *Journal of Structural Engineering*, 119(2): 619-640.
- Earthquake Engineering Research Institute (EERI). 1994. *Northridge Earthquake, January 17, 1994, Preliminary Reconnaissance Report*. EERI, Oakland, California.
- Farrow, K. T., and R. B. Fleischman. 2003. "Effect of Dimension and Construction Detail on the Capacity of Diaphragms in Precast Parking Structures," *PCI Journal*, 48(5): 46-61.
- Federal Emergency Management Agency. 2000. NEHRP Commentary on the Guidelines for the Seismic Rehabilitation of Buildings."
- Fédération Internationale du Béton, Commission 7 Task Group. 2003. *State-of-the-Art Report on the Seismic Design of Precast Concrete Building Structures*, edited by Robert Park.. Sprint-Digital-Druck, Stuttgart, Germany.
- Fleischman, R. B., and G. Wan. 2007. "Appropriate Overstrength of Shear Reinforcement in Precast Concrete Diaphragms", American Society of Civil Engineers, *Journal of Structural Engineering*, Special Issue: Precast/Prestressed Concrete Structures under Natural and Human-Made Hazards, edited by Y. Kurama 133(11); 1616-26
- Fleischman, R. B., C. J. Naito, J. Restrepo, R. Sause, and S. K. Ghosh. 2005a. "Seismic Design Methodology for Precast Concrete Diaphragms, Part 1: Design Framework," *PCI Journal*, 50(5): 68-83.
- Fleischman R. B., C. J. Naito, J. Restrepo, R. Sause, S. K. Ghosh, G. Wan, M. Schoettler, and L. Cao. 2005b. "Seismic Design Methodology for Precast Concrete Diaphragms, Part 2: Research Program," *PCI Journal*, 51(6): 2-19.
- Fleischman, R. B., and K. T. Farrow. 2003. "Seismic Design Recommendations for Precast Concrete Diaphragms in Long Floor Span Construction," *PCI Journal*, 48(6): 46-62.
- Fleischman, R. B., K. T. Farrow, and K. Eastman. 2002. "Seismic Performance of Perimeter Lateral-System Structures with Highly Flexural Diaphragms," *Earthquake Spectra*, 18(2).
- Fleischman, R. B., and K. T. Farrow. 2001. "Dynamic Response of Perimeter Lateral-System Structures with Flexible Diaphragms," *Earthquake Engineering and Structural Dynamics*, 30(5): 745-763.
- Fleischman, R. B., R. Sause, S. Pessiki, and A. B. Rhodes. 1998. "Seismic Behavior of Precast Parking Structure Diaphragms," *PCI Journal*, 43(1):38-53.
- Fleischman, R. B., R. Sause, A. B. Rhodes, and S. Pessiki. 1996. "Seismic Behavior of Precast Parking Structure Diaphragms," in *Proceedings, XIV ASCE/SEI Structures Congress, Building an International Community of Structural Engineers*, Vol. 2, edited by S. K. Ghosh, Chicago, Illinois, April 15-18, pp. 1139-1146.
- Hall, J. F. (Editor). 1995. "Northridge Earthquake Reconnaissance Report," *Earthquake Spectra*, 11, Supplement C(1): 523.
- Hawkins, Neil M., and S. K. Ghosh. 2000. "Proposed Revisions to 1997 NEHRP Recommended Provisions for Seismic Regulations for Precast Concrete Structures: Part 3 – Diaphragms," *PCI Journal*, 45(6).
- International Code Council. 2006. *International Building Code*, 2006 Edition, International Code Council, Inc., Falls Church, Virginia.
- Iverson, J. K., and N. M. Hawkins. 1994. "Performance of Precast/Prestressed Concrete Building Structures During Northridge Earthquake," *PCI Journal*, 39(2): 38-55.
- Ju, S.H., and M. C. Lin. 1999. "Comparison of Building Analyses Assuming Rigid or Flexible Floors," *ASCE/SEI Journal of Structural Engineering*, 125(25).
- Kao, G. 1998. "Design and Shake-Table Tests of a Four-Storey Miniature Structure Built with Replaceable Plastic Hinges," M.E. Thesis, Department. of Civil Engineering, University of Canterbury, Christchurch, New Zealand.
- Lee, H. J., and D. A. Kuchma. 2007. "Seismic Overstrength of Shear Walls in Parking Structures with Flexible Diaphragms," *Journal of Earthquake Engineering*, 11(1): 86-109.
- Lee, H. J., D. A. Kuchma, and M. A. Aschheim. 2007. "Strength-Based Design of Flexible Diaphragms in Low-Rise Structures Subjected to Earthquake Loading," *Engineering Structures*, 29(7):1277-1295.
- Lee, H. J., M. A. Aschheim, and D. Kuchma. 2007. "Interstory Drift Estimates for Low-Rise Flexible Diaphragm Structures," *Engineering Structures*, 29(7):1375-1397.
- Mejia-McMaster, J. C., and R. Park. 1994. "Tests on Special Reinforcement for End Support of Hollow-Core Slabs," *PCI*

Journal, 39(5): 90-105.

Menegotto, M. 2000. "Precast Floors Under Seismic Action," in *Proceedings, The Second International Symposium on Prefabrication*, Helsinki, Finland, May 2000.

Naito, C., and L. Cao. 2004. "Precast Diaphragm Panel Joint Connector Performance," Paper 2722 in *Proceedings, 13th World Conference on Earthquake Engineering*, Vancouver, Canada

Naito, C., W. Peter, and L. Cao. 2006. "Development of a Seismic Design Methodology for Precast Diaphragms, Phase 1 Summary Report," ATLSS Report 06-03, Lehigh University, Bethlehem, Pennsylvania.

Nakaki, S. D. 2000. "Design Guidelines for Precast and Cast-in-Place Concrete Diaphragms," *1998 NEHRP Professional Fellowship Report*, Earthquake Engineering Research Institute.

Oliva, M. G. 2000. Testing of the JVI Flange Connector for Precast Concrete Double-Tee Systems. Structures and Materials Test Laboratory, College of Engineering, University of Wisconsin.

Pincheira, J. A., M. G. Oliva, and W. Zheng. 2005. "Behavior of Double-Tee Flange Connectors Subjected to In-Plane Monotonic and Reversed Cyclic Loads," *PCI Journal*, 50(6): 32-54.

Ren, R., and C. J. Naito. 2007. "Acceptance Criteria for Precast Concrete Diaphragm Connectors Based on Structural Testing," ATLSS Report 07-XX, Lehigh University, Bethlehem, Pennsylvania.

Rodriguez, M., J. I. Restrepo, and A. J. Carr. 2001. "Earthquake Induced Floor Horizontal Accelerations in Buildings," *Earthquake Engineering and Structural Dynamics*, 31.

Shaikh, A. F., and E. P. Feile. 2004. "Load Testing of a Precast Concrete Double Tee Flange Connector," *PCI Journal*, 49(3): 84-94.

Standards New Zealand. 1997. "Concrete Structures Standard—The Design of Concrete Structures" and "Commentary on the Design of Concrete Structures," NZS 3101, Parts 1 and 2, 1995, and "Amendment 1 to NZS 3101, 1997." Wellington, New Zealand.

Tena-Colunga, A., and D. P. Abrams. 1992. *Response of an Unreinforced Masonry Building During the Loma Prieta Earthquake*, Structural Research Series 576, Department of Civil Engineering, University of Illinois at Urbana-Champaign.

Wan, G., and R. B. Fleischman. 2009. "A Rational Method for Calculating the Service Stiffness and Yield Strength of Precast Floor Diaphragms," in preparation for submission to *PCI Journal*.

Wan, G., and R. B. Fleischman. 2008. "Effect of Spandrel Beam to Double Tee Connection Characteristic on Precast Diaphragm Response," submitted to the *ASCE/SEI Structures Journal*.

Wood, S. L., J. F. Stanton, and N. M. Hawkins. 2000. "New Seismic Design Provisions for Diaphragms in Precast Concrete Parking Structures," *PCI Journal*, 45(1): 50-65.

Wood, S. L., J. F. Stanton, and N. M. Hawkins. 1995. "Performance of Precast Parking Garages During the 1994 Northridge Earthquake," in *Proceedings, XIII ASCE/SEI Structures Congress, Restructuring: America and Beyond*, Vol. 1, New York, New York, pp. 563-566.

Zheng, W., and M. G. Oliva. 2005. "A Practical Method to Estimate Elastic Deformation of Precast Pretopped Double Tee Diaphragms," *PCI Journal*, 50(2): 44-55.

Resource Paper 11

SHEAR WALL LOAD-DEFLECTION PARAMETERS AND PERFORMANCE EXPECTATIONS

Light-frame shear wall buildings of wood and cold formed steel (CFS) exhibit both similarities and differences in design, construction, and anticipated seismic performance. This resource paper is intended to identify anticipated load-deflection parameters and define performance expectations towards which both wood and CFS standard committees can steer future standard updates and future detailing recommendations. It was developed by a joint task group of TS6, Steel Design, and TS7, Wood Design, for consideration by the design community.

Discussed are wood and cold formed steel (CFS) light-frame buildings with seismic-force-resisting systems designed in accordance with the 2006 International Building Code and ASCE/SEI 7-05 (ASCE/SEI 7). The main objective of the ASCE/SEI 7 seismic design provisions is to protect the health, safety, and welfare of the general public by minimizing the earthquake-related risk to life. Structural and nonstructural damage can be expected as a result of the “design ground motions” since ASCE/SEI 7 allows inelastic response in the structural system. For ground motions in excess of the design levels, the intent of these design provisions is for the structure to have a low likelihood of collapse.

RECOMMENDATIONS

1.1 Systems with $R = 6.5$ and 7.0 . This section addresses wood and CFS light-frame shear wall systems with wood structural panel sheathing. Bearing wall systems are assigned a seismic response modification coefficient, R , of 6.5 and building frame systems, an R of 7.0. Details of design and construction are to be in accordance with the *Special Design Provisions for Wind and Seismic* (SDPWS) (AF&PA, 2005) for wood construction, and *AISI S213-07, Standard for Cold-Formed Steel Framing – Lateral Design* (AISI, 2007), for CFS construction.

1.1.1 Analysis Model. ASCE/SEI 7-05 equivalent lateral force or simplified seismic design procedures for determination of seismic demand are intended to be used with an analysis model that includes designated portions of the seismic-force-resisting systems sheathed with wood structural panels.

1.1.2 Vertical Shear Wall Element Parameters. Table 1-1 documents observed load deflection behavior and related parameters in site-built wood structural panel shear walls. Behavior that varies from these parameters is outside the scope of this paper. See Figure 1-1 for an illustration of these parameters.

Table 1-1 Vertical Shear Wall Element Parameters^a

Vertical Shear Wall Element Parameter	Value
1. Ratio of peak capacity (V_U) to ASD design capacity (V_{ASD})	2.5 to 5.0 ^b
2. Minimum ratio of drift at 0.80 V_U post peak capacity ($\Delta_{0.8V_U}$) to drift at ASD design capacity (Δ_{ASD})	11
3. Minimum drift at 0.80 V_U post peak capacity ($\Delta_{0.8V_U}$)	0.028 h^c
4. Drift at peak element strength (V_U)	0.01 h to 0.04 h
5. Minimum equivalent viscous damping in a single loading cycle reaching peak strength (V_U)	15 percent of critical

^a h = story clear height.

^b Where the ratio exceeds 5, vertical and lateral element detailing must consider the effect of additional overstrength.

^c This value is the minimum drift at 0.80 V_U post peak capacity for elements with a drift at peak element strength less than 0.028 h . This minimum drift at residual strength should always be greater than the drift at peak strength (see Figure 1-1).

The parameters given in Table 1-1 are derived from wood structural panel sheathed shear walls with wood framing tested using the CUREE protocol (CUREE, 2001a). In particular, Parameters 1 through 3 are taken from a database of 48 wood-frame shear walls assembled by the AC322 Seismic Equivalency Task Group (2007). Data from the following test reports are included: Martin, Skaggs and Keith (2005), Martin (2004), Martin and Skaggs (2003), Martin (2002), Rosowsky, Elkins and Carroll (2004), and Pardoen et al. (2003). Variation in the parameters is known to occur within the broad range of wood structural panel shear walls based on differences in framing type, framing design, detailing, fasteners, and with testing

protocols that vary from the CUREE protocol such as the sequential phased displacement protocol (SPD) (SEAOSC, 1997). See Section C1.1.2 for further discussion.

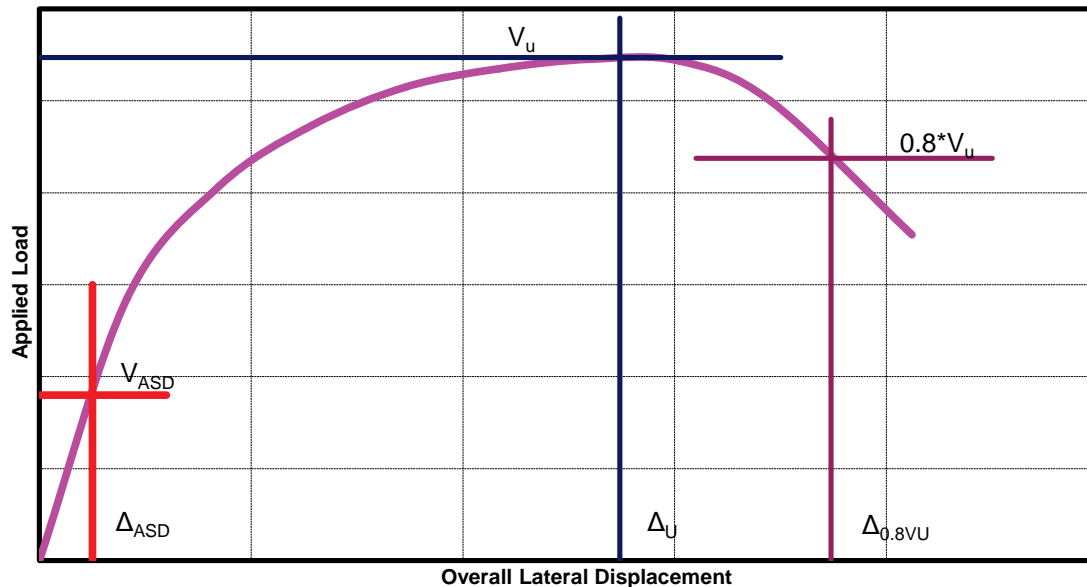

Figure 1-1 Vertical shear wall element parameters.

1.1.3 Vertical Shear Wall Element Performance Expectations. The following recommendations for vertical shear wall elements are intended to allow development of a yield mechanism in the sheathing to framing connection to enable performance as specified in Section 1.1.2:

1. Shear wall shear capacity is intended to act as the weak link in the shear wall assembly.
2. Vertical boundary member tension strength should not act as a weak link in the shear wall assembly. Boundary member design for tension should address reduced net sections and accumulated tension from multiple stories.
3. Vertical boundary member compression strength should not act as a weak link in the shear wall assembly. Boundary member design for compression should include consideration of member buckling, and transfer of compression loads in and out of compression members.
4. Boundary member tension connections between elements (i.e., floor-to-floor) and to the foundation should not act as a weak link in the shear wall assembly.
5. Shear transfer connections between elements and to the foundation should not act as a weak link in the shear wall assembly.
6. Collector members, splices in collectors, and connection of collectors to vertical shear wall elements should not act as a weak link in the shear wall assembly.
7. Boundary member and connection deformation should be accounted for in shear wall design and detailing, including connections floor-to-floor and to the foundation.

1.1.4 Estimated Peak Unit Shear Capacity, v_u . For CFS elements, the shear wall peak unit shear capacity, v_u , is intended to be determined from monotonic or cyclic (CUREE, 2004) testing. If the SPD protocol is used to determine the nominal unit shear strength for wood structural panel shear walls with CFS framing, the unit shear strength should be increased by 20 percent (Boudreault, 2005). In addition, if the stabilized backbone curve is used, the unit shear strength should be increased another 10 percent. If the CUREE protocol is used, no adjustment is required. As an alternative, the shear wall peak unit shear capacity, v_u , may be estimated as the AISI tabulated nominal seismic unit shear strength times 1.3.

For wood elements, the shear wall peak unit shear capacity, v_u , is intended to be determined from monotonic or cyclic (CUREE, 2004) testing but also may be taken from nominal unit shear values set forth in Table 4.3A, Column B, of AF&PA *Special Design Provisions for Wind and Seismic* (SDPWS).

1.2 Systems with $R = 2.0$ and 2.5. In ASCE/SEI 7, wood and CFS light-frame shear walls are assigned seismic response modification coefficients, R , equal to 2.0 or 2.5 if they are sheathed with other than wood structural panels or steel sheets. Sheathing materials may include gypsum wallboard, interior plaster, exterior three-coat Portland cement plaster (stucco),

fiberboard, particleboard, and diagonal lumber sheathing when permitted by the applicable AF&PA or AISI standard. This section applies only if the $R = 2.0$ or 2.5 system is used in the building direction under consideration in each story from the level under consideration to the roof; mixed seismic-force-resisting systems are beyond the scope of this paper.

1.2.1 Analysis Model. ASCE/SEI 7 equivalent lateral force or simplified seismic design procedures for determination of seismic demand are intended to be used with an analysis that includes designated portions of the seismic-force-resisting system. All vertical elements considered in the analysis model are intended to meet the aspect ratio, design, and detailing requirements of the applicable AF&PA or AISI standard.

1.2.2 Vertical Shear Wall Element Parameters. Table 1-2 documents observed load deflection behavior and related parameters in site-built light-frame shear walls sheathed with other than wood structural panels (and other than sheet steel). Parameters are given in Table 1-2 for both the CUREE protocol and the SPD protocol. Behavior that varies from these parameters is outside the scope of this paper.

Table 1-2 Vertical Shear Wall Element Parameters^a

Vertical Shear Wall Element Parameter	Value
1. Minimum drift (Δ_U) at peak element strength (V_U)	$0.0025 h$
2. Minimum ratio of peak capacity (V_U) to ASD design capacity (V_{ASD})	2.0

^a h = story clear height.

1.2.3 Vertical Shear Wall Element Performance Expectations. Adequate seismic performance of buildings designed using shear walls sheathed with other than wood structural panel shear walls (or steel sheets, also an $R = 6.5$ system) is almost entirely dependent on shear wall element strength rather than on ductility. Building drift demands are anticipated to be significantly less than those for $R = 6.5$ or 7 buildings. To accommodate this behavior, it is recommended that the nominal strength of the following be adequate to match or exceed the peak capacity, V_U , of the shear wall sheathing:

1. Boundary member tension connections between elements and to the foundation.
2. Shear transfer between elements and to the foundation.
3. Collector member splices and connections to vertical elements.
4. Members and connections supporting discontinued shear walls or frames (revises ASCE/SEI 7 Section 12.3.3.3)

1.3 Details of Construction

Seismic performance of light-frame shear walls requires attention to details of construction and quality assurance. Provisions for construction and quality assurance are incorporated in the AF&PA, AISI, and ASCE/SEI 7 standards and the model building codes.

COMMENTARY

This resource paper was developed by a joint task group of TS6 and TS7 members in recognition of both the similarities and the differences between wood and cold formed steel (CFS) light-framed shear wall systems with wood structural panel sheathing. Because of differences in material behavior and cyclic load response, a simple transcription of design requirements for wood to steel and steel to wood is not practical. The approach taken is to identify performance expectations for light-frame shear wall seismic-force-resisting systems; material specific differences in design method can then be accommodated in future development of approaches to achieving the desired performance. This paper includes performance expectations for those systems currently included in ASCE/SEI 7 – that is, systems with $R = 6.5$ and 7 as well as systems with $R = 2$ and 2.5 . Questions regarding appropriateness of the assigned R factors are beyond the scope of this paper. Steel sheet shear walls also are beyond the scope of this paper.

C1.1 Systems with $R = 6.5$ and 7.0

Section 1.1 addresses wood structural panel sheathed shear wall systems. It is intended that, except as specifically addressed in this paper, these systems be designed in accordance with ASCE/SEI 7, AF&PA *Special Design Provisions for Wind and Seismic* for wood construction, and AISI S213-07, *North American Standard for Cold-Formed Steel Framing – Lateral Design*, for CFS construction. Because the R factors assigned to these systems are relatively high, significant inelastic behavior is anticipated in design level seismic events, including potential for loading in the range of post-peak-capacity deflections.

The typical wood light-frame building responds to a seismic event by racking the wall elements while the floor and roof diaphragms remain close to elastic. Consequently, the walls largely determine the seismic response characteristics of light-frame construction. In $R = 6.5$ and 7.0 wood structural panel shear wall systems, sheathing is most commonly installed in 4 foot by 8 to 10 foot sheets and fastened to wall framing with nails (for wood frame) and screws (for CFS). The primary source of seismic drift and energy dissipation of wood shear walls is the bending and yielding of the shear wall sheathing to framing fasteners around the perimeter of each sheathing panel accompanied by slip between the sheathing and framing. In CFS frame shear walls, drift and energy dissipation are generally related to the tilting (rotation) of the sheathing fasteners as well as the bearing deformations in the wood structural panel or steel adjacent to the connections; again, the deformations at the sheathing fasteners are accompanied by slip between the sheathing and framing.

This paper addresses only the combinations of sheathing and fastening currently included in the AF&PA and AISI standards. This is because the cycled load behaviors of these combinations are known to provide for required inelastic behavior. Other combinations of sheathing and fastening and other methods of attachment should be tested in reverse-cyclic loading.

C1.1.1 Analysis Model. Virtually all wood or CFS shear wall buildings are designed for seismic loads using the ASCE/SEI 7 equivalent lateral force method or simplified method. Analysis for these systems includes vertical wall elements that are designated to be part of the seismic-force-resisting system. For $R = 6.5$ and 7 systems, all designated shear walls will be sheathed with wood structural panel sheathing. Recent studies have confirmed that, for these buildings, the strength and stiffness contribution of finish materials and partition walls plays a significant role in the seismic performance of these buildings. Despite this understanding, analysis models used to evaluate and distribute seismic demand are intended to include only designated wood structural panel shear walls. This does not preclude consideration of the effect of walls sheathed with other than wood structural panels when evaluating a building for presence of structural irregularities.

C1.1.2 Vertical Shear Wall Element Parameters The parameters addressed in this section are intended to allow discussion of hysteretic behavior for site-built wood structural panel shear walls from which performance expectations and detailing recommendations can follow. The parameters in Table 1-1 were accepted by the authors of this paper for wood structural panel shear walls with wood framing; they were accepted as interim values for wood structural panel shear walls with CFS framing. A database of testing with CFS members was not accepted by the AC322 Seismic Equivalency Task Group in time for consideration in this paper.

The parameters are not intended to be used to assign R factors to vertical shear wall systems nor are they intended to address prefabricated shear wall elements. Vertical elements whose parameters do not conform to those described in Table 1-1 are outside the scope of this paper.

Parameters 1 through 3 in Table 1-1 mirror parameters recommended by the AC322 task group (AC322, 2007). The values are derived from a group of 48 wood light-frame shear walls sheathed with wood structural panel sheathing nailed to wood framing and tested using the CUREE protocol. The tabulated numbers for parameters two and three are the average values minus one standard deviation. Further commentary on the Table 1-1 parameters follows:

1. Parameter 1 -- Provision of overstrength beyond ASD design capacity is understood to be fundamental to earthquake performance of buildings braced with wood structural panel shear walls.
2. Parameter 2 -- Deformation capacity at peak strength well beyond deformation capacity at design level is understood to be fundamental to earthquake performance of buildings braced with wood structural panel shear walls. In this parameter, 80 percent post-peak capacity is specified.
3. Parameter 3 -- Testing and analysis suggests that wood structural panel sheathed shear walls are capable of supporting post-peak loading. At a post-peak capacity of 80 percent of peak, the shear wall element drift of not less than $0.028h$ is expected.
4. Parameter 4 -- The range of vertical element drift recognizes both the allowable story drift permitted by ASCE/SEI 7 and some variation of vertical shear wall elements above and below this drift.
5. Parameter 5 -- The criterion looks at one cycle in which the shear wall element reaches peak strength. If the CUREE protocol is used, this would be anticipated to be in the range of the 6th to 8th loading cycle. The areas within the curve for both positive and negative excursions are intended to be summed and an equivalent viscous damping ratio calculated. See Filiatrault et al. (2003) for details of equivalent viscous damping calculation.

See Line, Waltz, and Skaggs (2008) for further discussion of the AC322 parameters. The parameters currently included do not consider degrading reloading stiffness. This parameter might be considered for inclusion at a future time.

C1.1.3 Vertical Shear Wall Element Performance Expectations. Performance expectations described in this section support the sheathing-to-framing fastening as the primary source of inelastic behavior and energy dissipation in the vertical shear wall elements. Failure of the boundary members or connections addressed in Section 1.1.3, Items b, c, d, e, and f could

cause a more critical and possibly sudden and brittle failure of the vertical shear wall element. In general, further study is needed to determine whether or not the desired behavior requires detailing provisions beyond those currently required by ASCE/SEI 7, SDPWS, and AISI S213.

Item 2, vertical boundary member tension design -- Tension boundary members should be sized such that they are not the weak link in the shear wall assembly. For wood boundary members, it is recognized that most members will be stronger than the calculated nominal capacity due to the 5 percent basis of reference wood member strength properties in underlying design and product standards. It is also recognized that tension post capacity in use will be sensitive to placement of knots and other characteristics because the strength controlling characteristic of the wood member is not always located in the area of maximum tension force.

This section also includes a reminder that net tension at reduced net sections and accumulated tension from multiple stories need to be considered. In addition, tension member design should include consideration of flexure due to the eccentricity of the tie-down load.

Item 3, vertical boundary member compression design -- Compression boundary members should be sized such that they are not the weak link in the shear wall assembly. See also comments on tension design above.

Item 4, boundary member tension connections between elements and to the foundation -- Tension connections for boundary members are required as part of a complete load path through the building. This includes both tension connections from boundary members above to boundary members below and anchorage to the foundation. Tension connections use tie-down brackets, steel straps, or continuous rod or cable systems. Again, the tension connection should not be the weak link in the shear wall element.

Item 5, shear transfer connections -- The lateral forces at the foundation are resisted by a distributed connection along the shear walls oriented parallel to and in the plane of the load. These connections are most commonly anchor bolts at foundation sill plates and nailing or sheet metal angles at framed floors. This connection is typically designed to be independent of the connections used to resist the overturning forces (i.e., resists only horizontal shear and not tension due to overturning). This connection should be designed such that it is not the weak link in the shear wall system.

Item 6, collectors -- There has been a lack of observed failures in light-frame collector elements. To ensure that the failure is not in the collector, however, the connection of the collector to the shear wall or the splice of the collector should be designed such that they are not the weak link in the shear wall system.

Item 7, boundary member and connection deformation -- Excessive deformation of boundary members and their connections can lead to the premature failure of sheathing to framing fastening due to large imposed deformations. See the discussion in Commentary Sections 12.2.3.11 and 12.2.3.12 of the 2003 *NEHRP Recommended Provisions* (BSSC, 2003). Deformation in top plates, collectors, and shear transfer connections is not currently specifically discussed. Consideration might be given the these sources of deformation in the future.

C1.1.4 Estimated Peak Unit Shear Capacity, v_U . It is intended that estimated values of the peak unit shear capacity, v_U , be used in evaluating the performance expectations of Section 1.1.3. Because the referenced testing of wood-frame shear walls uses the CUREE protocol, it is not anticipated that conversion of peak unit shear capacity from other protocols will be needed. Under no circumstances is it intended that tests conducted using the SPD protocol be converted to compare to the five parameters of Table 1-1 since accurate adjustments of all five parameters are not available.

C1.2 Systems with $R = 2.0$ and 2.5

In ASCE/SEI 7, wood and CFS light-frame walls are assigned seismic response modification coefficients, R , equal to 2.0 or 2.5 if they are sheathed with other than wood structural panels or steel sheets. Specifically, R , C_d , and Ω_0 , are 2.0, 2.5, and 2.0 for bearing wall systems and 2.5, 2.5, and 2.5 for building frame systems. This commonly includes sheathing with gypsum wallboard, interior plaster, exterior three-coat Portland cement plaster (stucco), particle board, fiberboard and diagonal lumber sheathing. This may also include wood structural panel sheathing used alone or in combination with other sheathing materials.

Adequate seismic performance of buildings designed using shear walls sheathed with other than wood structural panels (or sheet steel) is almost entirely dependent on shear wall element strength rather than ductility. As ductility is replaced with strength, reliability of the bracing system becomes highly dependent on adequate capacity, adequate detailing, and adequate understanding of seismic demand. For the materials currently included in the AISI and AF&PA standards, there is a level of comfort with design for $R = 2$ or 2.5 systems. This comes both from a history of design of these systems using $R = 4.5$ under the Uniform Building Code (ICBO, various) and recent analytical studies suggesting generally adequate performance with $R = 2$ design (ATC, 2007).

C1.2.1 Analysis Model. Since a low R value is being utilized, the level of inelastic response is assumed to be lower than if an $R \geq 6.0$ were to be used. Therefore, the combination of the relatively brittle finish materials with the more ductile wood structural panel walls is allowed, provided the R of 2 or 2.5 is used for all vertical elements. This level of design is often used when the building design has a relatively large number of interior walls that will be used as resistance since interior walls are usually sheathed with brittle materials such as gypsum wallboard.

C1.2.2 Vertical Shear Wall Element Parameters. The vertical shear wall elements included in this group have widely varying load-deformation characteristics. In general, however, it is anticipated that they have much less ductility and deformation capacity and more rapid post-peak drop in capacity than wood structural panel sheathing.

For Table 1-2, Parameter 1, the minimum drift criterion of $0.0025h$ recognizes that a building braced with these shear wall types will have measurable drift during design level earthquake loading.

For Table 1-2, Parameter 2, it is anticipated that shear walls using sheathing materials currently assigned $R = 2$ or 2.5 have ratios of ASD to peak capacity of 2 or higher.

CUREE (CUREE, 2001a) and SPD (SEAOSC, 1997) protocols are combined in Table 1-2 because available test data are not sufficient to identify separate parameters for each.

C1.2.3 Vertical Shear Wall Element Performance Expectations. For this group of shear wall sheathing materials, the failure would ideally be the sheathing fastening to framing (or the sheathing material) rather than the boundary members or their connections. This preferred failure would allow development of the sheathing fastening capacity and avoid what might be a more critical failure mode such as sliding or overturning of the wall framing. As a step towards achieving this, the intent of Section 1.4.3 is to have the sheathing peak shear capacity and the capacity of the boundary members and their connections balanced or close to balanced.

For sheathing materials having an ASD to peak strength ratio of approximately 2 from ASD capacity to peak capacity, standard ASD or LRFD detailing practice is thought to provide boundary member connection factors of safety adequate to support failure in the sheathing. Factors of safety of 2.1 to 5 might be anticipated for individual fasteners. Factors of safety of 2.5 to 3 are commonly anticipated for prefabricated connectors. It is anticipated, however, that some connections such as steel straps that are controlled by steel net section might have lower factors of safety.

For sheathing materials having an ASD to peak strength ratio greater than 2, it is recognized that failure could occur in connections of boundary members. At this time, recommendations to design connections to support the higher ratios are viewed as too stringent.

Boundary members (shear wall chords and collector members) are specifically excluded from the detailing list because these members are not viewed as possible weak links given the current range of tabulated unit shears for the sheathing materials. If sheathing members with higher unit shears are to be used, boundary member design should be reconsidered.

REFERENCES

- AC308 Seismic Equivalency Task Group. 2007. "Methodology for Seismic Coefficient Equivalency," presented to ICC ES, July 31, 2007, by Ronald Nelson, Chair, Hermosa Beach, California.
- American Forest & Paper Association. 2005. *Special Design Provisions for Wind and Seismic with Commentary (SDPWS)*. AF&PA, Washington, DC.
- American Iron and Steel Institute. 2007. *North American Standard for Cold-Formed Steel Framing – Lateral Design*, S213-07. AISI, Washington, DC.
- American Society of Civil Engineers. 2005. *Minimum Design Loads for Buildings and Other Structures*, ASCE/SEI 7-05. ASCE, Reston, Virginia.
- Applied Technology Council. 2007. Recommended Methodology for Quantification of Building System Performance and Response Parameters, ATC 63 90 percent draft. ATC, Redwood City, California.
- Boudreault. 2005. "Seismic Analysis of Steel Frame / Wood Panel Shear Walls," M.Eng. Thesis, Department of Civil Engineering and Applied Mechanics, McGill University, Montreal, Quebec, Canada.
- Building Seismic Safety Council. 2003. *NEHRP Recommended Provisions for Seismic Regulations for New Buildings and Other Structures*, FEMA 450. Federal Emergency Management Agency, Washington, DC.

- Consortium of Universities for Research in Earthquake Engineering. 2001a. *Development of a Testing Protocol for Woodframe Structures*, CUREE W-02. CUREE, Richmond, California.
- Consortium of Universities for Research in Earthquake Engineering. 2001b. *Shake Table Tests of a Two-Story Woodframe House*, CUREE W-06. CUREE, Richmond, California.
- Consortium of Universities for Research in Earthquake Engineering. 2004. *Recommendations for Earthquake Resistance in the Design and Construction of Woodframe Buildings*, CUREE W-30. CUREE, Richmond, California.
- Filiatrault, A., H. Isoda, and B. Folz. 2003. "Hysteretic Damping of Wood Framed Buildings," *Engineering Structures*, 25(4): 461-471.
- International Code Council. 2006. *International Building Code (IBC)*, 2006 edition. ICC, Falls Church, Virginia.
- Line, P., N. Waltz, and T. Skaggs. 2008. "Seismic Equivalence Parameters for Engineered Woodframe Wood Structural Panel Shear Walls," *Wood Design Focus*, Summer (Madison, Wisconsin).
- Martin, Z. 2002. *Effect of Green Lumber on Wood Structural Panel Shear Wall Performance*, APA Technical Report T2002-53. APA The Engineered Wood Association, Tacoma, Washington.
- Martin, Z., and T. Skaggs. 2003. *Shear Wall Lumber Framing: Double 2x's vs. Single 3x's at Adjoining Panel Edges*, APA Technical Report T2003-22. APA The Engineered Wood Association, Tacoma, Washington.
- Martin, Z. 2004. *Wood Structural Panel Lateral and Shear Wall Connections with Common, Galvanized Box and Box Nails*, APA Technical Report T2004-14. APA The Engineered Wood Association, Tacoma, Washington.
- Martin, Z., T. Skaggs, and E. Keith. 2005. *Using Narrow Pieces of Wood Structural Panel Sheathing in Wood Shear Walls*, APA Technical Report T2005-08. APA The Engineered Wood Association, Tacoma, Washington.
- Pardoen, G., A. Waltman, R. Kazangy, E. Freund, and C. Hamilton. 2003. *Testing and Analysis of One-Story and Two-Story Shear Walls Under Cyclic Loading*, CUREE Report W-25. Consortium of Universities for Research in Earthquake Engineering, Richmond, California.
- Rosowsky, D., L. Elkins, and C. Carroll. 2004. *Cyclic Tests of Engineered Shear Walls Considering Different Plate Washers*, Report for the American Forest and Paper Association. Oregon State University, Corvallis.
- Structural Engineers Association of Southern California. 1997. *Standard Method of Cyclic (Reversed) Load Test for Shear resistance of Framed Walls for Buildings*, SEAoSC Ad Hoc Committee on Testing Standards for Structural Systems and Components in conjunction with the City of Los Angeles.

Page intentionally left blank.

Resource Paper 12

EVALUATION OF GEOLOGIC HAZARDS AND DETERMINATION OF SEISMIC LATERAL EARTH PRESSURES

Summarized in this resource paper are the procedures commonly used for evaluating potential site geologic hazards and seismic lateral earth pressures due to earthquakes. The geologic hazards include slope instability, liquefaction, ground displacement, and surface fault rupture. Geologic hazards evaluations should be carried out by qualified geotechnical professionals and documented in a report. Reporting requirements are given in Part 1 of the 2009 NEHRP Recommended Seismic Provisions Exception to ASCE/SEI 7-05 (ASCE/SEI 7) Section 11.8. Seismic lateral earth pressure discussions consider both yielding and nonyielding walls.

GEOLOGIC HAZARDS

Screening Evaluation. Evaluation of an earthquake-induced geologic hazard may initially consist of a screening evaluation. Although a screening evaluation typically does not require use of detailed analytical procedures, it should be based on detailed site information including topography, geology, groundwater conditions, subsurface soil and rock stratigraphy and engineering properties, and level of ground shaking. The potential for changes in site conditions over time or as part of site development should be considered. If the findings of a screening evaluation clearly demonstrate the absence of a geologic hazard, then more detailed evaluations, using procedures such as those described in the following sections, need not be conducted. If a screening evaluation does not demonstrate the absence of a hazard, the more comprehensive quantitative evaluations described below should be conducted to assess the potential for slope instability, liquefaction, ground displacement, and surface fault rupture.

The following reference publications provide guidelines on screening evaluations:

1. Slope instability -- Blake et al. (2002), Stewart et al. (2003), U.S. Army Corps of Engineers (2005), and California Geological Survey (2008).
2. Liquefaction -- Martin and Lew (1999) and California Geological Survey (2008). As noted later in this section under "Recent Updates to the SPT Procedure," the "Chinese Criteria" for identifying clayey soils susceptible to liquefaction should be abandoned in favor of more recent research.
3. Total and differential settlement -- Martin and Lew (1999) and California Geological Survey (2008). Total and differential settlement can be important design considerations at sites underlain by poorly compacted fills or loose young alluvium.
4. Surface fault rupture -- California Geological Survey (2002) and U.S. Army Corps of Engineers (2005).

Slope Instability Hazard. When subjected to earthquake-induced ground shaking, sloping ground can pose a hazard to structures located on or in proximity to a slope. The potential severity of the hazard depends on the steepness of the slope, soil and groundwater conditions within the slope, the strength and duration of ground shaking, and the potential consequences of slope movement. In some situations, acceptable slope movement can be on the order of feet whereas in other situations – particularly where buildings are involved – movements of more than a few inches may be unacceptable. A critical first step in the assessment of the slope instability hazard is, therefore, to establish the performance criteria for the slope. Normally this requires detailed discussions between the geotechnical engineer and the structural designer and with the project owner.

Pseudostatic Method of Analysis. The stability of slopes composed of dense (nonliquefiable) or nonsaturated sandy soils or nonsensitive clayey soils can be determined using either pseudostatic- or deformation-based procedures. For initial evaluations, the pseudostatic analysis may be used although the deformational analysis described in the next section is now preferred.

In the pseudostatic analysis, inertial forces generated by earthquake shaking are represented by an equivalent static horizontal force acting on the slope. The seismic coefficient for this analysis is generally taken as proportional to the site peak ground acceleration, a_{max} (see details in Stewart et al., 2003). The vertical component of ground acceleration is normally assumed to be zero during this representation. The factor of safety for a given seismic coefficient can be estimated by using traditional slope stability calculation methods. A factor of safety of less than 1.0 indicates that the slope will yield and slope deformation can be expected, and a deformational analysis should be made using the techniques discussed below.

A common practice when using the pseudostatic method is to define the seismic coefficient used in the stability analysis as a fraction of the peak ground acceleration. The reduction is introduced to account for the transitory nature of the ground motions. Implicit within this approach is that deformation of the slope is acceptable. To limit permanent displacements to less than 2 inches (5 cm), the recommended approach is to use the peak ground acceleration multiplied by f_{eq} , as discussed in Blake et al. (2002) and Stewart et al. (2003), in the pseudostatic analysis and then, if the resulting factor of safety is less than 1.0, to conduct a deformational analysis.

When conducting a pseudostatic stability analysis, two key assessments must be made by the designer during the set-up of the stability model:

1. An accurate characterization of the site must be developed. This characterization needs to consider the final slope geometry, the soil types and layering within the slope, and groundwater conditions likely to exist during the seismic event. The existence of thin soil layers that could serve as slip planes is particularly important in the characterization process.
2. The appropriate soil strength to use for the seismic analyses must be selected. This determination will depend on various factors including whether the soil is fine- or coarse-grained, the effective stress conditions, the degree of saturation of the material, and the stress history for the soil. For saturated materials, in most situations the undrained strength of the soil is appropriate because of the short duration of seismic loading. Blake et al. (2002) provides important guidance on the use of drained or undrained soil properties, the appropriate type of testing, the use of peak versus residual strengths, and whether reductions in strength are appropriate to account for the effects of loading rate and repeated cycles of load.

For sites where soils could liquefy or where sensitive soils are known to occur, special studies will be required. If liquefaction is predicted under the seismic event, the strength of the soil in a liquefied state should be used in the pseudostatic stability analyses. Additional discussions of the strength of liquefied soils are presented below in the liquefaction hazard section of this resource paper. If sensitive clayey soils exist, special laboratory tests may be required to establish the amount of degradation in soil strength that will occur with cyclic loading.

Deformational Methods of Analysis. Deformational analyses resulting in estimates of slope displacement are now accepted practice. The most common analysis, termed a Newmark analysis (Newmark, 1965), uses the concept of a frictional block sliding on a sloping plane or arc. In this analysis, seismic inertial forces are calculated using a history of horizontal acceleration as the input motion. Slope movement occurs when the driving forces (gravitational plus inertial) exceed the resisting forces. This approach estimates the cumulative displacement of the sliding mass by double-integrating increments of relative acceleration that occur during periods of time when the driving forces exceed the resisting forces. Expressed differently, displacement or yield occurs when the earthquake ground accelerations exceed the acceleration required to initiate slope movement or yield acceleration.

The yield acceleration depends primarily on the strength of the soil and the gradient and height and other geometric attributes of the slope. The same comments on the characterization of the slope and soil strength given above for the pseudostatic analysis apply for the deformational analysis; however, consideration can be given to the modification of strength with cycles of earthquake loading. See Figure 1 for forces and equations used in analysis and Figure 2 for a schematic illustration for a calculation of the displacement of a soil block toward a bluff.

Two methods are commonly used to estimate slope displacements by the Newmark method. The more rigorous approach involves use of earthquake records that will be representative of expected ground shaking at the site during a seismic event. These records need to be scaled to be consistent with the response spectra adjusted for site response effects. If more than one characteristic source mechanism contributes to the earthquake hazard, it may be necessary to select sets of records that are characteristic of each source mechanism. In this case, multiple potential sources are considered because of the dependency of slope displacement on earthquake magnitude or duration -- i.e., a large distant earthquake may result in lower peak ground acceleration but longer duration of shaking, which potentially could result in more cumulative deformation than a nearby earthquake of higher peak ground acceleration but short duration. Computer programs (e.g., Jibson and Jibson, 2003) are typically used to determine the cumulative displacement from the earthquake records.

An acceptable alternative method for the determination of displacements on many projects involves the use of charts or simplified equations that show or estimate displacements for different acceleration ratios, where the acceleration ratio is defined as the ratio of yield acceleration to the maximum horizontal equivalent acceleration (MHEA) in the slide mass. These charts and equations have been developed by calculating the cumulative displacement following the Newmark method for large sets of earthquake records. The charts include those by Franklin and Chang (1977), Makdisi and Seed (1978), Wong and Whitman (1982), Hynes and Franklin (1984), Martin and Qiu (1994), Bray and Rathje (1998), Bray et al. (1998), and Jibson (2007). Simple equations include those by Bray and Travarasrou (2007), Jibson (2007), Saygili and Rathje (2008), and Rathje and Saygili. (2008). Figure 3 shows the simplified chart from Bray et al. (1998) that was recommended for use by Blake et al. (2002). The $D_{5.95}$ term in this figure is the significant duration of shaking – with its relationship differing

depending on whether or not the site is within 10 km of the earthquake source. Choosing which charts to use should be made on the basis of the type of slope and the degree of conservatism necessary for the project. It is important to recognize that when using one of the charts, or the Newmark method in general, a number of simplifying assumptions are made regarding the relationship between the MHEA and the peak acceleration at the site as well as other factors. These assumptions may limit the degree of accuracy to which the deformations can be estimated.

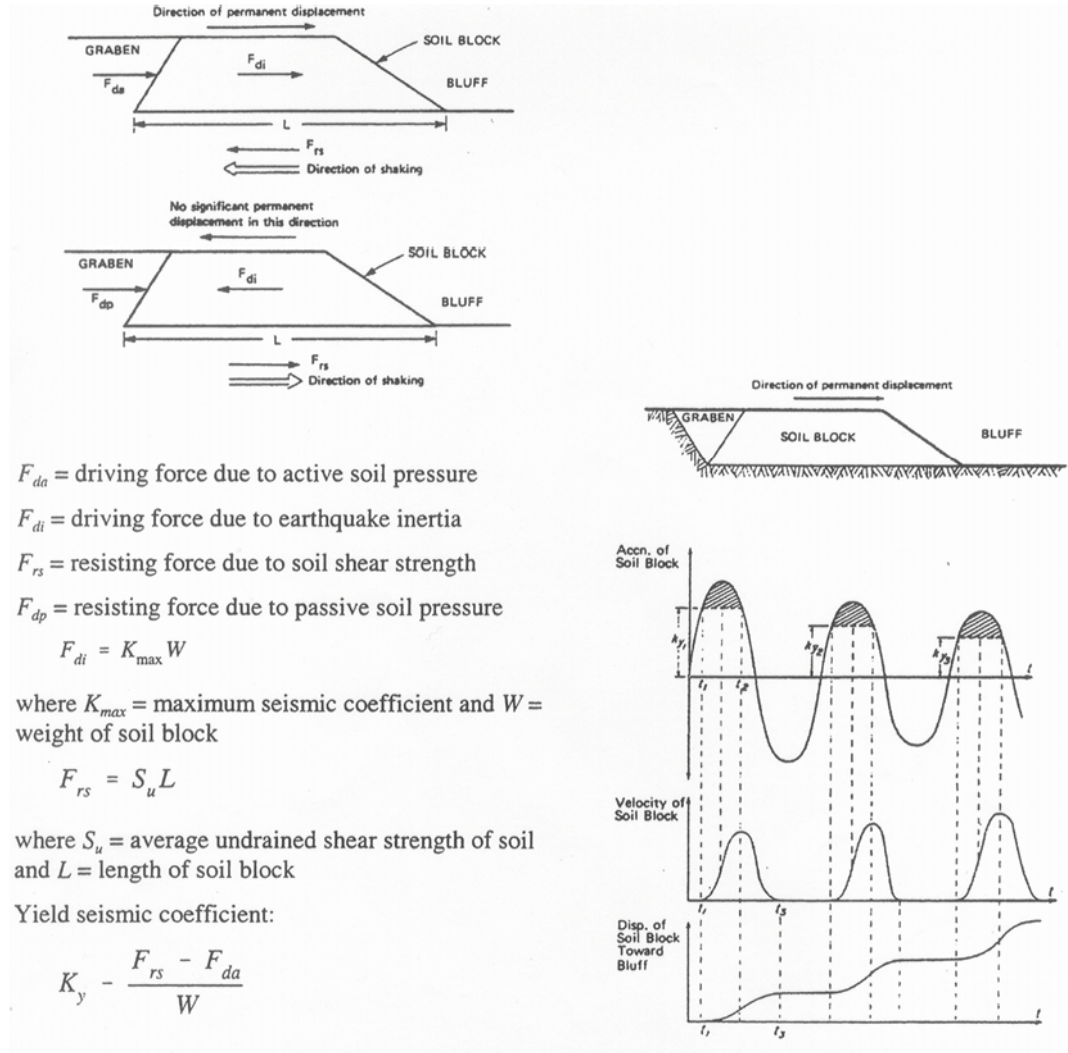

Figure 1 Forces and equations used in analysis of translatory landslides for calculating permanent lateral displacements from earthquake ground motions (National Research Council, 1985; from Idriss, 1985).

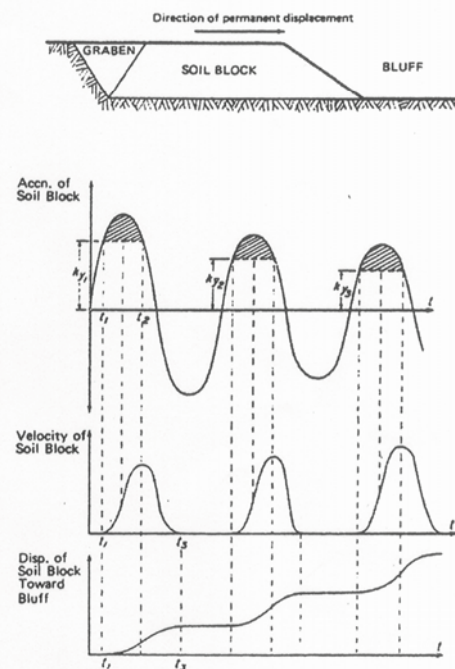

Figure 2 Schematic illustration for calculating displacements of soil block toward the bluff (National Research Council, 1985; from Idriss, 1985, adapted from Goodman and Seed, 1966).

Slope deformations also can be estimated using more rigorous two-dimensional computer modeling methods. FLAC (Itasca, 1997) and PLAXIS (Plaxis, 2008) are programs commonly used by practitioners for evaluating the response of slopes to seismic loads. These computer programs allow various soil geometries, soil layering, and groundwater conditions to be modeled. Earthquake records representative of the seismic event are used to conduct the time-history analysis. Results provide an understanding of the development of deformations with time, the location of critical surfaces of deformation, and the effects of pore water pressure buildup on slope movement. As with any rigorous model, the accuracy of the deformation estimate is critically dependent on the properties and geometry of the model and earthquake record selection.

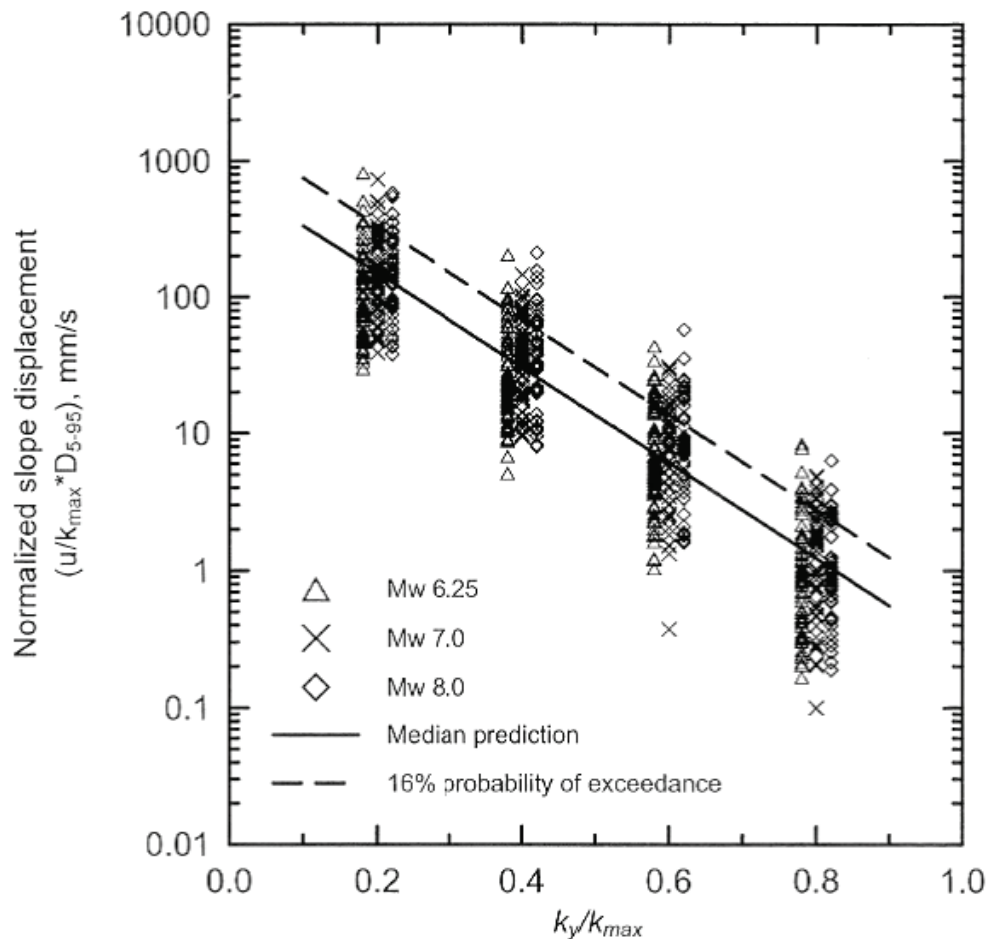

Figure 3 Normalized sliding displacement (Bray et al., 1998) as recommended by Blake et al. (2002).

Mitigation of Slope Instability Hazard. Three general mitigative measures might be considered for locations where slope instability is determined to represent a hazard: (a) design the structure to resist the hazard, (b) stabilize the site to reduce the hazard, or (c) choose an alternative site. Ground displacements generated by slope instability are similar in destructive character to fault displacements generating similar senses of movement: compression, shear, extension or vertical. Thus, the general comments on structural design to prevent damage described in the fault displacement section of this paper apply equally to slope displacement.

Techniques to stabilize a site include increasing the resistance of the soil to displacement by subsurface drainage, buttresses, retaining walls, ground anchors, reaction piles or shafts; ground improvement using densification or soil mixing methods; and chemical treatment. Additional details for these mitigation methods can be found in various reports including Blake et al. (2002).

Liquefaction Hazard. Liquefaction is the second and, perhaps, the most widely known geologic hazard that must be considered at a building site. This hazard occurs when earthquake-induced ground shaking results in loss of strength within water-saturated, loose granular soils. The consequence of this strength loss relative to a building can be reduction in bearing capacity, total and differential settlement, and horizontal ground displacement from lateral spreading or flow failures within the ground. In this section, the hazard of differential settlement, whether due to liquefaction of water-saturated soils or compaction of non-saturated soils, is addressed.

Design to prevent damage due to liquefaction consists of: (a) evaluation of the liquefaction hazard, (b) evaluation of potential ground displacement, and (c) when necessary, mitigation of the hazard by designing to resist either ground displacement or strength loss, by reducing the potential for liquefaction, or by choosing an alternative site with less hazard. Before providing guidance in these areas, the following subsections summarize the methods used to evaluate the liquefaction hazard and recent updates to the most commonly used method of assessing a liquefaction hazard – the empirical standard penetration test procedure.

Methods of Liquefaction Hazard Evaluation. The liquefaction hazard at a site is commonly expressed in terms of a factor of safety. This factor is defined as the ratio between the available liquefaction resistance, expressed in terms of the cyclic stresses required to cause liquefaction, and the cyclic stresses generated by the earthquake. Both of these stress parameters are commonly normalized with respect to the effective overburden stress at the depth in question to define a cyclic resistance ratio (CRR) and a cyclic stress ratio induced by the earthquake (CSR).

Three different methods have been proposed and are used to various extents for evaluating liquefaction potential:

1. Empirical methods are the most widely used methods in practice. These procedures rely on correlations between observed cases of liquefaction/non-liquefaction and measurements made in the field with conventional exploration methods. Seed and Idriss (1971) first published the widely used “simplified procedure” utilizing the standard penetration test (SPT). Since then, field test methods in addition to the SPT have been utilized in similar simplified procedures. These methods include cone penetrometer tests (CPTs), Becker hammer tests (BHTs), and shear wave velocity tests (SVTs). These empirical procedures are summarized in the proceedings from a workshop (referred to as the Liquefaction Workshop) held in 1996 (NCEER, 1997; Youd et al., 2001). Martin and Lew (1999) provides additional details on the use of these procedures relative to engineering practice; Idriss and Boulanger (2008) summarize recent developments in use of empirical methods for assessing liquefaction potential in a recently published EERI Monograph *Soil Liquefaction during Earthquakes*. The Idriss and Boulanger (2008) EERI Monograph updates an earlier EERI Monograph by Seed and Idriss (1982).
2. Analytical methods are used less frequently to evaluate liquefaction potential; however, they may be required for special projects or where soil conditions are not amenable to the empirical method. Analytical methods also are likely to continue to gain prominence with time as numerical methods and soil models improve and are increasingly validated. The analytical method originally (circa 1970s) involved determination of the induced shearing stresses with a program such as SHAKE and comparison of these stresses to results of cyclic triaxial or cyclic simple shear tests. Today, the analytical method usually refers to a computer program that incorporates a soil model that calculates the buildup in pore water pressure. These more rigorous numerical methods include one-dimensional nonlinear effective stress codes such as DESRA, DMOD, SUMDES, and TESS and two-dimensional nonlinear effective stress codes such as FLAC, TARA, and DYNFLOW. This new generation of analytical methods features soil models that are fitted to or derived from laboratory data or from liquefaction curves developed from SPTs or other field information. These methods are limited by the ability to represent the soil model from either the laboratory or field measurements and by the complexity of the wave propagation mechanisms, including the ability to select appropriate earthquake records to use in the analyses.
3. Physical modeling originally involved the use of centrifuges or relatively small-scale shaking tables to simulate seismic loading under well-defined boundary conditions. Physical model testing also now includes large laminar boxes mounted on very large shake tables (e.g., Kagawa et al., 2004) and full-scale field blast loading tests (e.g., Ashford et al., 2004 and Ashford et al., 2006). This type of modeling is one of the main focus areas of the 2004-2014 Network for Earthquake Engineering Simulation (NEES) supported by the National Science Foundation. Soil used in the small-scale and laminar box models is reconstituted to represent different density and geometrical conditions. Because of difficulties in precisely modeling in situ conditions at liquefiable sites, small-scale and laminar box models have seldom been used in design studies for specific sites. However, physical models are valuable for analyzing and understanding generalized soil behavior and for evaluating the validity of constitutive models under well-defined boundary conditions. Blast loading tests have been conducted to capture the in situ characteristics of the soil for research and design purposes (e.g., at Treasure Island, California; for the Cooper River Bridge in South Carolina, and in Japan). However, the cost and safety issues of blasting methods limit their use to only special design or research projects.

Most liquefaction hazards assessments for buildings involve use of the SPT empirical method -- partly because of the wide acceptance of this method and also because it can be easily integrated into the geotechnical investigations normally performed during building design. The SPT method is based on recommendations developed at the Liquefaction Workshop as described in NCEER (1997) and Youd et al. (2001) or on one of the updates to this methodology as discussed below.

Although the SPT empirical method is the most commonly used of the empirical approaches, it is important to recognize that for certain site conditions alternate empirical methods, such as the CPT, BHT, and SVT methods, are acceptable and even preferred. This is particularly the case with the CPT method. Advantages of the CPT method compared to the SPT method are the ability of this method to detect thin liquefiable layers that could serve as sliding surfaces and the greater standardization of the method; however, the CPT approach has the disadvantage that soil samples are not obtained. When possible, a combination of procedures is recommended to take advantage of the best features of each.

Recent Updates to the SPT and CPT Procedures. The methods presented in the Liquefaction Workshop and summarized in the following section represent a consensus-based approach for determining the onset or triggering of liquefaction; however,

the consensus workshop occurred over 10 years ago. A number of significant modifications to the methods presented in the Liquefaction Workshop have been recommended over the past 10 years. These modifications include:

1. Changes to the stress reduction coefficient (r_d),
2. Modifications to the magnitude scaling factor (MSF) which also is referred to as the duration weighting factor (DWF),
3. Revisions to the overburden correction term for CRR (K_σ) and the fines correction term (FC),
4. Refinements to the overburden correction for penetration resistance (C_N), and
5. Changes to the relationship between cyclic stress ratio causing liquefaction and the normalized penetration resistance (i.e., the fundamental liquefaction strength curve such as shown in Figure 4).

These modifications are discussed in detail in papers by Cetin et al. (2004), Idriss and Boulanger (2004, 2006, 2008), and Moss et al. (2006); each set of recommended revisions resulted after detailed study and supplementation of the databases of case histories upon which the original relationships were developed.

Another important observation during the past 10 years involves the fines criteria used to judge whether or not a soil is liquefiable. Originally, the “Chinese Criteria” was accepted as the method to determine whether or not a cohesionless soil was liquefiable. However, recent work summarized in Boulanger and Idriss (2006), Bray and Sancio (2006), and Idriss and Boulanger (2008) indicates that the Chinese Criteria will be unconservative in some situations, and alternate methods of assessing whether a soil with cohesive fines will be susceptible to liquefaction or cyclic strength reduction need to be considered. The methods recommended by Boulanger and Idriss (2006) and Bray and Sancio (2006) also establish whether the simplified empirical field methods described previously should be used to estimate liquefaction potential or whether other methods, such as laboratory testing, would be more suitable for evaluating the effects of cyclic loading on soil strength.

Methods are also now available for treating the probability of liquefaction, given a certain ground motion and SPT blowcount. Cetin et al. (2004) and Moss et al. (2006) present a comprehensive treatment of liquefaction probability. These researchers suggest that following the deterministic approach for estimating liquefaction potential discussed above results in approximately 15 percent probability of liquefaction. The approach presented by Cetin et al. (2004) allows limiting SPT blowcounts to be determined for alternate probabilities and the probability associated with a given set of blowcounts and ground motions (in terms of CSR) to be defined. Kramer and Mayfield (2007) show how the probability of ground shaking can be combined with the probability of liquefaction in a performance-based approach to evaluating liquefaction potential. This probabilistic framework forms an important basis for the performance-based design methods currently being developed.

Despite these many important modifications to the general approach for assessing liquefaction hazards over the past 10 years, the profession has not developed a consensus on which of the modifications should be used as a baseline for evaluating liquefaction hazard – similar to the recommendations in NCEER (1997) and Youd et al. (2001) based on the Liquefaction Workshop. Procedures suggested by Idriss and Boulanger (2004, 2006, 2008) and those developed by Cetin et al. (2004) and Moss et al. (2006) present important changes to the liquefaction hazard analysis. However, until a consensus is reached or an adequate period of vetting occurs, it is difficult to recommend which of these procedures should be used.

It is important that the newer methods be used consistently. In other words, the Idriss and Boulanger method should be used with the various improvements recommended by Idriss and Boulanger including the revised liquefaction strength plot. Likewise, if the Cetin et al. method is going to be used, it should be used in its entirety. It also is important to use these new methods with some caution, particularly at the limits of the procedure (e.g., at higher blowcounts, deeper depths, and higher CSR values). If the more recent methods are used, the prudent approach will be to check the liquefaction hazard with an alternate method, such as the SPT procedure discussed below. Differences between the hazard estimates resulting from different methods could reflect a real uncertainty in the prediction, and this uncertainty would need to be considered when judging the hazard at a site.

Empirical SPT Method for Evaluating Liquefaction Hazard. Procedures for evaluating the liquefaction hazard using the Liquefaction Workshop methodology are summarized below. As discussed above, the recent changes in the methodology proposed by Idriss and Boulanger (2004, 2006, 2008), Cetin et al. (2004), and Moss et al. (2006) offer alternatives to this approach.

1. The first step in the liquefaction hazard evaluation using the empirical SPT approach is to define the normalized cyclic shear stress ratio (CSR) from the peak horizontal ground acceleration expected at the site. This evaluation is made using the following equation:

$$CSR = 0.65(a_{\max}/g)(\sigma_0/\sigma'_0)r_d \quad (1)$$

where (a_{max}/g) is the peak horizontal acceleration at ground surface expressed as a decimal fraction of gravity, σ_0 is the vertical total stress in the soil at the depth in question, σ'_0 is the vertical effective stress at the same depth, and r_d is the deformation-related stress reduction factor. The peak ground acceleration, a_{max} , commonly used in liquefaction analysis is that which would occur at the site in the absence of liquefaction. Thus, the a_{max} used in Eq. 1 is the estimated rock acceleration corrected for soil site response but with neglect of excess pore-water pressures that might develop.

The stress reduction factor, r_d , used in Eq. 1 was originally determined using a plot developed by Seed and Idriss (1971) showing the reduction factor versus depth. The consensus from the Liquefaction Workshop was to represent r_d by the following equations:

$$\text{For } z \leq 9.15 \text{ m, } r_d = 1.0 - 0.00765z \quad (2a)$$

$$\text{For } 9.15 \text{ m} < z \leq 23 \text{ m, } r_d = 1.174 - 0.267z \quad (2b)$$

- The second step in the liquefaction hazard evaluation using the empirical approach involves determination of the normalized cyclic resistance ratio (CRR). The most commonly used empirical relationship compares CRR with corrected SPT resistance, $(N_1)_{60}$, from sites where liquefaction did or did not develop during past earthquakes. Figure 4 shows this relationship for magnitude 7.5 earthquakes with an adjustment at low values of CRR recommended by the Liquefaction Workshop. Similar relationships have been developed for determining CRR from CPT soundings, from BHT blowcounts, and from shear wave velocity data as discussed by Youd et al. (2001) and as presented in detail in NCEER (1997).

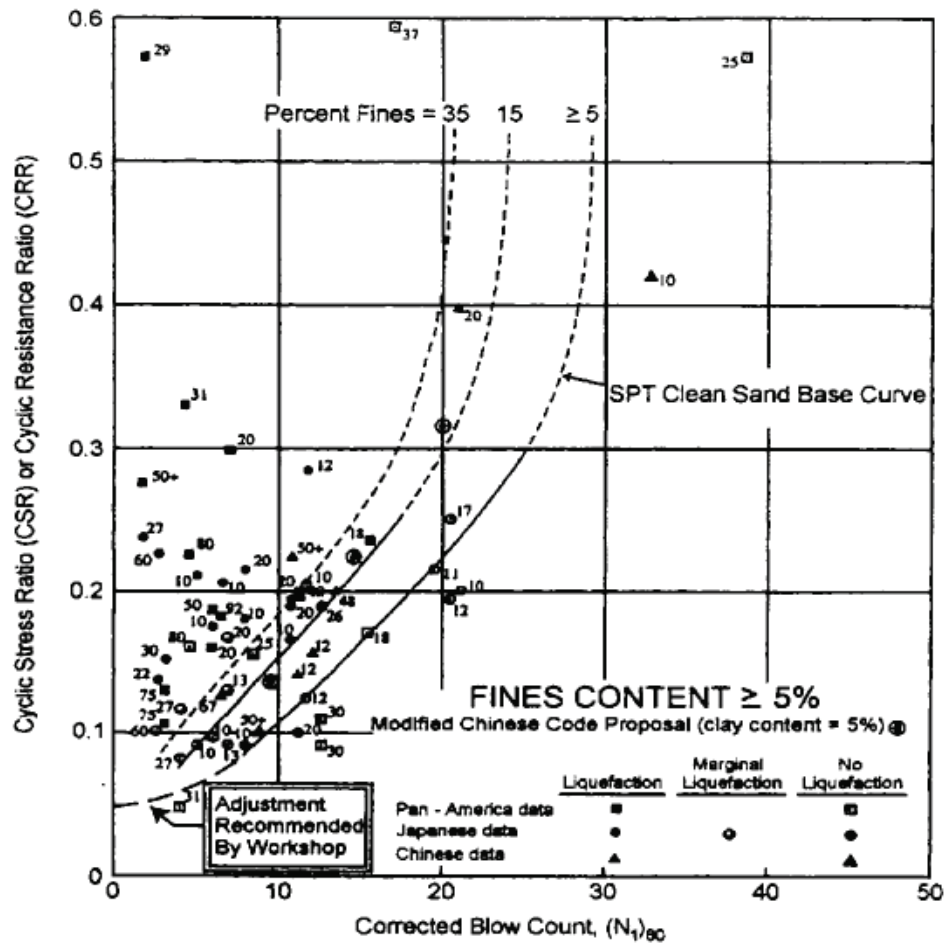

Figure 4 SPT clean sand base curve for magnitude 7.5 earthquakes with data from liquefaction case histories (modified from Seed et al., 1985, to reflect NCEER, 1997, and Youd et al., 2001).

It should be noted that nearly all the field data used to develop the simplified procedure are for depths less than 50 feet; therefore, there is greater uncertainty in the use of empirical approaches at greater depths. Common practice is to use the

SPT or CPT method to depths of 75 feet. In some locations, deep deposits of low blowcount or low CPT end resistance values occur (e.g., in the Puget Sound area and along the Columbia River). It is still prudent to consider these low blowcount materials as susceptible to liquefaction even if they are located at depths greater than 75 feet. For these sites, it is important to correct the CRR with an overburden correction factor (K_{σ}). Alternatively, it may be appropriate to use strain-based procedures (Dobry et al., 1982) or one-dimensional effective stress modeling methods.

In Figure 4, CRRs calculated for various sites are plotted against $(N_1)_{60}$, where $(N_1)_{60}$ is the SPT blowcount normalized for an overburden stress of 100 kPa and for an energy ratio of 60 percent. Solid symbols represent sites where liquefaction occurred and open symbols represent sites where surface evidence of liquefaction was not found. Curves were drawn through the data to separate regions where liquefaction did and did not develop. As shown, curves are given for soils with fines contents (FC) ranging from less than 5 to 35 percent.

The $(N_1)_{60}$ in Figure 4 is adjusted for various factors before its use as recommended by the Liquefaction Workshop and discussed by Youd et al. (2001). These include an adjustment for fines, such that only the clean sand curve in Figure 4 is used, as well as adjustments for a number of other testing related parameters, including whether or not liners are used in the SPT sampler and the energy calibration factor. These adjustments are all in conventional use by the profession and can readily be found in references by Martin and Lew (1999) and by Youd et al. (2001).

It is very important that the engineer consider these correction factors when conducting the liquefaction analyses. Failure to consider these corrections can result in inaccurate liquefaction estimates -- leading to either excessive cost to mitigate the liquefaction concern or excessive risk of poor performance during a seismic event – potentially resulting in unacceptable damage.

Special mention needs to be made of the energy calibration term, C_E . This correction has a very significant effect on the $(N_1)_{60}$ used to compute CRR. The value of this correction factor can vary greatly depending on the SPT hammer system used in the field and on site conditions. The automatic hammer now used to conduct SPTs avoids much of the uncertainty in energy; however, even it should be periodically calibrated. These calibration measurements are relatively inexpensive and represent a small increase in overall field exploration costs. Many drilling contractors in areas that are seismically active provide calibrated equipment as part of their routine service.

Before computing the factor of safety from liquefaction, the CRR result obtained from Figure 4, using the corrected SPT blow count identified in the equation for $(N_1)_{60}$, must be corrected for earthquake magnitude M if the magnitude differs from 7.5. The magnitude correction factor is shown in Figure 5. This plot was developed during the Liquefaction Workshop on the basis of input from experts attending the workshop. The range shown in Figure 5 is used because of uncertainties. Research conducted since the Liquefaction Workshop has shown that magnitude scaling factors near the lower limit of the recommended range are appropriate for $M < 7.5$ (Liu et al., 2001; Cetin et al., 2004; Boulanger and Idriss, 2006).

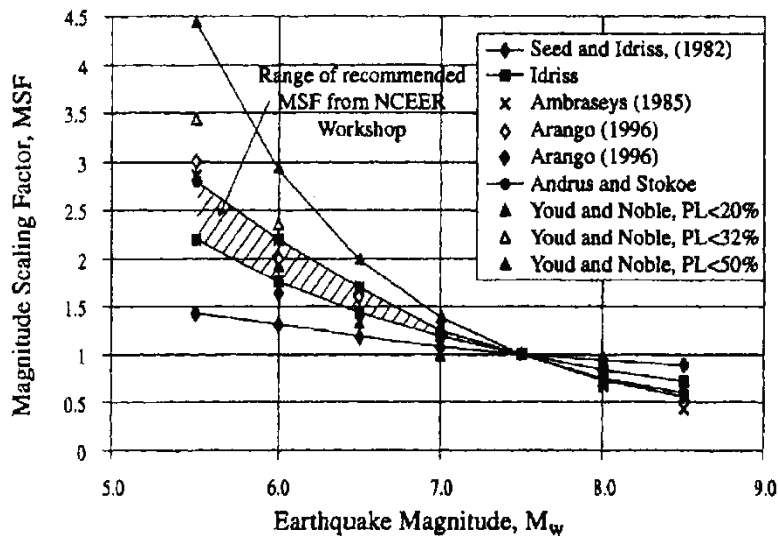

Figure 5 Magnitude scaling factors derived by various investigators (NCEER, 1997; Youd et al., 2001).

The magnitude, M , needed to determine a magnitude scaling factor from Figure 5 should be consistent with the hazard level used in the ground motion determination. When the general procedure for ground motion estimation is used (ASCE/SEI 7 Sections 11.4.1 to 11.4-6) and the MCE (per ASCE/SEI 7) is determined probabilistically, the magnitude

used in these evaluations can be obtained as the dominant magnitude(s) determined from deaggregation information available by latitude and longitude from a U.S. Geological Survey (USGS) website: <http://earthquake.usgs.gov/research/hazmaps/>. When the general procedure is used and the MCE is bounded deterministically near known active fault sources, the magnitude of the MCE should be the characteristic maximum magnitude assigned to the fault in the construction of the MCE ground motion maps. Where the site-specific procedure for ground motion estimation is used (ASCE/SEI 7 Sections 11.4.7 and Chapter 21), the magnitude of the MCE should be similarly determined from the site-specific analysis. In all cases, it should be remembered that the likelihood of liquefaction at the site (as defined later by the factor of safety F_L in Eq. 3) is determined jointly by a_{max} and M and not by a_{max} alone. Because of the longer duration of strong ground-shaking, large distant earthquakes may in some cases generate liquefaction at a site while smaller nearby earthquakes may not generate liquefaction even though a_{max} of the nearer events is larger than that from the more distant events.

A more recent procedure developed by Kramer and Mayfield (2007) estimates the return period for liquefaction directly without the use of the magnitude scaling factors. This approach considers both the peak acceleration hazard curve and the distribution of earthquakes contributing to the ground motion hazard.

3. The final step in the liquefaction hazard evaluation using the empirical approach involves the computation of the factor of safety (F_L) against liquefaction using the equation:

$$F_L = CRR/CSR \quad (3)$$

If F_L is greater than 1.0, then liquefaction should not develop. If at any depth in the sediment profile, F_L is equal to or less than 1.0, then there is a liquefaction hazard. Although the curves shown in Figure 4 envelop the plotted data, it is possible that liquefaction may have occurred beyond the enveloped data and was not detected at the ground surface. For this reason, a factor of safety of 1.1 to 1.3 is usually appropriate for building sites -- with the actual factor selected on the basis of the importance of the structure and the potential for ground displacement at the site.

Additional guidance on the selection of the appropriate factor of safety is provided by Martin and Lew (1999). They suggest that the following factors be considered when selecting the factor of safety:

1. The type of structure and its vulnerability to damage.
2. Levels of risk accepted by the owner or governmental regulations with questions related to design for life safety, limited structural damage, or essentially no damage.
3. Damage potential associated with the particular liquefaction hazard. Flow failures or major lateral spreads pose more damage potential than differential settlement. Hence factors of safety could be adjusted accordingly.
4. Damage potential associated with the earthquake magnitude. A magnitude 7.5 event is potentially more damaging than a 6.5 event.
5. Damage potential associated with SPT values; low blowcounts have a greater cyclic strain potential than higher blowcounts.
6. Uncertainty in SPT- or CPT-derived liquefaction strengths used for evaluations. Note that a change in silt content from 5 to 15 percent could change a factor of safety from, say, 1.0 to 1.25.
7. For high levels of ground motion, factors of safety may be indeterminate. For example, if $(N_f)_{60cs} = 20$, $M = 7.5$ and fines content = 35 percent, liquefaction strengths cannot be accurately defined due to the vertical asymptote on the empirical strength curve.

Martin and Lew (1999) indicate that the final choice of an appropriate factor of safety must reflect the particular conditions associated with the specific site and the vulnerability of site-related structures. Table 1 summarizes factors of safety suggested by Martin and Lew.

As a final comment on the assessment of liquefaction hazards, it is important to note that soils composed of sands, silts, and gravels are most susceptible to liquefaction while clay soils generally are not susceptible to this phenomenon. The curves in Figure 4 are valid for soils composed primarily of sand. The curves should be used with caution for soils with substantial amounts of gravel. Verified corrections for gravel content have not been developed; a geotechnical engineer, experienced in liquefaction hazard evaluation, should be consulted when gravelly soils are encountered.

Evaluation of Potential for Loss of Ground Support, Increased Loads, and Ground Displacements. Liquefaction by itself may or may not be of engineering significance. Only when liquefaction is accompanied by loss of ground support, increased soil loads, and/or ground deformation does this phenomenon become important to structural design. Surface manifestations, loss of bearing capacity, increased lateral earth pressures, ground settlement, flow failure, and lateral spread are ground failure mechanisms that have caused structural damage during past earthquakes. These types of ground failure are described

in National Research Council (1985), Martin and Lew (1999), and U.S. Army Corps of Engineers (2005) and are discussed below. The type of failure and amount of ground displacement are a function of several parameters including the looseness of the liquefied soil layer, the thickness and extent of the liquefied layer, the thickness and permeability of unliquefied material overlying the liquefied layer, the ground slope, and the nearness of a free face.

Table 1 Factors of Safety for Liquefaction Hazard Assessment (from Martin and Lew, 1999)

Consequences of Liquefaction	$(N_f)_{60cs}$	Factor of Safety
Settlement	< 15	1.1
	> 30	1.0
Surface manifestations	< 15	1.2
	> 30	1.0
Lateral spread	< 15	1.3
	> 30	1.0

Evaluation of Potential for Loss of Ground Support, Increased Loads, and Ground Displacements. Liquefaction by itself may or may not be of engineering significance. Only when liquefaction is accompanied by loss of ground support, increased soil loads, and/or ground deformation does this phenomenon become important to structural design. Surface manifestations, loss of bearing capacity, increased lateral earth pressures, ground settlement, flow failure, and lateral spread are ground failure mechanisms that have caused structural damage during past earthquakes. These types of ground failure are described in National Research Council (1985), Martin and Lew (1999), and U.S. Army Corps of Engineers (2005) and are discussed below. The type of failure and amount of ground displacement are a function of several parameters including the looseness of the liquefied soil layer, the thickness and extent of the liquefied layer, the thickness and permeability of unliquefied material overlying the liquefied layer, the ground slope, and the nearness of a free face.

Surface manifestations refer to sand boils and ground fissures on level ground sites. For structures supported on shallow foundations, the effects of surface manifestations on the structure could be tilting or cracking. Criteria are given by Ishihara (1985) and Youd and Garris (1995) for evaluating the influence of thickness of layers on surface manifestation of liquefaction effects for level sites. These criteria may be used for noncritical or nonessential structures on level sites not subject to lateral spreads (see later in this section). Differential settlements associated with these surface manifestations may also require consideration.

Loss of bearing capacity can occur if the foundation is located within or above the liquefiable layer. The consequence of bearing failure could be settlement or tilting of the structure. Usually, loss of bearing capacity is not likely for light structures with shallow footings founded on stable, nonliquefiable materials overlying deeply buried liquefiable layers, particularly if the liquefiable layers are relatively thin. Simple guidance for how deep or how thin the layers must be has not yet been developed. Martin and Lew (1999) provide some preliminary guidance based on the Ishihara (1985) method. Final evaluation of the potential for loss of bearing should be made by a geotechnical engineer experienced in liquefaction hazard assessment.

Another possible consequence of liquefaction is increased lateral pressures against basement and retaining walls. The liquefied material will have an at-rest earth pressure coefficient (K_0) between 1.0 and the K_0 value for the non-liquefied soil, depending on the strength of the liquefied soil. A common approach is to conservatively assume that the liquefied soil is a dense fluid having a unit weight of the liquefied soil. The wall then is designed assuming that hydrostatic pressure for the dense fluid acts against the wall. If unsaturated soil is present above the liquefied soil, it is treated as a surcharge that increases the fluid pressure within the underlying liquefied soil by an amount equal to the thickness times the total unit weight of the surcharge soil. This procedure applies equivalent horizontal earth pressures that are greater than typical at-rest earth pressures but less than passive earth pressures.

To prevent buoyant rise of a structure as a consequence of liquefaction, the total weight of the structure should be greater than the volume of the basement or other cavity times the unit weight of liquefied soil. Structures with insufficient weight to counterbalance buoyant effects could differentially rise during an earthquake.

For saturated or dry granular soils in a loose condition, the amount of ground settlement can approach 3 to 4 percent of the thickness of the loose soil layer in some cases. This amount of settlement could cause tilting or cracking of a building, and therefore, it is usually important to evaluate the potential for ground settlement during earthquakes.

Tokimatsu and Seed (1987) published an empirical procedure for estimating ground settlement. It is beyond the scope of this discussion to outline that procedure which, although explicit, has several rather complex steps. The Tokimatsu and Seed

procedure can be applied whether liquefaction does or does not occur. For dry cohesionless soils, the settlement estimate from Tokimatsu and Seed should be multiplied by a factor of 2 to account for multi-directional shaking effects as discussed by Martin and Lew (1999). Duku et al. (2008) present updated relationships for the calculation of settlement of unsaturated clean sands. An alternate approach for settlement of liquefiable soils is that proposed by Ishihara and Yoshimine (1992).

Earthquake-induced ground settlement usually will not occur uniformly at a site. Differences in soil layering and soil consistency will lead to differential settlement. The amount of differential settlement can be estimated if sufficient geotechnical information is available for a site. If such information is not available, a common approach is often to assume that differential settlement will range from 0.5 to 0.75 times the total settlement obtained from one of the above predictive methods.

Flow failures or flow slides are the most catastrophic form of ground failure that may be triggered when liquefaction occurs. They may displace large masses of soils tens of feet. Flow slides occur when the average static shearing stresses on potential failure surfaces are less than the average shear strengths of liquefied soil on these surfaces. Standard limit equilibrium static slope stability analyses may be used to assess flow failure potential with the residual strength of liquefied soil used as the strength parameter in the analyses.

The determination of residual strengths is very inexact, and consensus as to the most appropriate approach has not been reached to date. Relationships for residual strength of liquefied soil that are often used in practice are those of Seed and Harder (1990), Olson and Stark (2002), and Idriss and Boulanger (2007). These strengths have been empirically determined from forensic analyses of flow failures.

Lateral spreads are ground-failure phenomena that can occur on gently sloping ground underlain by liquefied soil. They may result in lateral movements in the range of a few inches to several feet. Earthquake ground-shaking affects the stability of gently sloping ground containing liquefiable materials by seismic inertial forces combined with static gravity forces within the slope and by shaking-induced strength reductions in the liquefiable materials. Temporary instability due to seismic inertial forces is manifested by lateral “downslope” movement. For the duration of ground shaking associated with moderate- to large-magnitude earthquakes, there could be many such occurrences of temporary instability during earthquake shaking producing an accumulation of “downslope” movement.

Various analytical and empirical techniques have been developed to estimate lateral spread ground displacement; however, no single technique has been widely accepted for engineering design. Three approaches are used depending on the requirements of the project: Empirical procedures, simplified analytical methods, and more rigorous computer modeling use correlations between past ground displacement and site conditions under which those displacements occurred. Youd et al. (2002) presents an empirical method that provides an estimate of lateral spread displacements as a function of earthquake magnitude, distance, topographic conditions, and soil deposit characteristics. As shown in Figure 6, the displacements estimated by the Youd et al. (2002) method are generally within a factor of two of the observed displacements.

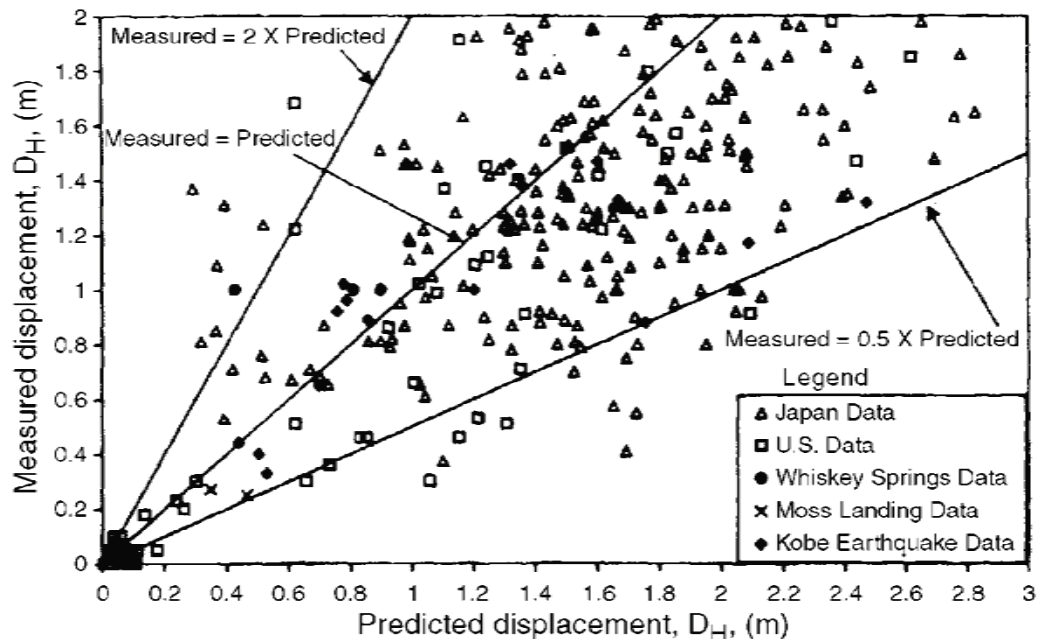

Figure 6 Measured versus predicted displacements for displacements up to 2 meters (Youd et al., 2002).

Bardet et al. (2002) presents an empirical method having a formulation similar to that of Youd et al. (2002) but using fewer parameters to describe the soil deposit. The Bardet et al. (2002) model was developed to assess lateral spread displacements at a regional scale rather than for site-specific applications. Various other empirical methods are also available, including an alternate SPT method by Rausch and Martin (2000) and both SPT- and CPT-based methods by Zhang et al. (2004). These methods can result in large differences in predicted displacement; therefore, it is usually best to use several methods when estimating displacement. Because of the uncertainty in results, these methods normally are used for preliminary screening or comparative evaluations.

Simplified analytical techniques generally apply some form of Newmark's analysis of a rigid body sliding on an infinite or circular failure surface with ultimate shear resistance estimated from the strength of the liquefied soil. Additional discussion of the simplified Newmark method is provided in the discussion of slope instability hazard. A key question for this approach is the method of defining the strength of the liquefied soil. The same residual strength as used for flow failure assessments often has been used for the spreading analyses. However, many researchers will argue that lateral spreads do not involve the same boundary conditions as occur for lateral flows and, specifically, that the ratcheting mechanism of loading with dilation at larger strains is not properly considered. No consensus currently exists on the most suitable method for obtaining the liquefied strength for lateral spreading analyses; however, the use of the residual strength from flow failures is thought to be conservative for most lateral spreading analyses. Work by Olson and Johnson (2008) appear to support the acceptability of use of the residual strength. In view of the current uncertainties, a cautious approach must be taken when estimating deformations for cases involving liquefaction.

More rigorous computer modeling typically involves use of nonlinear finite element or finite difference methods to predict deformations (e.g., using the FLAC and PLAXIS software). As noted previously, the accuracy of this approach is critically dependent on the properties and geometry of the model as well as the earthquake record selection. Of particular importance for the liquefaction problem is the completeness of the pore pressure model and its ability to handle various soil conditions. For example, the soil model within the nonlinear computer analysis programs often is calibrated for only specific conditions. If the site is not characterized by these conditions, errors in estimating the displacement by a factor of two or more can easily occur.

Mitigation of Liquefaction Hazard. Three general measures might be considered for mitigation of liquefaction hazards: (a) design the structure to resist the hazard, (b) stabilize the site to reduce the hazard, or (c) choose an alternative site.

Structural measures that are used to reduce the hazard include deep foundations, mat foundations, or footings interconnected with ties:

1. Deep foundations have performed well at level sites where liquefaction effects were limited to ground settlement and ground oscillation with no more than a few inches of lateral displacement. Deep foundations, such as piles, must consider the potential for reduced soil support through the liquefied layer and may be subjected to lateral displacements across the layer. Loss in lateral support may require ground improvement around the deep foundations or strengthening of the pile. Downdrag forces resulting from post-seismic soil settlement must also be considered. Downdrag forces can result in pile settlement after the earthquake as liquefied soils settle relative to the pile. These downdrag forces result in added structure load and potentially pile settlement, depending on the strength of the soil below the deepest depth of liquefaction. Mitigation procedures for downdrag can include use of bitumen coatings or sleeves that isolate the pile from downdrag forces.
2. Well reinforced mat foundations also have performed well at localities where ground displacements were less than 1 foot, although releveling of the structure was required in some instances (Youd, 1989). Strong ties between footings also should provide increased resistance to damage where differential ground displacements are less than 1 foot.

Evaluations of structural performance following two Japanese earthquakes, 1993 Hokkaido Nansei-Oki and 1995 (Kobe) Hyogo-Ken Nanbu, indicate that small structures on shallow foundations performed well in liquefaction areas where ground displacements were small. Sand boil eruptions and open ground fissures in these areas indicate minor effects of liquefaction including ground oscillation and up to 1 foot of lateral spread displacement. Many small structures (mostly houses, shops, schools, etc.) were structurally undamaged although a few tilted slightly. Foundations for these structures consist of reinforced concrete perimeter wall footings with reinforced concrete interior wall footings tied into the perimeter walls at intersections. These foundations acted as diaphragms causing the soil to yield beneath the foundation which prevented fracture of foundations and propagation of differential displacements into the superstructure.

At sites where expected ground displacements are unacceptably large or where excessive strength loss beneath a foundation needs to be mitigated, ground modification to lessen the liquefaction or ground failure hazard may be required. Techniques for ground stabilization to prevent liquefaction of potentially unstable soils include removal and replacement of soil; compaction of soil in place using vibrations, heavy tamping, compaction piles, or compaction grouting; buttressing; chemical

stabilization with grout; and installation of drains. Further discussion of mitigation methods is given by the National Research Council (1985) and Martin and Lew (1999).

In some situations the structure cannot be strengthened and ground improvement is not practical or possible. For these locations selection of an alternative site may be required.

Surface Fault Rupture Hazard. Fault ruptures during past earthquakes have led to large surface displacements that are potentially destructive to engineered construction. Displacements, which range from a fraction of an inch to tens of feet, may occur along traces of active faults. The sense of displacement ranges from horizontal strike-slip to vertical dip-slip to many combinations of these components. The following paragraphs summarize procedures to consider when assessing the hazard of surface fault rupture. Sources of detailed information for evaluating the hazard of surface fault rupture include Slemmons and dePolo (1986), the Utah Section of the Association of Engineering Geologists (1987), Swan et al. (1991), Hart and Bryant (1997), Hanson et al. (1999), and California Geological Survey (2002). Other beneficial references are given in the bibliographies of these publications.

Assessment of Surface Faulting Hazard. The evaluation of surface fault rupture hazard at a given site is based extensively on the concepts of recency and recurrence of faulting along existing faults. The magnitude, sense, and frequency of fault rupture vary for different faults or even along different segments of the same fault. Even so, future faulting generally is expected to recur along pre-existing active faults. The development of a new fault or reactivation of a long inactive fault is relatively uncommon and generally need not be a concern. For most engineering applications related to foundation design, a sufficient definition of an active fault is given in CDMG Special Publication 42 (Hart and Bryant, 1997): “An active fault has had displacement in Holocene time (about the last 11,000 years).”

As a practical matter, fault investigations should be conducted by qualified geologists and directed at the problem of locating faults and evaluating recency of activity, fault length, the amount and character of past displacements, and the expected amount and potential of future displacement. Identification and characterization studies should incorporate evaluation of regional fault patterns as well as detailed study of fault features at and in the near vicinity (within a few hundred yards to a mile) of the site. Detailed studies can include trenching to accurately locate, document, and date fault features.

The following approach should be considered in fault hazard assessment, and some of the investigative methods outlined should be carried out beyond the site being investigated:

1. A review should be made of the published and unpublished geologic literature about the region along with records concerning geologic units, faults, ground-water barriers, etc.
2. A stereoscopic study of aerial photographs and other remotely sensed images should be made to detect fault-related topography/geomorphic features, vegetation and soil contrasts, and other lineaments of possible fault origin. The study of predevelopment aerial photographs often is essential to the detection of fault features. Recently, the use of LiDAR (LIght Detection And Ranging) has been found to provide excellent identification of fault traces in areas where tree growth and vegetation normally would obscure evidence of faulting from the air.
3. A field reconnaissance study generally is required and should include observation and mapping of features such as bedrock and soil units and structures, geomorphic surfaces, fault-related geomorphic features, springs, and deformation of man-made structures due to fault creep. Field study should be detailed within the site with less detailed reconnaissance of an area within a mile or so of the site. Evidence from prehistoric liquefaction (paleoliquefaction) also can provide important information regarding the magnitude and timing of fault displacement in the site area or region.
4. Subsurface investigations may be necessary to evaluate location and activity of fault traces when uncertainty exists about the location or activity of a fault. These investigations may include trenches, test pits, and/or boreholes to permit detailed and direct observation of geologic units and faults.
5. The geometry of faults may be further defined by geophysical investigations including seismic refraction, seismic reflection, gravity, magnetic intensity, resistivity, ground penetrating radar, etc. These indirect methods require knowledge of specific geologic conditions for reliable interpretation.
6. Geophysical methods alone never prove the absence of a fault, and they typically do not identify the recency of activity.
7. More sophisticated and more costly studies may provide valuable data when special geological conditions exist or when requirements for critical structures demand a more intensive investigation. These methods might involve repeated geodetic surveys, strain measurements, or monitoring of microseismicity and radiometric analysis (C^{14} , K-Ar), stratigraphic correlation (fossils, mineralogy) soil profile development, paleomagnetism (magnetostatigraphy), or other dating techniques (thermoluminescence, cosmogenic isotopes) to evaluate the age of faulted or unfaulted units or surfaces.

The following information should be developed to provide documented support for conclusions relative to location and magnitude of faulting hazards:

1. Maps should be prepared showing the existence (or absence) and location of active faults on or near the site. The distribution of faulting (fault zone width) and fault-related surface deformation should be shown.
2. The type, amount, and sense of displacement of past surface faulting episodes should be documented, if possible.
3. From this documentation, estimates of location, magnitude, and likelihood or relative potential for future fault displacement can be made, preferably from measurements of past surface faulting events at the site, using the premise that the general pattern of past activity will repeat in the future. Estimates also may be made from published empirical correlations between fault displacement and fault length or earthquake magnitude (e.g., Wells and Coppersmith, 1994). Where fault segment length and sense of displacement are defined, these correlations may provide an estimate of future fault displacement (either the maximum or the average to be expected). Probabilistic studies may be considered to evaluate the probability of fault displacement (e.g., Youngs et al., 2003).
4. The degree of confidence and limitations of the data should be addressed.

Both deterministic and probabilistic methods are available for estimating the amount or probability of future fault displacement (e.g., Youngs et al., 2003). Because techniques for making these estimates are not standardized, peer review of reports is useful to verify the adequacy of the methods used and the estimated amount or frequency of movement, to aid the evaluation by the permitting agency, and to facilitate discussion between specialists that could lead to the development of standards.

The following guidelines are given for the safe siting of engineered construction in areas crossed by active faults:

1. Where ordinances have been developed that specify safe setback distances from traces of active faults or active fault zones, those distances must be complied with and accepted as the minimum for safe siting of buildings. ASCE/SEI 7 Section 11.8 precludes structures in Seismic Design Category E or F from being sited where there is a known potential for an active fault to cause rupture of the ground surface at the structure. States also may adopt more definitive requirements. For example, the general setback requirement in California is 50 feet from the traces of an active fault. That setback distance is mandated for structures near faults unless a site-specific special geologic investigation shows that a lesser distance could be safely applied (*California Code of Regulations*, Title 14, Division 2, Section 3603(a)).
2. In general, safe setback distances may be determined from geologic studies and analyses as noted above. Setback requirements for a site should be developed by the site engineers and geologists in consultation with professionals from the building and planning departments of the jurisdiction involved.

Where sufficient geologic data have been developed to accurately locate the zone containing active fault traces and the zone is not complex, a smaller setback distance may be specified. For complex fault zones, greater setback distances may be required. Dip-slip faults, with either normal or reverse motion, typically produce multiple fractures within rather wide and irregular fault zones. These zones generally are confined to the hanging-wall side of the fault leaving the footwall side little disturbed. Setback requirements for such faults may be rather narrow on the footwall side, depending on the quality of the data available, and larger on the hanging wall side of the zone. Some fault zones may contain broad deformational features such as pressure ridges and sags rather than clearly defined fault scarps or shear zones. Nonessential structures may be sited in these zones provided structural mitigative measures are applied as noted below. Studies by qualified geologists and engineers are required for such zones to assure that either (a) the structure is not sited across the trace of an active fault or (b) building foundations can withstand probable ground deformations in such zones.

Mitigation of Surface Faulting Hazards. There is no mitigative technology that can be used to prevent fault rupture from occurring. Thus, where a surface faulting hazard exists, the site must be avoided or the structure must be designed to withstand ground deformation or surface fault rupture.

In general practice, it is economically impractical to design a structure to withstand more than a few inches of fault displacement. Some buildings with strong foundations, however, have successfully withstood or diverted a few inches or even feet of surface fault rupture without damage to the structure (Youd, 1989; Kelson et al., 2001). Well reinforced mat foundations and strongly inter-tied footings have been most effective. Deep foundations such as driven piles or drilled shafts are not preferred. In general, less damage has been inflicted by compressional or shear displacement than by vertical or extensional displacements.

SEISMIC LATERAL EARTH PRESSURES

Determination of Lateral Pressures on Basement and Retaining Walls Due to Earthquake Motions. Paragraph 1 of Section 11.8.3 as modified by the 2009 *Provisions* Part 1 exception requires that seismic lateral pressures on basement walls

and retaining walls be determined for Seismic Design Category D, E, and F structures but does not specify the methods for calculating these pressures. Discussion and guidance regarding different approaches for determining seismic lateral pressures are given below.

Observations after past earthquakes have found that retaining walls for waterfront structures often have performed poorly in major earthquake due to excess pore water pressure and liquefaction conditions developing in relatively loose, saturated granular soils. However, damage reports for basement walls and retaining structures away from waterfronts are generally limited with only a few cases of stability failures or large permanent movements (Whitman, 1991). Due to the apparent conservatism or overstrength in static design of most walls, the complexity of nonlinear dynamic soil-structure interaction and the poor understanding of the behavior of retaining structures with cohesive or dense granular soils, Whitman (1991) recommends that “engineers must rely primarily on a sound understanding of fundamental principles and of general patterns of behavior.”

Seismic earth pressures on retaining walls are discussed below for two categories of walls: “yielding” walls that can move sufficiently to develop minimum active earth pressures and “nonyielding” walls that do not satisfy this movement condition. Note that in this context, yielding refers to permanent displacement of the wall as a result of the seismic event and does not mean that stresses within the structural system were exceeded. The amount of movement to develop minimum active pressure is very small. A displacement at the top of the wall of 0.002 times the wall height is typically sufficient to develop the minimum active pressure state. Generally, free-standing gravity or cantilever walls are considered to be yielding walls (except massive gravity walls founded on rock) whereas building basement walls restrained at the top and bottom often are considered to be nonyielding.

Yielding Walls. Limit Equilibrium Force Approach. At the 1970 Specialty Conference on Lateral Stresses in the Ground and Design of Earth Retaining Structures, Seed and Whitman (1970) made a significant contribution by reintroducing and reformulating the Mononobe-Okabe (M-O) seismic coefficient analysis (Mononobe and Matsuo, 1929; Okabe, 1926), the earliest method for assessing the dynamic lateral pressures on a retaining wall. The M-O method is a limit-equilibrium approach based on a Coulomb failure wedge with the assumption that the wall displaces or rotates outward sufficiently to produce the minimum active earth pressure state.

The M-O formulation is expressed as:

$$P_{AE} = (1/2)\gamma H^2 (1 - k_v)K_{AE} \quad (4)$$

where P_{AE} is the total (static + dynamic) lateral thrust, γ is unit weight of backfill soil, H is the height of backfill behind the wall, k_v is vertical ground acceleration divided by gravitational acceleration, and K_{AE} is the static plus dynamic lateral earth pressure coefficient which is dependent on (in its most general form) angle of friction of backfill, angle of wall friction, slope of backfill surface, and slope of back face of wall as well as horizontal and vertical ground acceleration. The formulation for K_{AE} is given in textbooks on soil dynamics (Prakash, 1981; Das, 1983; Kramer, 1996) and discussed in detail by Ebeling and Morrison (1992).

The value of a_{max} used in the K_{AE} determination is the instantaneous peak acceleration, not an average of the ground motion over the duration of strong shaking. In the past, it was common practice for geotechnical engineers to reduce the instantaneous peak by a factor from 0.5 to 0.7 to represent an average seismic coefficient for determining the seismic earth pressure on a wall. The reduction factor was introduced in a manner similar to the method used in a simplified liquefaction analyses to convert a random acceleration record to an equivalent average series of cyclic loads. This approach can result in confusion on the magnitude of the seismic active earth pressure and, therefore, is not recommended. Any further reduction to represent average rather than instantaneous peak loads is a structural decision and must be an informed decision made by the structural designer. As discussed in this paper in the section on the displacement-based approach, a reduction in a_{max} is, however, permitted if the wall can undergo permanent displacements. There is no consensus on the appropriate a_{max} value to use in the earth pressure determination. Recent centrifuge modeling work by Al Atik and Sitar (2007) suggests that estimating seismic lateral earth pressures utilizing the full peak ground acceleration overestimates the seismic earth pressure forces for some structures.

The M-O equation makes several other very important assumptions, including that the soil behind the retaining wall is a uniform, cohesionless soil and that the groundwater elevation is below the base of the retaining wall. The implications of these assumptions are discussed later in this section.

Seed and Whitman (1970), as a convenience in design analysis, proposed to evaluate the total lateral thrust, P_{AE} , in terms of its static component (P_A) and dynamic incremental component (ΔP_{AE}):

$$P_{AE} = P_A + \Delta P_{AE} \quad (5a)$$

or

$$K_{AE} = K_A + \Delta K_{AE} \quad (5b)$$

or

$$\Delta P_{AE} = (1/2)\gamma H^2 \Delta K_{AE} \quad (5c)$$

Seed and Whitman (1970), based on a parametric sensitivity analysis, further proposed that for practical purposes:

$$\Delta K_{AE} = (3/4)K_h \quad (6)$$

$$\Delta P_{AE} = (1/2)\gamma H^2 (3/4)k_h = (3/8)k_h \gamma H^2 \quad (7)$$

where k_h is horizontal ground acceleration divided by gravitational acceleration. Unless permanent displacement of the wall is acceptable, k_h should be taken equal to the site peak ground acceleration, a_{max} . For the distribution of the dynamic thrust, ΔP_{AE} , Seed and Whitman (1970) recommended that the resultant dynamic thrust act at $0.6H$ above the base of the wall (i.e., inverted trapezoidal pressure distribution). Note that this approach assumes dry, cohesionless backfill material. If soil conditions behind the wall have a cohesive soil component (i.e., a $c-\phi$ soil), this simplified approach is no longer appropriate.

Equation 7 generally is referred to as the simplified M-O formulation and is not applicable for sloping ground above the wall. For walls that are in excess of 15 feet in height, special studies also can be conducted to evaluate the coherency of ground motions behind the wall from which an average seismic coefficient can be developed. Anderson et al. (2008) provide simplified guidance on the selection of factors that adjust for coherency. These special studies require consideration of the frequency characteristics of ground motion, as well as the stiffness of the soil and the wall height, and usually require use of a finite element or difference computer model.

Since its introduction, there has been a consensus in geotechnical engineering practice that the simplified M-O formulation reasonably represents the dynamic (seismic) lateral earth pressure increment for yielding retaining walls. However, there are limitations associated with the M-O approach, and these limitations can have a significant effect on the magnitude of estimated seismic active earth pressure.

Although the M-O approach is simple to use, certain designs become very difficult to solve with the standard M-O equations. These designs involve high ground accelerations, combinations of moderate-to-high ground accelerations and steep backslopes, and mixed backfill conditions (i.e., either $c-\phi$ soils occur or only a thin zone of granular backfill is placed between the wall and the native soil behind the fill zone, particularly where the native soils is cohesive or rock). For these cases, the M-O approach does not provide realistic answers.

An acceptable alternative approach for these cases is to use a generalized limit equilibrium (slope stability) computer program. With this alternate approach, appropriate soil properties and geometry can be modeled, and the seismic coefficient can be defined on the basis of the peak ground acceleration or a reduced seismic coefficient if displacement is acceptable. For most seismic loading cases, the total stress (undrained) $c-\phi$ parameters will be appropriate for design because of the rate of seismic loading. With this generalized limit equilibrium method, the external force required for stability is computed. This force represents the dynamic earth pressure on the wall. The total force can be distributed as a uniform seismic pressure or the seismic increment can be determined and applied as an inverted triangle. Note that when subtracting the static force from the total seismic earth pressure, it is necessary to determine the static earth pressure under the conditions used during the pseudostatic seismic analysis. This could mean determining the static earth pressure for the same $c-\phi$ combination as used for the seismic analysis.

Displacement-based Approach. The alternate approach for the design of yielding walls is to evaluate the movement of the wall during seismic loading. Various methods are available for conducting displacement-based analyses ranging from extensions of the M-O formulations to two- and three-dimensional computer modeling. One of the key requirements for the displacement-based approach is the determination of the level of acceptable displacements. This determination will depend both on the wall type and on the nature of facilities next to the wall. These nearby facilities can range from buildings to buried utilities.

Careful attention needs to be given to the characterization of soil conditions behind the wall when using a displacement-based approach. Both the geometry of fill and native deposits, as well as the strength of the soil under cyclic loading, must be considered. Initially, the peak strength of the soil can be used for the analysis; however, if significant deformations are predicted, it may be necessary to repeat the analysis using the residual strength of the soil. See discussions of site characterization in the seismic slope stability section for additional guidance on the selection of soil strengths.

Richards and Elms (1979) introduced a method for seismic design analysis of yielding walls considering translational sliding as a failure mode and based on tolerable permanent displacements for the wall. Elms and Martin (1979) showed that $k_h =$

$a_{max}/2$ is adequate for design if the wall is allowed to slide up to $10a_{max}$ where a_{max} is the seismic ground motion and displacement is in inches. For seismically active areas, the displacement associated with $10 a_{max}$ can be 4 to 6 inches.

In practice, $k_h = a_{max}/2$ often is used without regard for the displacement that is associated with this assumption. Clearly, several inches of movement can be tolerable for some types of yielding walls, but not all. For example, a semi-gravity cantilever wall could be designed to slide several inches; however, the anchors for a tieback wall would likely restrict this level of movement from occurring for a well designed anchored wall. Use of $k_h = a_{max}/2$ requires that the designer check to confirm that deformations will develop without damaging the wall or other nearby facilities. Various factors can limit displacements, such as physical obstructions or underestimating the amount of soil strength that will be mobilized. If movement cannot be tolerated or if the wall may not move enough to mobilize the yield condition, then either the full a_{max} should be used for determination of seismic earth pressure or more rigorous procedures such as described below should be used.

There are a number of other empirical formulations for estimating permanent displacements under a translation mode of failure; these have been reviewed by Whitman and Liao (1985). Nadim (1980) and Nadim and Whitman (1984) incorporated the failure mode of wall tilting as well as sliding by employing coupled equations of motion that were further formulated by Siddharthan et al. (1992) as a design method to predict the seismic performance of retaining walls taking into account both sliding and tilting. Alternatively, Prakash et al. (1995) described design procedures and presented design charts for estimating both sliding and rocking displacements of rigid retaining walls. These design charts are the results of analyses for which the backfill and foundation soils were modeled as nonlinear viscoelastic materials. A simplified method that considers rocking of a wall on a rigid foundation about the toe was described by Steedman and Zeng (1996) and allows the determination of the threshold acceleration beyond which the wall will rotate. A simplified procedure for evaluating the critical threshold accelerations for sliding and tilting was described by Richards et al. (1996).

Validation of methods for evaluating tilting of yielding walls has been limited to a few case studies and back-calculation of laboratory test results. Evaluation of wall tilting requires considerable engineering judgment. Because the tilting mode of failure can lead to instability of a yielding retaining wall, it is suggested that this mode of failure be avoided in the design of new walls by proportioning the walls to prevent rotation in order to displace only in the sliding mode.

An alternative displacement-based approach is the use of two-dimensional computer codes such as FLAC and PLAXIS. These methods allow a more detailed evaluation of soil-structure interaction for different wall geometries and external loads, different soil and structural properties, and different earthquake loading conditions. Results from these analyses can be particularly helpful in understanding the deformations that occur within and near the retaining wall including the soil in front of and behind the wall. As noted above, these methods require considerable expertise in terms of soil and structural modeling and selection of earthquake records and should be used with particular care. Although results may appear very reasonable, small changes in model setup or input parameters selection can significantly affect the quality of results, potentially leading to unconservative design decisions.

Nonyielding Walls. By definition, nonyielding walls do not deform when subjected to seismic earth pressures. This type of response requires a very stiff wall in combination with a rigid base condition. Most nonyielding walls will be located on rock or very stiff soil. Even in this condition, wall flexibility can be sufficient to develop active seismic earth pressures significantly reducing the loading on basement walls. Where a basement wall is located on rock or very stiff soil and where structural analyses determine that the wall flexibility is such that deformations will not develop seismic active earth pressures (i.e., deformations $< 0.002H$ where H is the wall height), the wall should be designed as a nonyielding wall. The following discussion provides guidance on two methods for dealing with cases where rigid wall conditions occur. Also included is a discussion of soil-structure interaction methods for evaluating earth pressures on basement walls where uncertainties on the flexibility of the wall occur.

Simplified Wood Approach. Wood (1973) analyzed the response of a rigid nonyielding wall retaining a homogeneous linear elastic soil and connected to a rigid base. For such conditions, Wood established that the dynamic amplification was insignificant for relatively low-frequency ground motions (i.e., motions at less than half of the natural frequency of the unconstrained backfill), which would include many earthquake problems. For uniform, constant k_h applied throughout the elastic backfill, Wood (1973) developed the dynamic thrust, ΔP_E , acting on smooth rigid nonyielding walls as:

$$\Delta P_E = F k_h \gamma H^2 \quad (8)$$

The value of F is approximately equal to unity (Whitman, 1991) leading to the following approximate formulation for a rigid nonyielding wall on a rigid base:

$$\Delta P_E = k_h \gamma H^2 \quad (9)$$

As for yielding walls, the point of application of the dynamic thrust is taken typically at a height of $0.6H$ above the base of the wall.

It should be noted that the model used by Wood (1973) does not incorporate any effect on the pressures of the inertial response of a superstructure connected to the top of the wall. This effect may modify the interaction between the soil and the wall and thus modify the pressures from those calculated assuming a rigid wall on a rigid base.

Although the study performed by Wood included dynamic analysis of a rigid wall with fixed base condition, the solution commonly used and presented in Equations 8 and 9 is based on static “1g” loading of the soil and wall and does not include the effects of the wave propagation in the soil. The subject of soil-wall interaction is addressed in the following sections.

Ostadan Rigid Wall Approach. Ostadan (2005) observed that for partially embedded structures subjected to ground shaking, the characteristics of the dynamic earth pressure amplitudes versus frequency of the ground motion were those of a single-degree-of-freedom (SDOF) system and proposed a simplified method to estimate the magnitude and distribution of dynamic thrust. Results provided by Ostadan (2005) utilizing this simplified method, which also were confirmed by dynamic finite element analyses, indicate that, depending on the dynamic properties of the backfill as well as the frequency characteristics of the input ground motion, a range of dynamic earth pressure solutions would be obtained for which the M-O solution and the Wood (1973) solution represent a “lower” and an “upper” bound, respectively.

The solution by Ostadan considers the kinematic soil-structure interaction effects and is based on the dynamic soil properties and the ground motion characteristics. This solution assumes a rigid wall on rigid foundation and does not include the effect of the superstructure and its inertia on seismic soil pressure.

The five-step method to compute the seismic soil pressure following Ostadan’s method is:

1. Perform free-field soil column analysis and obtain the ground response motion at the depth corresponding to the base of the wall in the free-field. The response motion in terms of acceleration response spectrum at 30 percent damping should be obtained. The free-field soil column analysis may be performed using the computer program SHAKE with input motion specified either at the ground surface or at the depth of the foundation basemat. The choice for location of control motion should be consistent with the development of the ground motion.
2. Use Equation 10 to compute the total soil mass (m) using the Poisson’s ratio (ν) and mass density of the soil.

$$m = 0.50(\rho)H^2 (\Psi\nu) \quad (10)$$

where ρ is the mass density of the soil (total weight density divided by acceleration of gravity), H is the height of the wall, and $\Psi\nu$ is a factor to account for the Poisson’s ratio as defined by the following equation.

$$\Psi\nu = 2 / [(1-\nu)(2-\nu)]^{0.5} \quad (11)$$

3. Obtain the total lateral seismic force from the product of the total mass obtained in Step 2 and the acceleration spectral value of the free-field response at the soil column frequency obtained at the depth of the bottom of the wall (Step 1). The soil column frequency (f_s) is an output provided by SHAKE:

$$f_s = v_s/(4H) \quad (12)$$

where v_s is the average strain-compatible shear wave velocity of the soil column over the height of the wall.

4. Obtain the maximum lateral seismic soil pressure at the ground surface level by dividing the lateral force obtained in Step 3 by the area under the normalized seismic soil pressure, $0.744H$.
5. Obtain the pressure profile by multiplying the peak pressure from Step 4 by the pressure distribution relationship given by:

$$p(y) = -0.0015 + 5.05y - 15.84y^2 + 28.25y^3 - 24.59y^4 + 8.14y^5 \quad (13)$$

where y is the normalized height ratio (Y/H) measured from the bottom of the wall (ranging from 0 at the bottom of the wall to 1 at the top of the wall) and Y is the distance of the point under consideration from the bottom of the wall.

The area under the seismic soil pressure curve can be obtained from integration of the pressure distribution over the height of the wall. The total area is $0.744H \times p_{\max}$ for a wall with the height of H and maximum pressure of p_{\max} at the top.

With this method, the site-specific dynamic soil properties, soil nonlinear effects, and the characteristics of the ground motion are considered in the computation of the seismic soil pressure. A complete verification of the five-step method against finite element solutions and comparison with the Wood solution and the M-O method is presented by Ostadan (2005).

Soil-structure-interaction Approach and Modeling for Partially Embedded Structures. Lam and Martin (1986), Soydemir and Celebi (1992), Veletsos and Younan (1994a and 1994b), and Ostadan (2005), among others, argue that the earth pressures acting on the walls of partially embedded structures (e.g., basement walls) during earthquakes are primarily governed by soil-structure interaction (SSI) and, thus, these partially embedded structures should not be treated as a nonyielding wall. Soil-structure interaction includes both a kinematic component -- i.e., the interaction of a massless rigid wall with the adjacent soil as modeled by Wood (1973) but including the wave propagation in the soil -- and an inertial component -- i.e., the interaction of the wall, connected to a responding superstructure, with the adjacent soil. Detailed SSI analyses incorporating kinematic and inertial interaction may be considered for the estimation of seismic earth pressures on critical walls.

Whitman (1991) has suggested that SSI effects on basement walls of buildings reduce dynamic earth pressures and that M-O pressures may be used in design except where structures are founded on rock or hard soil (i.e., where no significant rocking occurs). In the latter case, the pressures given by the Ostadan (2005) method with the Wood (1973) formulation as the upper bound would appear to be more applicable. The effect of rocking in reducing the dynamic earth pressures on basement walls also has been suggested by Ostadan and White (1998). This condition may be explained if it is demonstrated that the dynamic displacements induced by kinematic and inertial components are out of phase. Chang et al. (1990) have found that dynamic earth pressures recorded on the wall of a large-scale model nuclear reactor containment building (e.g., 1/4 the size of a full-size power block) were consistent with dynamic pressures predicted by the M-O solution. Analyses by Chang et al. (1990) indicate that the dynamic wall pressures were strongly correlated with the rocking response of the structure.

Effect of Saturated Backfill on Wall Pressures. The previous discussions of yielding and nonyielding walls are limited to backfills that are not water-saturated. In current (2009) practice, drains typically are incorporated in the design to prevent groundwater from building up within the backfill. This is not practical or feasible, however, for waterfront structures (e.g., quay walls) where most of the earthquake-induced failures have been reported (Seed and Whitman, 1970; Ebeling and Morrison, 1992; ASCE-TCLEE, 1998) or for some types of structures located below groundwater.

During ground shaking, the presence of water in the pores of a backfill can influence the seismic loads that act on the wall in three ways (Ebeling and Morrison, 1992; Kramer, 1996): (a) by altering the inertial forces within the backfill, (b) by developing hydrodynamic pressures within the backfill, and (c) by generating excess porewater pressure due to cyclic straining. Effects of the presence of water in cohesionless soil backfill on seismic wall pressures can be estimated using formulations presented by Ebeling and Morrison (1992) and Kramer (1996). The effects of soil liquefaction associated with excess porewater pressure generation on wall pressures are treated in the discussion of increased lateral earth pressure in the liquefaction hazard section of this resource paper.

REFERENCES

- American Society of Civil Engineers, Technical Committee on Lifeline Earthquake Engineering. 1998. *Seismic Guidelines for Ports*, edited by S. D. Werner, Monograph 12. ASCE, Reston, Virginia.
- Al Atik, L., and N. Sitar. 2007. "Dynamic Centrifuge Study of Seismically Induced Lateral Earth Pressures," in *Proceedings, 4th International Conference on Earthquake Geotechnical Engineering*. EERI, Oakland, California.
- Anderson, D. G., G. R. Martin, I. P. Lam, and J. N. Wang. 2008. *Seismic Design and Analysis of Retaining Walls, Buried Structures, Slopes and Embankments*, NCHRP Report 611. Transportation Research Board, National Cooperative Highway Research Program, Washington, D.C.
- Ashford, S. A., T. Juirnarongrit, T. Sugano, and M. Hamada. 2006. "Soil-Pile Response to Blast-Induced Lateral Spreading. I. Field Test," *ASCE/SEI Journal of Geotechnical and Geoenvironmental Engineering*, 132(2).
- Ashford, S. A., K. M. Rollins, and J. D. Lane. 2004. "Blast-Induced Liquefaction for Full-Scale Foundation Testing," *ASCE/SEI Journal of Geotechnical and Geoenvironmental Engineering*, 130(8).
- Bardet, J. P., T. Tobita, N. Mace, and J. Hu. 2002. "Regional Modeling of Liquefaction-Induced Ground Deformation," *Earthquake Spectra*, 18(1): 19-46.
- Blake, T. F., R. A. Hollingsworth, and J. P. Stewart, editors. 2002. *Recommended Procedures for Implementation of DMG Special Publication 117, Guidelines for Analyzing and Mitigating Landslide Hazards in California*. Southern California Earthquake Center, University of Southern California, Los Angeles, California.
- Boulanger, R. W., and I. M. Idriss. 2006. "Liquefaction Susceptibility Criteria for Silts and Clays," *ASCE/SEI Journal of Geotechnical and Geoenvironmental Engineering*, 132(11).
- Bray, J. D., and E. M. Rathje. 1998. "Earthquake-induced Displacements of Solid-waste Landfills," *ASCE/SEI Journal of Geotechnical and Geoenvironmental Engineering*, 124: 242-253.

- Bray, J. D., E. M. Rathje, A. J. Augello, and S. M. Merry. 1998. "Simplified Seismic Design Procedure for Geosynthetic-Lined, Solid-Waste Landfills," *Geosynthetics International* 5(1-2).
- Bray, J. D., and R. B. Sancio. 2006. "Assessment of the Liquefaction Susceptibility of Fine-Grained Soils," *ASCE/SEI Journal of Geotechnical and Geoenvironmental Engineering*, 132(9).
- California Geological Survey. 2008. *Guidelines for Evaluating and Mitigating Seismic Hazards in California*, Special Publication 117A.
- California Geological Survey. 2002. *Guidelines for Evaluating the Hazard of Surface Fault Rupture*, California Geological Survey Note 49.
- Cetin, K. O., R. B. Seed, A. Der Kiureghian, K. Tokimatsu, L. F. Harder, R. E. Kayen, and R. E. S. Moss. 2004. "Standard Penetration Test-Based Probabilistic and Deterministic Assessment of Seismic Soil Liquefaction Potential," *ASCE/SEI Journal of Geotechnical and Geoenvironmental Engineering*, 130(12).
- Chang, C. Y., M. S. Power, C. M. Mok, Y. K. Tang, and H. T. Tang. 1990. "Analysis of Dynamic Lateral Earth Pressures Recorded on Lotung Reactor Containment Model Structure," in *Proceedings, Fourth U.S. National Conference on Earthquake Engineering*. EERI, Oakland, California.
- Das, B. M. 1983. *Fundamentals of Soil Dynamics*. Elsevier, New York, New York.
- Dobry, R., R. S. Ladd, F. Y. Yokel, R. M. Chung, and D. Powell. 1982. "Prediction of Pore Water Pressure Buildup and Liquefaction of Sands During Earthquakes by the Cyclic Strain Method," National Bureau of Standards Building Science Series 138. NIST, Gaithersburg, Maryland.
- Duku, P. M., J. P. Stewart, D. H. Whang, and E. Yee. 2008. "Volumetric Strains of Clean Sands Subject to Cyclic Loads," *ASCE/SEI Journal of Geotechnical and Geoenvironmental Engineering*, 134(8).
- Ebeling, R. M., and E. E. Morrison. 1992. *The Seismic Design of Waterfront Retaining Structures*, Technical Report ITL-92-11. U.S. Army Corps of Engineers Waterways Experiment Station, Vicksburg, Mississippi.
- Elms, D. A., and G. R. Martin. 1979. "Factors Involved in the Seismic Design of Bridge Abutments," in *Proceedings of the Workshop on Seismic Problems Related to Bridges*. Applied Technology Council, Redwood City, California.
- Franklin, A. G., and F. K. Chang. 1977. "Earthquake Resistance of Earth and Rock-Fill Dams; Permanent Displacements of Earth Embankments by Newmark Sliding Block Analysis," Miscellaneous Paper S-71-17, Report 5. U.S. Army Corps of Engineers Waterways Experiment Station, Vicksburg, Mississippi.
- Goodman, R. E., and H. B. Seed. 1966. "Earthquake-induced Displacements in Sand Embankments," *ASCE/SEI Journal of Soil Mechanics and Foundation*, 92(SM2).
- Hart, E. W., and W. A. Bryant. 1997 (revised). *Fault-rupture Hazard Zones in California*, Special Publication 42. California Department of Conservation, Division of Mines and Geology (now California Geological Survey).
- Hanson, K. L., K. I. Kelson, M. A. Angell, and W. R. Lettis. 1999. *Techniques for Identifying Faults and Determining Their Origin*, NUREG/CR-5503. U.S. Nuclear Regulatory Commission.
- Hynes, M. E., and A. G. Franklin. 1984. "Rationalizing the Seismic Coefficient Method," Miscellaneous Paper GL-84-13. U.S. Army Corps of Engineers Waterways Experiment Stations, Vicksburg, Mississippi.
- Idriss, I. M. 1985. "Evaluating Seismic Risk in Engineering Practice" in *Proceedings of the 11th International Conference on Soil Mechanics and Foundation Engineering*, Vol. 1, p. 155.
- Idriss, I. M., and R. W. Boulanger. 2004. "Semi-empirical Procedures for Evaluating Liquefaction Potential During Earthquakes," in *Proceedings of the 11th International Conference on Soil Dynamics and Earthquake Engineering, and 3rd International Conference on Earthquake Geotechnical Engineering*, Vol. 1, pp 32-56. Stallion Press, Hawthorne, California.
- Idriss, I. M., and R. W. Boulanger. 2008. *Soil Liquefaction During Earthquakes*, Monograph MNO-12. Earthquake Engineering Research Institute, Oakland, California.
- Idriss, I. M., and R. W. Boulanger. 2007. "SPT and CPT-based Relationships for the Residual Shear Strength of Liquefied Soils," *Earthquake Geotechnical Engineering*, edited by K. D. Titilakis,
- Idriss, I. M., and R. W. Boulanger. 2006. "Semi-empirical Procedures for Evaluating Liquefaction Potential During Earthquakes," *Soil Dynamic and Earthquake Engineering*, 26: 115-130.
- Ishihara, Kenji. 1985. "Stability of Natural Deposits during Earthquakes" in *Proceedings of the 11th International Conference on Soil Mechanics and Foundation Engineering*, Vol. 1, pp. 321-376.
- Ishihara, K., and M. Yoshimine. 1992. "Evaluation of Settlements in Sand Deposits Following Liquefaction During Earthquakes," *Soils and Foundations*, JSSMFE, 32(1).
- Itasca Consulting Group. 1997. *User's Manual for FLAC, V. 3.4*. Itasca, Minneapolis, Minnesota.
- Jibson, R. W., and M. W. Jibson. 2003. *Java Programs for Using Newmark's Method and Simplified Decoupled Analysis to Model Slope Performance During Earthquakes*, U.S. Geological Survey Open-File Report 03-005, Version 1.0.

- Jibson, R. W. 1993. "Predicting Earthquake-Induced Landslide Displacements Using Newmark's Sliding Block Analysis," in *Earthquake-Induced Ground Failure Hazards*, Transportation Research Record, No. 1411. Transportation Research Board. National Research Council, Washington, D.C.
- Kagawa, T., M. Sata, C. Minowa, A. Abe, and T. Tazoh. 2004. "Centrifuge Simulations of Large-Scale Shaking Table Tests: Case Studies," *ASCE/SEI Journal of Geotechnical and Geoenvironmental Engineering*, 130(7).
- Kelson, K. I., K.-H. Kang, W. D. Page, C.-T. Lee, and L. S. Cluff. 2001. "Representative styles of deformation along the Chelungpu fault from the 1999 Chi-Chi (Taiwan) Earthquake: Geomorphic characteristics and responses of man-made structures," *Bulletin of the Seismological Society of America*, 91(5): 930-952.
- Kramer, S. L. 1996. *Geotechnical Earthquake Engineering*. Prentice Hall, New Jersey.
- Kramer, S. L., and R. T. Mayfield. 2007. "Return Period of Soil Liquefaction." *ASCE/SEI Journal of Geotechnical and Geoenvironmental Engineering*, 133(7).
- Lam, I., and G. R. Martin. 1986. *Seismic Design of Highway Bridge Foundations -- Design Procedures and Guidelines*, Report FHWA/RD-86/102. Federal Highway Administration, Washington, D.C.
- Liu, A. H., J. P. Stewart, N. A. Abrahamson, and Y. Moriwaki. 2001. "Equivalent Number of Uniform Stress Cycles for Soil Liquefaction Analysis," *ASCE/SEI Journal of Geotechnical and Geoenvironmental Engineering*, 127(12).
- Makdisi, F. T., and H. B. Seed. 1978. "Simplified Procedure for Estimating Dam and Embankment Earthquake-Induced Deformations." *ASCE/SEI Journal of Geotechnical Engineering*, 104(GT7).
- Martin, G. R., and P. Qiu. 1994. "Effects of Liquefaction on Vulnerability Assessment," NCEER Highway Project on Seismic Vulnerability of New and Existing Highway Construction, One Year Research Tasks – Technical Research Papers. NCEER, State University of New York, Buffalo.
- Martin, G. R., and M. Lew. 1999. *Recommended Procedures for Implementation of DMG Special Technical Publication 117, Guidelines for Analyzing and Mitigating Liquefaction in California*. Southern California Earthquake Center, University of Southern California.
- Monobe, N., and H. Matsuo. 1929. "On the Determination of Earth Pressures During Earthquakes" in *Proceedings, World Engineering Congress*.
- Moss, R. E. S., R. B. Seed, R. E. Kayen, J. P. Stewart, A. Der Kiureghian, and K. O. Cetin. 2006. "CPT-Based Probabilistic and Deterministic Assessment of In Situ Seismic Soil Liquefaction Potential," *ASCE/SEI Journal of Geotechnical and Geoenvironmental Engineering*, 132(8).
- Nadim, F. 1980. "Tilting and Sliding of Gravity Retaining Walls," MS thesis, Department of Civil Engineering, Massachusetts Institute of Technology, Cambridge.
- Nadim, F., and R. V. Whitman. 1984. "Coupled Sliding and Tilting of Gravity Retaining Walls During Earthquakes" in *Proceedings of the Eighth World Conference on Earthquake Engineering*, pp. 477-484. National Center for Earthquake Engineering Research (NCEER). 1997. *Proceedings of the NCEER Workshop on Evaluation of Liquefaction Resistance of Soils*, Technical Report NCEER-97-0022. NCEER, State University of New York, Buffalo.
- National Research Council, Committee on Earthquake Engineering. 1985. *Liquefaction of Soils during Earthquakes*. National Academy Press, Washington, D.C.
- Newmark, N. M. 1965. "Effects of Earthquakes on Dams and Embankments," *Geotechnique* (London, England), 5(2).
- Okabe, S. 1926. "General Theory of Earth Pressure," *Journal of the Japan Society of Civil Engineers*, 12(1).
- Olson, S. M., and C. I. Johnson. 2008. "Analyzing Liquefaction-Induced Lateral Spreads Using Strength Ratios," *ASCE/SEI Journal of Geotechnical and Geoenvironmental Engineering*, 134(8).
- Olson, S. M., and T. D. Stark. 2002. "Liquefied Strength Ratio from Liquefaction Flow Failure Case Histories," *Canadian Geotechnical Journal*, 39(June).
- Ostadan, F. 2005. "Seismic Soil Pressure for Building Walls – an Updated Approach," *Journal of Soil Dynamics and Earthquake Engineering*, 25: 785-793; also published in *Proceedings of the 11th International Conference on Soil Dynamics and Earthquake Engineering and 3rd International Conference on Earthquake Geotechnical Engineering*, University of California, Berkeley, 2004.
- Ostadan, F., and W. H. White. 1998. "Lateral Seismic Soil Pressure -- An Updated Approach," in *Preproceedings of UJNR Workshop on Soil-Structures Interaction*, U.S. Geological Survey, Menlo Park, California.
- Plaxis. 2008. *Plaxis Dynamics – A 2-Dimensional Program for Evaluating Response of Soil-Structure Systems to Earthquake Loading*, Plaxis BV, The Netherlands.
- Prakash, S. 1981. *Soil Dynamics*. McGraw-Hill Book Co., New York, New York.
- Prakash, S., Y. Wu, and E. A. Rafnsson. 1995. *Displacement Based Aseismic Design Charts for Rigid Walls*. Shamsheer Prakash Foundation, Rolla, Missouri.

- Rathje, E. M., and G. Saygili. 2008. "Probabilistic Seismic Hazard Analysis for the Sliding Displacement of Slopes: Scalar and Vector Approaches," *ASCE/SEI Journal of Geotechnical and Geoenvironmental Engineering*, 134(6).
- Rausch, A. F., and J. M. Martin. 2000. "EPOLLS Model for Predicting Average Displacement on Lateral Spreads," *ASCE/SEI Journal of Geotechnical and Geoenvironmental Engineering*, 126(4).
- Richards, R. J., and D. Elms. 1979. "Seismic Behavior of Gravity Retaining Walls," *ASCE/SEI Journal of the Geotechnical Engineering Division*, 105(GT4).
- Richards, R., K. L. Fishman, and R. Devito. 1996. "Threshold Accelerations for Rotation or Sliding of Bridge Abutments," *ASCE/SEI Journal of Geotechnical Engineering*, 105(GT4).
- Saygili, G., and E. M. Rathje. 2008. "Empirical Predictive Models for Earthquake-Induced Sliding Displacements of Slopes," *ASCE/SEI Journal of Geotechnical and Geoenvironmental Engineering*, 134(6).
- Seed, H. B., and I. M. Idriss. 1971. "Simplified Procedure for Evaluating Soil Liquefaction Potential," *Journal of the ASCE/SEI Soil Mechanics and Foundations Division*, 97(SM9).
- Seed, H. B., K. Tokimatsu, L. F. Harder, and R. M. Chung. 1985. *The Influence of SPT Procedures in Soil Liquefaction Resistance Evaluations*, Report UBC/EERC-84/15. Earthquake Engineering Research Center, Berkeley, California.
- Seed, H. B., and I. M. Idriss. 1982. *Ground Motions and Soil Liquefaction During Earthquakes*, Vol. 5 of *Engineering Monographs on Earthquake Criteria, Structural Design, and Strong Motion Records*. Earthquake Engineering Research Institute, El Cerrito, California.
- Seed, H. B., and R. V. Whitman. 1970. "Design of Earth Retaining Structures for Dynamic Loads," in *Proceedings, ASCE/SEI Specialty Conference on Lateral Stresses in the Ground and Design of Earth-Retaining Structures*, pp. 103-147. Cornell University, Ithaca, New York.
- Seed, R. B., and L. F. Harder. 1990. "SPT-Based Analysis of Cyclic Pore Pressure Generation and Undrained Residual Strength," in *Proceedings of the H. Bolton Seed Memorial Symposium*, Vol. 2, BiTech Publishers, Ltd, Vancouver, pp. 351-376.
- Siddharthan, R., S. Ara, and G. Norris. 1992. "Simple Rigid Plastic Model for Seismic Tilting of Rigid Walls," *ASCE/SEI Journal of Structural Engineering*, Vol. 118, No. 2, pp. 469-487.
- Slemmons, D. B., and C. M. dePolo. 1986. "Evaluation of Active Faulting and Associated Hazards," in *Studies in Geophysics -- Active Tectonics*, pp. 45-62. National Academy Press, Washington, D.C.
- Soydemir, C., and M. Celebi. 1992. "Seismic Design of Buildings with Multi-Level Basements," in *Proceedings, Tenth World Conference on Earthquake Engineering*, Madrid, Spain, Vol. 6, Balkema, Rotterdam, pp. 1731-1734.
- Steedman, R. S., and X. Zeng. 1996. "Rotation of Large Gravity Retaining Walls on Rigid Foundations Under Seismic Loading," in *Analysis and Design of Retaining Walls Against Earthquakes*, ASCE/SEI Geotechnical Special Publication 60, edited by S. Prakash, pp. 38-56. ASCE, Reston, Virginia.
- Stewart, J. P., T. M. Blake, and R. A. Hollingsworth. 2003. "A Screen Analysis Procedure for Seismic Slope Stability," *Earthquake Spectra*, 19(3).
- Swan, F. H., J. C. Stepp, and R. K. McGuire. 1991. "Assessment of the Potential for Tectonic Fault Rupture for High-Level Nuclear Waste Repositories," *Quarterly Journal of Engineering Geology*, 24: 337-346.
- Tokimatsu, K., and H. B. Seed. 1987. "Evaluation of Settlements in Sands Due to Earthquake Shaking," *ASCE/SEI Journal of Geotechnical Engineering*, 113(8).
- U.S. Army Corps of Engineers. 2005. Design: Seismic Design for Buildings, Unified Facilities Criteria, UFC 3-310-03A, formerly TI-809-04 (1998), Appendix F, Geologic Hazards Evaluations.
- Utah Section of the Association of Engineering Geologists. 1987. Guidelines for Evaluating Surface Fault Rupture Hazard in Utah, Utah Geological and Mineral Survey Miscellaneous Publication N.
- Veletsos, A., and A. H. Younan. 1994a. "Dynamic Soil Pressure on Rigid Vertical Walls," *Earthquake Engineering and Soil Dynamics*, 23: 275-301.
- Veletsos, A. and A. H. Younan. 1994b. "Dynamic Modeling and Response of Soil-Wall Systems," *ASCE/SEI Journal of Geotechnical Engineering*, 120(12).
- Wells, D. L., and K. J. Coppersmith. 1994. "New Empirical Relationships Among Magnitude, Rupture Area, and Surface Displacement," *Bulletin of the Seismological Society of America*, 84: 974-1002.
- Whitman, R. V. 1991. "Seismic Design of Earth Retaining Structures," in *Proceedings, Second International Conference on Recent Advances in Geotechnical Earthquake Engineering and Soil Dynamics*, St. Louis, Missouri.
- Whitman, R. V., and S. Liao. 1985. *Seismic Design of Retaining Walls*, Miscellaneous Paper GL-85-1. U.S. Army Corps of Engineers Waterways Experiment Station, Vicksburg, Mississippi.

- Wong, C. P., and R. V. Whitman. 1982. "Seismic Analysis and Improved Seismic Design Procedure for Gravity Retaining Walls," Research Report 82-83. Department of Civil Engineering, Massachusetts Institute of Technology, Cambridge.
- Wood, J. H. 1973. *Earthquake-Induced Soil Pressures on Structures*, Report EERL 73-05. California Institute of Technology, Pasadena.
- Youd, T. L. 1989. "Ground Failure Damage to Buildings during Earthquakes," in *Foundation Engineering -- Current Principles and Practices*, Vol. 1, pp. 758-770. American Society of Civil Engineers, Reston, Virginia.
- Youd, T. L., and C. T. Garris. 1995. "Liquefaction-Induced Ground Surface Disruption," *ASCE/SEI Journal of Geotechnical Engineering*, 121(11).
- Youd, T. L., and S. K. Noble. 1997. "Magnitude Scaling Factors," in *Proceedings of the NCEER Workshop on Evaluation of Liquefaction Resistance of Soils*, pp. 149-165. National Center for Earthquake Engineering Research, State University of New York, Buffalo.
- Youd, T. L., C. M. Hansen, and S. F. Bartlett. 2002. "Revised Multilinear Regression Equations for Prediction of Lateral Spread Displacement," *ASCE, Journal of Geotechnical and Geoenvironmental Engineering*, 128(12).
- Youd, T. L., I. M. Idriss, R. D. Andrus, I. Arango, G. Castro, J. T. Christian, R. Dobry, W. Finn, D. L. Harder, Jr., M. E. Hynes, K. Ishihara, J. P. Koester, S. S. C. Liao, W. F. Marcuson III, G. R. Martin, J. K. Mitchell, Y. Moriwaki, M. S. Power, P. K. Robertson, R. B. Seed, and K. H. Stokoe II. 2001. "Liquefaction Resistance of Soils: Summary Report from the 1996 NCEER and 1998 NCEER/NSF Workshops on Evaluation of Liquefaction Resistance of Soils," *ASCE/SEI Journal of Geotechnical Geoenvironmental Engineering*, 127(10).
- Youngs, R. R., W. J. Arabasz, R. E. Anderson, A. R. Ramelli, J. P. Ake, D. B. Slemmons, J. P. McCalpin, D. I. Doser, C. J. Fridrich, F. H. Swan III, A. M. Rogers, J. C. Yount, L. W. Anderson, K. D. Smith, R. L. Bruhn, P. L. K. Kneupfer, R. B. Smith, C. M. dePolo, D. W. O'Leary, K. J. Coppersmith, S. K. Pezzopane, D. P. Schwartz, J. W. Whitney, S. S. Olig, and G. R. Toro. 2003. "A Methodology for Probabilistic Fault Displacement Hazard Analysis (PFDHA)," *Earthquake Spectra*, 19(1).
- Zhang, G., P. K. Robertson, and R. W. I. Brachman. 2004. "Estimating Liquefaction-Induced Lateral Displacements Using the Standard Penetration Test of Cone Penetration Test," *ASCE Journal of Geotechnical and Geoenvironmental Engineering*, 130(8).

Page intentionally left blank.

Resource Paper 13

LIGHT-FRAME WALL SYSTEMS WITH WOOD STRUCTURAL PANEL SHEATHING

This resource paper provides commentary on shear wall design, performance, and the state of practice for seismic-force-resisting systems using light-frame walls with wood structural panel sheathing as recognized in ASCE/SEI 7-05 (ASCE/SEI 7) Table 12.2-1, Items A13 and B23. This commentary is intended to supplement existing application-oriented commentary provided by the applicable American Iron and Steel Institute (AISI) and American Forest and Paper Association (AF&PA) standards and is being provided with the intent that applicable portions be integrated into relevant standards or other design guidance documents.

GLOBAL STRENGTH, DRIFT, AND DUCTILITY

Wood and cold-formed steel (CFS) light-frame structures using wood structural panel shear walls for seismic resistance rely on a significant level of ductility and displacement capacity in addition to strength. Vertical elements of the lateral-force-resisting system will often have strength-level (LRFD) calculated deflections of between 0.5 and 0.75 percent of the story height under the design-based earthquake (DBE), implying an expected real interstory drift (d_u) on the order of 2 to 3 percent of the story height for the DBE and more for the risk-targeted maximum considered earthquake (MCE_R). Although nonlinear time-history analysis, laboratory shake table testing (wood light-frame systems), and observed building performance suggest this level of drift can occur, all three also indicate that drifts can be substantially less (Cecotti and Karacabeyli, 2002; Christovasilis et al., 2007; CUREE, 2001a, 2001b, 2002a, 2002b, and 2002c; Pryor et al., 2000). This wide variation in response is primarily attributable to the added strength and stiffness of finish materials on both the interior and exterior of the structure as well as other sources of redundancy. Several shake table studies have underscored this contribution of finish material (CUREE, 2001b; Christovasilis et al., 2007). Testing and analysis of structures with finishes included have also shown a tendency for drifts in multistory light-frame buildings to be concentrated in the lowest story which is typically the softest and weakest.

ELEMENTS IN THE LATERAL-FORCE-RESISTING SYSTEM

Laboratory shake table testing and observed building performance to date indicate that the primary seismic response of light-frame wood structural panel shear wall buildings is the in-plane racking displacement of the wall elements while the deformation demand on floor and roof diaphragms remains small. The few recorded instances of diaphragm failures in light-frame buildings have involved irregularly shaped diaphragms with re-entrant corners (CUREE, 2001a; Christovasilis et al., 2007). Consequently, the walls are the structural elements that determine the seismic response characteristics of light-frame shear wall buildings. Note that light-frame diaphragms can have a significant influence on the seismic behavior of concrete and masonry shear wall buildings, which are beyond the scope of this paper.

Wood structural panel sheathed shear wall systems are intended to be designed in accordance with ASCE/SEI 7-05, AF&PA *Special Design Provisions for Wind and Seismic* for wood construction, and AISI S213-07, *North American Standard for Cold-Formed Steel Framing – Lateral Design* for CFS construction. Structural assemblies in light-frame construction are formed by a system of closely spaced repetitive wood or cold-formed steel (CFS) floor, roof, and wall framing members. In wood structural panel shear wall systems, sheathing is most commonly installed in 4 foot by 8 to 10 foot sheets and fastened to wall framing with nails, screws, or similar small diameter dowel-type fasteners.

Seismic design in accordance with ASCE/SEI 7 anticipates cyclic loading of vertical shear wall elements in the inelastic range, often to or beyond peak capacity. The primary source of drift and energy dissipation of wood-frame shear walls is the bending and yielding of the shear wall sheathing to framing fasteners around the perimeter of each sheathing panel accompanied by slip between the sheathing and framing. In most wood-frame shear walls, the racking of the wall causes yielding of sheathing to framing fasteners, along with local crushing of the framing and sheathing due to fastener bearing. In most CFS frame shear walls, the racking of the wall causes fastener-related bearing deformations along with dimpling of the framing members. The sheathing in both wood and CFS walls rotates about its center of rigidity and the maximum number of fasteners is engaged in resisting the lateral loads.

Addressed here are the combinations of sheathing and fastening currently included in the American Forest and Paper Association (AF&PA) and American Iron and Steel Institute (AISI) standards. New combinations of sheathing and fastening should be tested in reverse-cyclic loading; some combinations of sheathing materials and methods of attachment (such as

adhesive) have not shown similar ductility levels in laboratory tests. This paper also reflects the behavior of shear walls with overturning restraint (tie-downs or similar) provided at each end as is common in an engineered structure; laboratory testing of shear walls without overturning restraint has shown increases in deflection and reductions in strength (CUREE, 2004; Dolan and Heine, 1997a and 1997b).

EFFECTS OF WALL FINISH MATERIALS

The effect of wall finish materials (gypsum wallboard, exterior stucco or siding, etc) on seismic performance varies with the seismic demand level. The shake table testing of a full-scale townhouse building as part of the NEESWood benchmark (Christovasilis et al., 2007) testing showed a significant influence of finish materials at a ground motion level of roughly 50 percent of the DBE, with resulting average interstory drift of approximately 0.75 percent. It is anticipated that the influence of finish materials will be somewhat less for the full DBE with anticipated interstory drifts on the order of 3 to 4 percent. For structures near collapse, estimated at approximately 7 percent interstory drift based on structures tested on Japan's E-Defense table, it is thought that there is little contribution of finish materials left in the structure. Nonetheless, the inclusion of finish materials in analytical studies for FEMA P695 (ATC, 2008) did improve the collapse margin to an acceptable level so wall finish materials can improve performance. More study of the influence of finish materials is needed.

The NEESWood benchmark testing showed that the reduction of drift due to finish materials was greatest for gypsum wallboard applied to walls detailed as shear walls (i.e., there was positive force transfer between the wall and the diaphragm and overturning restraint was provided). When gypsum wallboard was applied to nonstructural partition walls not detailed for force transfer from the diaphragms, the contribution was minimal. Several studies have also shown that stucco can be very effective in reducing interstory drift demand whereas the NEESWood benchmark testing showed only a modest effect from the stucco exterior finish.

When considering stucco as part of the seismic-force-resisting system, there are several limiting issues. There is concern over the long-term performance of the stucco since stucco in combination with building paper/barriers is the weather barrier for the structure. Staples often are used to attach the lath to the studs, but staple legs do not have much thickness to resist long-term corrosion. Galvanized or stainless steel staples would be more resistant to corrosion.

Finish materials such as gypsum wallboard and stucco have much lower displacement at peak capacity (around 0.5 to 1 percent of the story height) than the more ductile wood structural panel elements (1.5 to 5 percent of the story height). This prevents a simple summation of capacities and complicates estimated performance. Although not directly considered in the design, it seems clear that when a building is responding with interstory drifts on the order of 2 to 3 percent, well beyond the peak capacity of the gypsum or stucco, those elements can provide important hysteretic damping to help attenuate the movement of the structure. Similarly, CUREE shake table tests of a two-story wood-frame house examined the effects of fully sheathed walls (extra sheathing used in a segmented shear wall design above and below the openings). The shake table tests of segmented walls without the horizontal segments had increased wall displacements by a factor of more than two, suggesting that the sheathing above the below the openings has a significant effect on the performance of the structure (CUREE, 2001b).

While not directly addressed in the *International Building Code* (IBC), the effect of finishes can be considered qualitatively. In contrast to moment frame construction, the mode shape of traditional light-frame multistory buildings tends to degrade to a single-degree-of-freedom system as a story reaches its ultimate strength and deforms predominately in shear. As a result, the majority of the displacement demand of the structure is concentrated in the weakest story. The other stories tend to remain in the elastic range. Finishes, which tend to be more concentrated in upper stories, contribute to this behavior and tend to cause significant displacement demand in the first story. Detailing of shear wall boundary members and anchorage connections is vital to adequate seismic performance of the soft or weak story of a structure.

ANALYTICAL MODELING

In order to evaluate the distribution of design forces and drifts, a building analytical model in accordance with ASCE/SEI 7 Section 12.7.3, is needed. Generally, the analysis uses either the simplified alternative structural design criteria (ASCE/SEI 7, Section 12.14) or equivalent lateral force procedure (ASCE/SEI 7, Section 12.8). The primary analysis model includes only those elements designated as structural shear walls and diaphragms.

Vertical distribution of forces should be in accordance with ASCE/SEI 7, which dictates a triangular (first mode) distribution for buildings under the equivalent lateral force procedure and a rectangular distribution with a slight increase in base shear under the simplified alternative structural design criteria.

Analytical modeling of the horizontal distribution of seismic forces at a theoretical level is based on the relative stiffness of the diaphragms, shear walls, and any other force resisting elements. Horizontal distribution should be in accordance with three categories identified in ASCE/SEI 7: diaphragms that are clearly very flexible relative to the vertical elements, diaphragms that are clearly very rigid relative to the vertical elements, and everything else. For “everything else,” it is required that a semi-rigid diaphragm model be used for distribution of horizontal seismic forces.

ASCE/SEI 7 includes an exception permitting one- and two-family residential buildings with diaphragms of wood structural panel or untopped steel decking to be categorized as flexible. The simplified alternative structural design criteria of ASCE/SEI 7, Section 12.14, also permits assumption of a flexible diaphragm force distribution for wood structural panel diaphragms, untopped steel decking, or similar panelized construction (Section 12.4.5) with a small increase in base shear for multistory buildings.

Other buildings braced by wood and CFS light-frame shear walls fall into the “everything else” category. For these other buildings, one approach to meeting this requirement is evaluating force distribution using both rigid and flexible diaphragm models and designing each shear wall and diaphragm for the worst case force. For this approach, the flexible diaphragm model should be solved first, followed by an iterative rigid diaphragm distribution analysis.

Where nonuniform distribution of finish materials might trigger significant torsional behavior in the structure, additional analytical study including the effects of finish materials should be considered.

ADHESIVE ATTACHMENT OF SHEATHING IN WOOD AND CFS LIGHT-FRAME BUILDINGS

Ductility in wood-frame shear walls with wood structural panel sheathing is provided by the fasteners used to attach the sheathing to the framing members. Testing has shown brittle failure when adhesives are used for this attachment in place of mechanical fasteners. This is discussed further in *Recommended Lateral Force Requirements and Commentary* (SEAOC, 1999), Section C804.3. For this reason, the 2006 edition of IBC Section 2305.3.10 states: “Adhesive attachment of shear wall sheathing is not permitted as a substitute for mechanical fasteners, and shall not be used in shear wall strength calculations alone, or in combination with mechanical fasteners in Seismic Design Category D, E or F.” The 2005 edition of AF&PA *Special Design Provisions for Wind and Seismic* (SDPWS) Section 4.3.6.3.1 states: “Adhesive attachment of shear wall sheathing shall not be used alone, or in combination with mechanical fasteners.” Both of these provisions address adhesive attachment in wood-frame shear walls.

To date, adhesives are not known to have been used for structural attachment of wood structural panel sheathing to CFS stud walls. There is no discussion of adhesive attachment of CFS frame shear walls as of yet in either the IBC or AISI S213 (2007); however, a commentary note was added to AISI S213. Limited testing to date (Serrette, 2006) suggests some similarities to the brittle behavior seen in wood-frame shear walls with adhesives. For this reason, adhesive attachment to CFS studs should not be undertaken without adequate study of seismic behavior.

SHEATHING FASTENERS FOR WOOD AND CFS LIGHT-FRAME BUILDINGS

Overdriven Fasteners. Fasteners that are driven past the top of the sheathing have reduced bearing area on the sheathing. Consequently, this can lead to a shear load reduction of sheathed assemblies. APA Technical Note TT-012 states that no reduction is required for wood-sheathed shear walls or diaphragms when the fasteners are overdriven up to 1/16 in. under dry conditions. In addition, no reduction is necessary if no more than 20 percent of the perimeter fasteners are driven between 1/16 and up to 1/8 inch. Also, an article entitled “Capacity of Oriented Strand Board Shear Walls with Overdriven Sheathing Nails” reports on a testing program of overdriven oriented strand board (OSB) sheathing fasteners (Jones and Fonseca, 2002). The 2001 Canadian code, CSA O86 Cl. 9.5.3.4 states: “Nails shall be firmly driven into framing members but shall not be over-driven into sheathing. For structural wood-based sheathing, nails shall not be over-driven more than 15 percent of the panel thickness.”

Significant reductions in strength have been observed in laboratory tests of CFS frame shear wall assemblies when the screw sheathing fasteners are overdriven. This may be due to the countersunk screw head removing or damaging more of the wood sheathing than an overdriven common sheathing nail. Additional testing is required to determine what effect overdriven screw fasteners may have on shear strength for CFS frame shear wall assemblies.

Fastener Locations. The location of the sheathing fasteners affects the performance of shear wall assemblies. If the sheathing fasteners are located too close to the panel edge, they may pull through the sheathing panel before the shear wall assembly reaches its expected capacity. In addition, if the fasteners penetrate into the framing member too close to the

framing member's edge or if the fasteners are spaced too close together, they may cause the wood framing member to split before the assembly obtains the expected load.

Wood Framing Considerations. The AF&PA NDS Commentary (American Forest and Paper Association, 2005b) includes spacing and edge distance recommendations for fasteners less than ¼ in. diameter used for wood framing. In addition, IBC Section 2305.1.2.1 (ICC 2006) and SDPWS Section 4.3.7 require that fasteners not be placed less than 3/8 in. from the panel edge. The IBC and AF&PA SDPWS wood-frame shear wall table require a minimum of a 3 in. nominal framing member at abutting panel edges and staggered placement of fasteners when fasteners are spaced at 2½ in. on center or closer or for 3 in. on center spacing when 10d commons penetrate in the framing members more than 1½ in.

CFS Framing Considerations. AISI S100 (American Iron and Steel Institute, 2007b) includes spacing and edge distance requirements for fasteners used for steel-to-steel connections. AISI S213, Section C2.2, requires that fasteners be 3/8 in. from the panel edge for all of the sheathing panels shown in the standard. The 2007 edition of AISI S21 incorporates a Canadian provision requiring minimum of ½ in. edge distance for wood-sheathed CFS frame shear wall assemblies based on edge distance used in the testing.

Salenikovich (2000) tested walls with different edge distances for the sheathing fasteners and found that the strength/capacity does not increase very much with increased edge distance, but the displacement capacity significantly increased and the building as a whole is toughened (displacement and load cycling ability). The edge distance of the fasteners along the bottom of the wall (between the sheathing and the bottom plate of the wall framing) is especially important to achieve the toughening effect.

HOLD-DOWN CONNECTOR SLIP FOR WOOD AND CFS LIGHT-FRAME BUILDINGS

The aspect ratio of the shear wall affects how much horizontal wall drift is due to vertical deflection of the hold-down connection. Higher aspect ratio shear wall assemblies are more sensitive to hold-down connection slip or deformation. This slip/deformation-related drift is addressed in one part of the light-frame shear wall deflection equation that determines the horizontal wall drift due to the vertical deflection of the hold-down connection. Hold-down deflection may be comprised of fastener slip, device elongation/movement, and/or anchor bolt elongation.

COMBINATION OF MATERIALS FOR WOOD AND CFS LIGHT-FRAME BUILDINGS

Combining shear walls that have different sheathing materials is not permitted by either the IBC or ASCE/SEI 7. It is permitted to have one side opposite the wood sheathed side to be sheathed with gypsum board, and there are load values for that combination of sheathing materials on opposite sides of the same shear wall assembly. This prohibition is due to the difference in stiffness, strength, and performance of shear walls with different sheathing materials that, when combined, may result in unexpected load distribution and failure. However, if the gypsum is to be used to resist the lateral forces in the design, the walls included in the design must have the gypsum attached to the top and bottom plates of the wall framing. This is not the typical attachment used by most drywall installers. The concept of floating corners has been recommended by most drywall manufacturers to prevent cracking of the taped drywall wall-to-ceiling joint. If floating corners are used, the gypsum is totally ineffective in resisting any lateral loads unless the wall deformation causes the gypsum panel to bear on an adjacent structural element (e.g., in a corner).

ASPECT RATIO FOR WOOD AND CFS LIGHT-FRAME BUILDINGS

Shear wall aspect ratio also plays a role in the performance of light-frame shear wall assemblies. Although similar strength may be observed for shear walls of different aspect ratios, with ratios over 2:1 flexural bending of the wall becomes more dominant than shear/fastener deformation. Testing showed that these high aspect ratio walls are more flexible and will not satisfy the required seismic drift limit performance objective without a reduction in design capacity and corresponding design level drift. Therefore, a reduction factor, $2w/h$, was implemented in the AF&PA standard for those shear wall assemblies exceeding 2:1 but not exceeding 3.5:1. The same reduction is applied in the AISI standard for shear wall assemblies with aspect ratios not exceeding 4:1. Also, it should be noted that as walls get narrower, it is crucial to ensure proper installation of the shear wall components (e.g., hold-down connections) since poor installation will lower the performance significantly more (i.e., excessive top of wall drift) than would be seen by a lower aspect ratio wall.

WOOD MOISTURE ISSUES

Significant changes in moisture content (> 8 percent) can affect physical wood properties by swelling or shrinking wood fibers which, in turn, can affect wood connections. Testing by APA shows that wood-frame shear walls do not lose capacity due to moisture changes; however, nail slip is increased and, thus, shear wall deflections increase (APA, 2002). To minimize any negative effects of increased shear wall deflections, the designer should specify dry lumber or engineered wood products (which are typically dry) for optimized structures.

WOOD FRAMING FORCES AND CONNECTIVITY

Tension Failures of Wood Posts. It is unusual for tension posts in walls to fail in tension if the only tension force is the induced force associated with the racking and overturning of the wall segment itself. However, if the load path from upper stories causes significant additional tension forces in the post, failure can occur through three possible mechanisms: net section failure, combined bending and tension failure, and connection failure. Tension posts should be designed with checks for all three failure mechanisms.

Compression Failure of Wood Posts. Compression failures in wood posts are typically associated with high compression load due to accumulation of load due to load path considerations. The possible failure mechanisms are: traditional buckling and beam-column action.

Buckling of the post is usually restricted to the out-of-plane direction of the wall because of the continuous support provided by the sheathing in the plane of the wall. The designer must account for the entire load being supplied to the compression post including the compression induced by the racking and overturning of the wall element itself plus the compression forces being transferred to the post by the stories above and any headers attached to the post. Buckling of isolated, stand-alone posts must be checked in both directions.

Weak Axis Bending of Wood Studs. Shear failures in studs have been observed in wall tests and field studies where strong sheathing materials (e.g., stucco) fail at connections along the bottom of the wall. This causes the next row of fasteners from the bottom of the wall to transfer all of the lateral loads into the studs, thus loading the studs in bending about their weak axis. Typically, the failure occurs at about $1/3$ the height of the stud.

Wood Cross-Grain Bending. Cross-grain bending of wood members leads to failure at relatively low loads. Of particular concern are locations where ledger boards are loaded perpendicular to their length and at shear wall foundation sill plates. For ledgers, the connection between the diaphragm and the masonry or concrete wall should connect the longitudinal diaphragm framing member (or a series of blocked joists) directly to the wall rather than to the ledger. In shear walls, wide steel plate washers and stiff hold-down connectors or straps should be used to reduce the cross-grain bending action.

Bearing Failure of Wood Plate. The failure of the bottom plate of the wall due to compression perpendicular to grain causes damage to the wood member holding sheathing fasteners along the bottom of the wall. Added deformation of walls with wood framing loaded perpendicular to grain at wood floor levels compared to walls located on slabs-on-grade has been observed in testing and should be accounted for in analysis of drift. Guidance on this effect needs to be developed.

Sheathing Connectors to Wood Studs. The primary source of drift and energy dissipation of wood-frame shear walls is the bending and yielding of the shear wall sheathing to framing fasteners around the perimeter of each sheathing panel accompanied by slip between the sheathing and framing. In most wood-frame shear walls, the racking of the wall causes yielding of sheathing to framing fasteners along with local crushing of the framing and sheathing due to fastener bearing. Other common sheathing fastener behaviors include nail heads pulled through the sheathing and withdrawal of the nail from the framing member. A less desirable behavior is the tear-out of the fastener through the edge of the sheathing; increasing the edge distance from the center of the fastener to the edge of the sheathing panel to not less than $1/2$ in. can help to reduce the occurrence of this behavior.

COLD-FORMED STEEL MEMBER CONSIDERATIONS

Local Damage of Framing. The thin-walled nature (i.e., small thickness) of CFS framing members makes them vulnerable to physical damage that may have an adverse effect on the structural performance (AISI S200-07). Full damage assessment is not within the scope of the AISI standards and, consequently, when damage alters the cross-section geometry of a framing member beyond the specified tolerances, the designer should be consulted (American Iron and Steel Institute, 2007c).

Web Holes. As with any material, large holes may affect the structural performance of CFS framing members. Therefore, CFS framing standards (AISI S200-07) require that: "Holes in webs of studs, joists and tracks shall be in conformance with

an approved design, AISI S100, or an approved design standard. Webs with holes not conforming to the above shall be reinforced or patched in accordance with an approved design or approved design standard.”

In CFS framing members, a “punchout” is defined as a hole made during the manufacturing process in the web of a steel framing member (AISI S200-07). Suitable dimensions and locations of standard punchouts are further defined (AISI S201-07; AISI, 2007d).

Nominal shear strengths for shear walls that have been included in industry design standards are based on tests with studs with 1.5-in. (38 mm) x 4-in. (100 mm) punch outs at a center-to-center spacing of 24 inches (600 mm) and, as a result, the use of studs with standard punch outs is permitted when using these values (AISI S213-07).

Local Buckling of CFS Framing Members. CFS framing members are susceptible to local buckling when loaded in compression. Consequently, local buckling is a necessary design consideration for CFS members. To that end, CFS framing standards (AISI S213-07) specify that: “The proportioning, design and detailing of cold-formed steel light-frame systems, members, connections and connectors ... be in accordance with AISI S100.”

AISI S100-07 considers local buckling of individual elements of CFS members as a major design criterion. As such, AISI S100-07 requires that the design of such members provide sufficient safety against the failure mode with due consideration to post-buckling strength. Post-buckling strength of plate elements was identified experimentally in 1928. In order to utilize the post-buckling strength for design purposes, AISI has used the effective design width approach to determine the section properties since 1946.

The designer should pay particular attention to the buckling performance for collectors and headers that are acting as drag struts. These members can have relatively high compression forces and must be designed for cyclic loading. The local transfer of forces into wall or diaphragm elements also becomes an area where localized buckling can occur.

Bending Failure of CFS Framing Members. The difference in local buckling behavior between stiffened and unstiffened elements results in a significant difference in the weak axis bending strength between stud and track members. Weak axis bending strength of a track member is typically lower than that of a stud. This makes proper design and detailing of wall anchorage important in order to minimize bending loads on track members. Connection of the anchorage device directly to the chord stud is a common detail that effectively eliminates bending loads on track members.

Bending Deformation of CFS Track Web. CFS framing members offer limited strength and stiffness to resist transverse concentrated loads such as would be applied by an anchor bolt with standard cut washer through the track web if used to resist wall uplift forces. This is similar to the concern regarding cross grain bending in a wood bottom plate with a similar anchorage detail.

Consequently, the AISI CFS framing standards (AISI S213-07) require that: “Studs or other vertical boundary members at the ends of wall segments, that resist seismic loads, braced with either sheathing or diagonal braces, ... be anchored such that the bottom track is not required to resist uplift by bending of the track web.”

Connection of the anchorage device directly to the chord stud is the most common detail that effectively eliminates transverse concentrated loads on track members. Use of a C-shape section (i.e., stud) reinforcement or a plate washer at anchor bolts are other ways to distribute transverse concentrated loads that may avoid this problem.

CFS Sheathing Connectors. As with wood-frame shear walls, in CFS shear walls inelastic behavior is primarily concentrated at the fasteners connecting the sheathing to the wall-framing members. However, the behavior of sheathing screw fasteners in CFS framing members is different from the behavior of sheathing nails in wood framing.

Nguyen et al. (1996) report: “In general, racking of the wall resulted in the screw fasteners rocking (tilting) about the plane of the stud flange material immediately around the screw. This behavior resulted in permanent lateral deflection of the wall and appears to be the main source of energy dissipation in the walls. As the lateral displacement of the wall increased, the panel pulled over the screw heads and became unzipped.”

Screw size must be sufficient to preclude the screw shear failure mode. Thus, the screw size needs to be properly matched with framing member thickness to assure the desired behavior. The AISI CFS framing standards (AISI S213-07) require that: “Unless noted as (min.), substitution of a stud or track of a different designation thickness is not permitted.”

For CFS framing, AISI S200-07 indicates: “Ends of structural wall studs shall have square end cuts and shall be seated tight against the tracks. For the purpose of this section, seated tight shall mean that a maximum gap tolerance of 1/8 inch (3.2 mm) will be acceptable between the end of wall framing member and the track.” The CFS framing end gap does not adversely affect strength, but it is likely to contribute to system flexibility and shear wall deflection.

Testing has shown that a smaller gap tolerance may be suitable in some situations. For instance, testing of thicker materials (greater than 0.054 in.) showed that “the relative movement between the stud and track could result in shear failure of the screws.” In these cases, a smaller gap tolerance of 1/16 in. (1.6 mm) may be more appropriate. AISI S200-07 further indicates: “a smaller gap tolerance may also be desirable in multi-story structures where the accumulation of these gap closures may become significant. Depending on track radius, it may be necessary to oversize the depth of the track to assure that the stud flanges do not prematurely engage the track radius and result in an excessive gap.”

The designer should take the above into consideration when calculating shear wall deflections by considering the effect of the end gap in the fourth term of the deflection equation (i.e., lateral contribution from anchorage/hold-down deformation)(AISI S213-07).

Pull-Out Resistance of CFS Screw Fasteners. The pull-out resistance of screw fasteners may be reduced when the fasteners are cyclically loaded (Mahendran and Maharaachchi, 2000). Consequently, CFS framing standards (AISI S213-07) require that: “The pull-out resistance of screws ... not be used to resist seismic forces.”

REFERENCES

- American Forest and Paper Association. 2005a. *Special Design Provisions for Wind and Seismic with Commentary* (SDPWS), 2005 edition. AF&PA, Washington, D.C.
- American Forest and Paper Association. 2005b. *National Design Specification for Wood Construction*. AF&PA, Washington, D.C.
- APA-The Engineered Wood Association. 2002. *Effect of green Lumber Framing on Wood Structural Panel Shear Wall Performance*, Report T2002-53. APA, Tacoma, Washington.
- American Iron and Steel Institute. 2007a. *North American Standard for Cold-Formed Steel Framing – Lateral Design*, S213-07. AISI, Washington, D.C.
- American Iron and Steel Institute. 2007b. *North American Specification for the Design of Cold-Formed Steel Structural Members*, S100-07. AISI, Washington, D.C.
- American Iron and Steel Institute. 2007c. *North American Standard for Cold-Formed Steel Framing – General Provisions*, S200-07. AISI, Washington, D.C.
- American Iron and Steel Institute. 2007d. *North American Standard for Cold-Formed Steel Framing – Product Data*, S201-07, AISI S201-07. AISI, Washington, D.C.
- American Society of Civil Engineers. 2005. *Minimum Design Loads for Buildings and Other Structures*, ASCE/SEI 7-05. ASCE, Reston, Virginia.
- Applied Technology Council. 2008. *Recommended Methodology for Quantification of Building System Performance and Response Parameters*: ATC 63 90 percent draft, FEMA P695. Federal Emergency Management Agency, Washington, D.C.
- Building Seismic Safety Council. 2003. *NEHRP Recommended Provisions for Seismic Regulations for New Buildings and Other Structures*, FEMA 450. Federal Emergency Management Agency, Washington, DC.
- Cecotti, A., and E. Karacabeyli. 2002. “Validation of Seismic Design Parameters for Wood-frame Shearwall Systems,” *Canadian Journal of Civil Engineering*, 29: 484-498. National Research Council, Ottawa, Canada.
- Christovasilis, I. P., A. Filiatrault, and A. Wanitkorkul. 2007. *Seismic Testing of a Full-Scale Two-Story Light-Fame Building: NEESWood Benchmark Test*, Report NW-01. Prepared as part of the NEESWood Project, Development of a Performance-Based Seismic Design Philosophy for Mid-Rise Woodframe Construction, www.engr.colostate.edu/NEESWood.
- Canadian Standards Association. 2001. *Engineering Design in Wood*, CAN/CSA-O86. Canadian Standards Association, Mississauga, Ontario, Canada.
- Consortium of Universities for Research in Earthquake Engineering. 2001a. *Woodframe Project Case Studies*, CUREE W-04. CUREE, Richmond, California.
- Consortium of Universities for Research in Earthquake Engineering. 2001b. *Shake Table Tests of a Two-Story Woodframe House*, CUREE W-06. CUREE, Richmond, California.

- Consortium of Universities for Research in Earthquake Engineering. 2002a. *Northridge Earthquake Field Investigations: Statistical Analysis of Woodframe Damage*, CUREE W-09. CUREE, Richmond, California.
- Consortium of Universities for Research in Earthquake Engineering. 2002b. *Seismic Modeling of Woodframe Index Buildings*, CUREE W-12. CUREE, Richmond, California.
- Consortium of Universities for Research in Earthquake Engineering. 2002c. *Seismic Evaluation on an Asymmetric Three-Story Woodframe Buildings*, CUREE W-19. CUREE, Richmond, California.
- Consortium of Universities for Research in Earthquake Engineering. 2004. *Recommendations for Earthquake Resistance in the Design and Construction of Woodframe Buildings*, CUREE W-30. CUREE, Richmond, California.
- Dolan, J. D., and C. P. Heine. 1997a. *Monotonic Tests of Wood-frame Shear Walls with Various Openings and Base Restraint Configurations*, Timber Engineering Center Report TE-1997-001. Virginia Polytechnic Institute and State University, Blacksburg.
- Dolan, J. D., and C. P. Heine. 1997b. *Sequential Phased Displacement Cyclic Tests of Wood-frame Shear Walls with Various Openings and Base Restraint Configurations*, Timber Engineering Center Report TE-1997-002. Virginia Polytechnic Institute and State University, Blacksburg.
- International Code Council. 2006. *International Building Code (IBC)*, 2006 edition. ICC, Country Club Hills, Illinois.
- Jones, Scott N., and Fernando S. Fonesca. 2002. "Capacity of Oriented Strand Board Shear Walls with Overdriven Sheathing Nails," *ASCE/SEI Journal of Structural Engineering*, 128(7)..
- Mahendran, M., and D. Maharaachchi. 2000. "Cyclic Pull-out Strength of Steel Roof and Wall Cladding Systems" in *Proceedings of the 15th International Specialty Conference on Cold-Formed Steel Structures*, Department of Civil Engineering University of Missouri-Rolla, Rolla.
- Nguyen Hoang, Georg Hall, and Reynaud Serrette. 1996. *Shear Wall Values for Lightweight Steel Framing*. Santa Clara University, Santa Clara, California.
- Pryor, S., G. Taylor, and C. Ventura. 2000. "Seismic Testing and Analysis Program on High Aspect Ratio Wood Shear Walls" in *International Timber Engineering Conference 2000*, Whistler, British Columbia, Canada.
- Structural Engineers Association of California. 1999. *Recommended Lateral Force Requirements and Commentary*. SEAOC, Sacramento, California.
- Serrette, Reynaud. 2006. "Cold-Formed Steel Frame Shear Walls Utilizing Structural Adhesives," *ASCE/SEI Journal of Structural Engineering*.
- Salenikovich, A. 2000. The Racking Performance of Light-Frame Shear Walls, dissertation submitted as partial fulfillment of the requirements for Ph.D. at Virginia Tech, Blacksburg.

Appendix

2009 NEHRP RECOMMENDED SEISMIC PROVISIONS PROJECT PARTICIPANTS

2008-2009 BSSC BOARD OF DIRECTION

Chair

David R. Bonneville, PE, SE, Degenkolb Engineers, San Francisco, California

Vice Chair

Position vacant

Secretary

James Rinner, J. E. Dunn Construction Company, Topeka, Kansas (representing the Associated General Contractors of America)

Ex Officio

Jim. W. Sealy, FAIA, Architect/Consultant, Dallas, Texas

Members

Edwin Dean, PE, SE, Nishkian Dean, Portland, Oregon (representing the Applied Technology Council)

Cynthia J. Duncan, American Institute of Steel Construction, Chicago, Illinois

Jay W. Larson, PE, FASCE, American Iron and Steel Institute, Bethlehem, Pennsylvania

Joseph Messersmith, Portland Cement Association, Rockville, Virginia

Ronald E. Piester, RA, New York State Department, Division of Code Enforcement and Administration (representing the International Code Council)

Timothy Reinhold, Institute for Building and Home Safety, Tampa, Florida

James Rossberg, PE, American Society of Civil Engineers, Reston, Virginia

James "Tim" Ryan, CBO, City of Overland Park, Kansas (representing the National Institute of Building Sciences)

Gregory Schindler, PE, SE, KPFF Consulting Engineers, Seattle, Washington (representing the National Council of Structural Engineers Associations)

Charles Spitz, NCARB, AIA, CSI, Architect/Planner Code Consultant, Wall, New Jersey (representing the American Institute of Architects)

S. Shyam Sunder, National Institute of Standards and Technology, Gaithersburg, Maryland (representing the Interagency Committee for Seismic Safety in Construction)

Robert D. Thomas, National Concrete Masonry Association, Herndon, Virginia

David P. Tyree, PE, CBO, American Forest and Paper Association, Colorado Springs, Colorado

2007-2008 BSSC BOARD OF DIRECTION

Chair

Henry Green, Bureau of Construction Codes, State of Michigan Department of Consumer and Industry Services, Okemos, Michigan

Vice Chair

David R. Bonneville, PE, SE, Degenkolb Engineers, San Francisco (representing the Earthquake Engineering Research Institute)

Secretary

James Rinner, Kitchell CEM, Sacramento, California (representing the Associated General Contractors of America)

Ex Officio

Jim. W. Sealy, FAIA, Architect/Consultant, Dallas, Texas

Members

Bradford K. Douglas, PE, American Forest and Paper Association, Washington, DC

Edwin Dean, PE, SE, Nishkian Dean, Portland, Oregon (representing the Applied Technology Council)

Cynthia J. Duncan, American Institute of Steel Construction, Chicago, Illinois

Jay W. Larson, PE, FASCE, American Iron and Steel Institute, Bethlehem, Pennsylvania

Joseph Messersmith, Portland Cement Association, Rockville, Virginia

Ronald E. Piester, RA, New York State Department, Division of Code Enforcement and Administration (representing the International Code Council)

Timothy Reinhold, Institute for Building and Home Safety, Tampa, Florida

James Rossberg, PE, American Society of Civil Engineers, Reston, Virginia

Howard Simpson, ScD, PE, Simpson, Gumpertz and Heger, Arlington, Massachusetts (representing the National Council of Structural Engineers Associations)

Charles Spitz, NCARB, AIA, CSI, Architect/Planner Code Consultant, Wall, New Jersey (representing the American Institute of Architects)

S. Shyam Sunder, National Institute of Standards and Technology, Gaithersburg, Maryland (representing the Interagency Committee for Seismic Safety in Construction)

Robert D. Thomas, National Concrete Masonry Association, Herndon, Virginia

2006-2007 BSSC BOARD OF DIRECTION

Chair

Jim W. Sealy, FAIA, Architect/Consultant, Dallas, Texas

Vice Chair

David R. Bonneville, PE, SE, Degenkolb Engineers, San Francisco (representing the Earthquake Engineering Research Institute)

Secretary

James Rinner, Kitchell CEM, Sacramento, California (representing the Associated General Contractors of America)

Ex Officio

Charles H. Thornton, PhD, SE, Thornton-Tomasetti Group, Inc., Washington, DC

Members

Bradford K. Douglas, PE, American Forest and Paper Association, Washington, DC

Edwin Dean, PE, SE, Nishkian Dean, Portland, Oregon (representing the Applied Technology Council)

Cynthia J. Duncan, American Institute of Steel Construction, Chicago, Illinois

Henry Green, Bureau of Construction Codes, State of Michigan Department of Consumer and Industry Services, Okemos, Michigan (representing the National Institute of Building Sciences)

Jay W. Larson, PE, FASCE, American Iron and Steel Institute, Bethlehem, Pennsylvania

Joseph Messersmith, Portland Cement Association, Rockville, Virginia

Ronald E. Piester, RA, New York State Department, Division of Code Enforcement and Administration (representing the International Code Council)

Timothy Reinhold, Institute for Building and Home Safety, Tampa, Florida

James Rossberg, PE, American Society of Civil Engineers, Reston, Virginia

Howard Simpson, ScD, PE, Simpson, Gumpertz and Heger, Arlington, Massachusetts (representing the National Council of Structural Engineers Associations)

Charles Spitz, NCARB, AIA, CSI, Architect/Planner Code Consultant, Wall, New Jersey (representing the American Institute of Architects)

S. Shyam Sunder, National Institute of Standards and Technology, Gaithersburg, Maryland (representing the Interagency Committee for Seismic Safety in Construction)

Robert D. Thomas, National Concrete Masonry Association, Herndon, Virginia

2005-2006 BSSC BOARD OF DIRECTION

Chair

Jim W. Sealy, FAIA, Architect/Consultant, Dallas, Texas

Vice Chair

David R. Bonneville, PE, SE, Degenkolb Engineers, San Francisco, California (representing the Earthquake Engineering Research Institute)

Secretary

James Rinner, Turner Construction, Dixon, California (representing the Associated General Contractors of America)

Ex Officio

Charles H. Thornton, PhD, SE, Thornton-Tomasetti Group, Inc., Washington, DC

Members

Bradford K. Douglas, PE, American Forest and Paper Association, Washington, DC

Cynthia J. Duncan, American Institute of Steel Construction, Chicago, Illinois

Edwin Dean, PE, SE, Nishkian Dean, Portland, Oregon (representing the Applied Technology Council)

Henry Green, Bureau of Construction Codes, State of Michigan Department of Consumer and Industry Services, Okemos, Michigan (representing the National Institute of Building Sciences)

Jay W. Larson, PE, FASCE, American Iron and Steel Institute, Bethlehem, Pennsylvania

Joseph Messersmith, Portland Cement Association, Rockville, Virginia

Ronald E. Piester, RA, New York State Department, Division of Code Enforcement and Administration (representing the International Code Council)

Timothy Reinhold, Institute for Building and Home Safety, Tampa, Florida

James Rossberg, PE, American Society of Civil Engineers, Reston, Virginia

Howard Simpson, ScD, PE, Simpson, Gumpertz and Heger, Arlington, Massachusetts (representing the National Council of Structural Engineers Associations)

Charles Spitz, NCARB, AIA, CSI, Architect/Planner Code Consultant, Wall, New Jersey (representing the American Institute of Architects)

S. Shyam Sunder, National Institute of Standards and Technology, Gaithersburg, Maryland (representing the Interagency Committee for Seismic Safety in Construction)

Robert D. Thomas, National Concrete Masonry Association, Herndon, Virginia

2004-2005 BSSC BOARD OF DIRECTION

Chair

Jim W. Sealy, FAIA, Architect/Consultant, Dallas, Texas

Vice Chair

David R. Bonneville, PE, SE, Degenkolb Engineers, San Francisco, California (representing the Earthquake Engineering Research Institute)

Secretary

Jim Rinner, Kitchell CEM, Sacramento, California

Ex Officio

Charles H. Thornton, PhD, SE, Thornton-Tomasetti Group, Inc., Washington, DC

Members

Bradford K. Douglas, PE, American Forest and Paper Association, Washington, DC
Edwin Dean, PE, SE, Nishkian Dean, Portland, Oregon (representing the Applied Technology Council)
Henry Green, Bureau of Construction Codes, State of Michigan Department of Consumer and Industry Services, Okemos, Michigan (representing the National Institute of Building Sciences)
H. S. Lew, PhD, PE, National Institute of Standards and Technology, Gaithersburg, Maryland (representing the Interagency Committee for Seismic Safety in Construction)
Joseph Messersmith, Portland Cement Association, Rockville, Virginia
Ronald E. Piester, RA, New York State Division of Code Enforcement and Administration, Kinderhook, New York (representing the International Code Council)
James Rinner, Turner Construction, Dixon, California (representing the Associated General Contractors of America)
James Rossberg, PE, American Society of Civil Engineers, Reston, Virginia
Jeffrey Sciaudone, PE, Institute for Building and Home Safety, Tampa, Florida
W. Lee Shoemaker, PhD, Metal Building Manufacturers Association, Cleveland, Ohio
Howard Simpson, ScD, PE, Simpson, Gumpertz and Heger, Arlington, Massachusetts (representing the National Council of Structural Engineers Associations)
Charles Spitz, NCARB, AIA, CSI, Architect/Planner Code Consultant, Wall, New Jersey (representing the American Institute of Architects)
Robert D. Thomas, National Concrete Masonry Association, Herndon, Virginia

BSSC MEMBER ORGANIZATIONS

Voting Members

AFL-CIO Building & Construction Trades Department

Representative: Pete Stafford, Center to Protect Worker's Rights

American Concrete Institute

Representative: Shuaib H. Ahmed, American Concrete Institute

American Consulting Engineers Council

Representative: Gregg Brandow, PhD, Brandow & Johnston Assoc.

Alternate: Edward Bajer, American Consulting Engineers Council

American Forest & Paper Association

Representative: Bradford K. Douglas, PE, American Forest & Paper Association

Alternate: Philip Line, PE, American Forest & Paper Association

American Institute of Architects

Representative: Charles A. Spitz, AIA, CSI, NCARB, Architect-Planner-Code Consultant

Alternate: Perry Haviland, FAIA, Haviland Associates Architects

American Institute of Steel Construction

Representative: Cynthia J. Duncan, American Institute of Steel Construction

Alternate: Louis F. Geschwinder, American Institute of Steel Construction

American Iron and Steel Institute

Representative: Bonnie Manley, American Iron & Steel Institute

APA - The Engineered Wood Association

Representative: Thomas D. Skaggs, PhD, APA - The Engineered Wood Association

Alternate: Borjen Yeh, APA - The Engineered Wood Association

American Society of Civil Engineers

Representative: James A. Rossberg, American Society of Civil Engineers

Alternate: Douglas G. Honegger, Consulting Engineer

American Society of Civil Engineers - Kansas City Chapter

Representative: Thomas Heausler, Heausler Structural Engineers

Alternate: F. Alan Wiley, Black & Veatch

American Society of Heating, Refrigerating and Air-Conditioning Engineers, Inc.

Representative: William Staehlin, Division of State Architect (California)

Alternate: Claire Ramspeck, ASHRAE

American Society of Mechanical Engineers

Representative: Ronald W. Haupt, Pressure Piping Engineering Associates

Alternate: Timothy Adams, Stevenson & Associates

American Welding Society

Representative: John Gayler, American Welding Society

Alternate: Andrew Davis, American Welding Society

Applied Technology Council

Representative: Edwin T. Dean, Nishkian Dean

Alternate: Christopher Rojahn, Applied Technology Council

Associated General Contractors of America

Representative: Jim Rinner, J.E. Dunn Construction Company

Alternate: Corey Peterson, Associated General Contractors of Kansas, Inc.

Association of Engineering Geologists

Representative: Ellis Krinitzsky, Army Corps of Engineers

Alternate: Patrick J. Barosh, Patrick J. Barosh & Associates

Association of Major City Building Officials

Representative: Andrew A. Adelman, City of Los Angeles Department of Building & Safety

Alternate: Victor Cuevas, City of Los Angeles Department of Building & Safety

Brick Industry Association

Representative: J. Gregg Borchelt, Brick Industry Association

Alternate: Charles B. Clark, Brick Industry Association

Building Owners and Managers Association International

Representative: Ron Burton, BOMA, International

California Seismic Safety Commission

Representative: Fred Turner, Seismic Safety Commission (California)

Canadian National Committee on Earthquake Engineering

Representative: R. H. Devall, Read Jones Christoffersen, Ltd.

Alternate: Cathleen Taraschuk, National Research Council of Canada

Concrete Masonry Association of California and Nevada

Representative: Kurtis K. Siggard, Concrete Masonry Association of California and Nevada

Alternate: Chukwuma Ekwueme, Weidlinger Associates, Inc.

Concrete Reinforcing Steel Institute

Representative: Scott Humphreys, Concrete Reinforcing Steel Institute

Alternate: Attila Beres, Concrete Reinforcing Steel Institute

Division of the State Architect (California)

Representative: Dennis Bellet, Division of State Architect

Alternate: Howard Smith, Jr., Division of State Architect

Earthquake Engineering Research Institute

Representative: David R. Bonneville, Degenkolb Engineers

Alternate: F. Robert Preece, Consultant

General Services Administration-Seismic Program

Representative: Bela I. Palfalvi, GSA-Seismic Program

Alternate: Catherine K. Lee, GSA-Seismic Program

Hawaii State Earthquake Advisory Board

Representative: Gary Y. K. Chock, Martin & Chock, Inc.

Alternate: Ian Robertson, Hawaii State Earthquake Advisory Committee

Institute for Business and Home Safety

Representative: Timothy A. Reinhold, Institute for Business and Home Safety

Interagency Committee on Seismic Safety in Construction

Representative: Shyam Sunder, National Institute of Standards & Technology

Alternate: H. S. Lew, National Institute of Standards & Technology

International Code Council

Representative: Tom Frost, International Code Council

Alternate: Steve Ikkanda, International Code Council

International Masonry Institute

Representative: Diane Throop, International Masonry Institute

Alternate: Richard Filloramo, International Masonry Institute

Masonry Institute of America

Representative: John Chrysler, Masonry Institute of America

Metal Building Manufacturers Association

Representative: W. Lee Shoemaker, Metal Building Manufacturers Association

Alternate: Scott Russell, Nucor Building systems

Mid-America Earthquake Center

Representative: Amr Elnashai, University of Illinois--MAE Center

National Association of Home Builders

Representative: Gary Ehrlich, National Association of Home Builders

Alternate: Ed Sutton, National Association of Home Builders

National Concrete Masonry Association

Representative: Jason J. Thompson, National Concrete Masonry Association

Alternate: Robert D. Thomas, National Concrete Masonry Association

National Conference of States on Building Codes and Standards

Representative: Richard T. Conrad, AIA, Division of State Architect

Alternate: Robert C. Wible, National Conference of States on Bldg. Codes & Standards

National Council of Structural Engineers Associations

Representative: Kevin Moore, Certus Consulting, Inc.

Alternate: Greg Schindler, KPFF Consulting Engineers

National Elevator Industry, Inc.

Representative: Jean Smith, Schindler Elevator Corporation

Alternate: George A. Kappenhagen, Schindler Elevator Corporation

National Fire Sprinkler Association, Inc.

Representative: Victoria Valentine, National Fire Sprinkler Association

Alternate: Russell P. Fleming, National Fire Sprinkler Association

National Institute of Building Sciences

Representative: Jim W. Sealy, FAIA, Architect/Consultant

Alternate: Gerald H. Jones, Code Official, Retired

National Ready Mixed Concrete Association

Representative: Colin L. Lobo, National Ready Mixed Concrete Association

Portland Cement Association

Representative: Joseph J. Messersmith, Jr., Portland Cement Assoc.

Alternate: S. K. Ghosh, PhD, S. K. Ghosh & Associates, Inc.

PreCast/Prestressed Concrete Institute

Representative: Jason J. Krohn, Precast/Prestressed Concrete Institute

Alternate: David A. Sheppard, D A Sheppard Consulting Structural Engineer, Inc.

Rack Manufacturers Institute

Representative: Victor Azzi, Rack Manufacturers Institute

Alternate: John Nofsinger, Rack Manufacturers Institute

Steel Deck Institute

Representative: Steven A. Roehrig, Steel Deck Institute

Alternate: Walter Schultz, Nucor Research & Development

Structural Engineers Association of California

Representative: Jon P. Kiland, KPW Structural Engineers, Inc.

Alternate: Kevin Moore, Certus Consulting, Inc.

Structural Engineers Association of Central California

Representative: Samantha M. Kersting, Buehler & Buehler Structural Engineers, Inc.

Alternate: Tom H. Hale, California Office of Statewide Health Planning and Development

Structural Engineers Association of Colorado

Representative: James R. Harris, J. R. Harris & Company

Alternate: Dave Houdeshell, JVA Incorporated

Structural Engineers Association of Illinois

Representative: W. Gene Corley, CTL Group

Structural Engineers Association of Kentucky

Representative: Mark A. Caldwell, Apex Engineering, Inc.

Alternate: Chella Subram, Cornerstone Engineering, Inc.

Structural Engineers Association of Northern California

Representative: Jon Kiland, Dasse Design

Structural Engineers Association of Oregon

Representative: Michael Hagerty, City of Portland

Alternate: Joseph Gehlen, Kramer Gehlen Associates

Structural Engineers Association of San Diego

Representative: Geoff Warcholik, KPFF Consulting Engineers, Inc.

Alternate: Chris Kamp, Stedman & Dyson Structural Engineers

Structural Engineers Association of Southern California

Representative: Mehran Pourzanjani, Saiful/Bouquet Structural Engineers

Alternate: Williston L. Warren, SESOL, Inc.

Structural Engineers Association of Texas

Representative: Joseph Kallaby, OSI

Alternate: Michael D. Engelhardt, University of Texas

Structural Engineers Association of Utah

Representative: A. Parry Brown, Reaveley Engineers and Associates

Alternate: David L. Pierson, ARW Engineers

Structural Engineers Association of Washington

Representative: Doug Wilson, Reid Middleton, Inc.

Alternate: Michael Valley, Magnusson Klemencic

The Masonry Society

Representative: Arturo Schultz, University of Minnesota, U.S. Army CERL

Representative: Steven C. Sweeney, U.S. Army CERL (CEERD-CF-M)

Western States Clay Products Association

Representative: Jeff I. Elder, PE, Western States Clay Products Association

Western States Council of Structural Engineers Association

Representative: Greg Shea, Moffatt, Nichol & Bonney, Inc.

Wire Reinforcement Institute, Inc.

Representative: Roy H. Reiterman, PE, WRI Technical Consultant

Alternate: Robert C. Richardson, Consultant

Affiliate Members

Baltimore Aircoil Company

Bay Area Structural, Inc.

Building Technology, Incorporated

CH2M Hill

City of Hayward, California

Felten Engineering Group, Inc.

Flexhead Industries

H&H Group

HLM Design

LaPay Consulting, Inc.

Sea Hawk Enterprises, Inc.

Square D Company

State Farm Insurance Company

Steel Joist Institute

Vibration Mountings and Controls

York, a Johnson Controls Company

FEDERAL EMERGENCY MANAGEMENT AGENCY PROJECT PERSONNEL

Robert D. Hanson, PhD, PE, FEMA Subject Matter Expert, Professor Emeritus, University of Michigan, Walnut Creek, California

Michael Mahoney, Geophysicist, FEMA Mitigation Directorate, Risk Reduction Division, Building Science Branch, Washington, DC

Mai (Mike) Tong, PhD, Physical Scientist, FEMA Mitigation Directorate, Risk Reduction Division, Building Science Branch, Washington, DC

NATIONAL EARTHQUAKE HAZARDS REDUCTION PROGRAM LIAISON

John (Jack) R. Hayes, Director, NEHRP, National Institute of Standards and Technology, Gaithersburg, Maryland

**NATIONAL INSTITUTE OF BUILDING SCIENCES/BUILDING SEISMIC SAFETY
COUNCIL STAFF**

Claret M. Heider, NIBS Vice President for Building Seismic Safety Council and Multihazard Mitigation Council Programs

Bernard Murphy, PE, Director, Special Projects

Carita Tanner, Communications Director

Joanette Parker, Administrative Assistant

2009 PROVISIONS UPDATE COMMITTEE

Chair

Ronald O. Hamburger, Senior Principal, Simpson Gumpertz and Heger, San Francisco, California

Ex Officio Voting Member

William Holmes, Vice President, Rutherford and Chekene Engineers, San Francisco, California

Representing Technical Subcommittee 1, Document Composition and Management

William Holmes, Vice President, Rutherford and Chekene Engineers, Oakland, California

John D. Gillengerten, Deputy Director, Office of Statewide Health and Planning and Development, Sacramento, California

Ronald O. Hamburger, Senior Principal, Simpson Gumpertz and Heger, San Francisco, California

James R. Harris, President, J. R. Harris and Company, Denver, Colorado

John D. Hooper, Director of Earthquake Engineering, Magnusson Klemencic, Seattle, Washington

E. V. Leyendecker, Research Civil Engineer, U.S. Geological Survey, Denver, Colorado

Representing Technical Subcommittee 2, Design Criteria and Analysis and Advanced Technologies

John D. Hooper, Director of Earthquake Engineering, Magnusson Klemencic, Seattle, Washington

Mark Aschheim, Professor, Santa Clara University, California

James R. Harris, President, J. R. Harris and Company, Denver, Colorado

Charles Kircher, Principal, Charles Kircher and Associates Consulting Engineers, Palo Alto, California

Representing Technical Subcommittee 3, Mapping, Foundations and Geotechnical Considerations

C. B. Crouse, Principal Engineer, URS Corporation, Seattle, Washington

Roger Borchardt, Research Engineering Seismologist, U.S. Geological Survey, Menlo Park, California

E. V. Leyendecker, Research Civil Engineer, U.S. Geological Survey, Denver, Colorado

Jonathan P. Stewart, Professor, University of California, Los Angeles

Representing Technical Subcommittee 4, Concrete Structures

Neil Hawkins, Professor Emeritus, University of Illinois, Clyde Hill, Washington

S. K. Ghosh, Principal, S. K. Ghosh Associates, Palatine, Illinois

Sharon L. Wood, Professor of Civil Engineering, University of Texas, Austin

Representing Technical Subcommittee 5, Masonry Structures

Richard E. Klingner, Professor, University of Texas, Austin

Thomas A. Gangel, Principal, Wallace Engineering Structural Consultants, Tulsa, Oklahoma

Jason J. Thompson, Structural Engineer, National Concrete Masonry Association, Herndon, Virginia

Representing Technical Subcommittee 6, Steel and Composite Steel and Concrete Structures

James O. Malley, Senior Principal, Degenkolb Engineers, San Francisco, California

Roberto T. Leon, Professor, School of Civil and Environmental Engineering, Georgia Institute of Technology, Atlanta, Georgia

Bonnie Manley, Regional Director American Iron and Steel Institute, Norfolk, Massachusetts

Representing Technical Subcommittee 7, Wood Structures

Kelly Cobeen, Associate Principal, Wiss, Janney, Elstner Associates, Emeryville, California

J. Daniel Dolan, Professor, Washington State University, Pullman, Washington

Philip Line, Manager, Engineering Research, American Forest and Paper Association, Washington, DC

Representing Technical Subcommittee 8, Nonstructural Components and Nonbuilding Structures

J. G. (Greg) Soules, Principal Engineer, Chicago Bridge and Iron, The Woodlands, Texas

John D. Gillengerten, Deputy Director, Office of Statewide Health and Planning and Development, Sacramento, California

Harold Sprague, Structural Project Engineer, Black and Veatch Special Projects Corporation, Overland Park, Kansas

Representing Issue Team 1, Performance Criteria

William Holmes, Vice President, Rutherford and Chekene Engineers, Oakland, California

Representing Issue Team 2, Design Parameters

Robert E. Bachman, Principal, RE Bachman Consulting Engineers, Laguna Niguel, California

C. Mark Saunders, President, Rutherford and Chekene Consulting Engineers, San Francisco, California

Representing Issue Team 3, Foundation Design Requirements

Martin Johnson, Director ELSR Division, ABS Consulting, Irvine, California

Seismic Design Procedures Review Group

Charles Kircher, Principal, Charles Kircher and Associates Consulting Engineers, Palo Alto, California

PROVISIONS UPDATE PROJECT WORKING GROUPS

Technical Subcommittee 1, Document Composition and Management

Chair

William Holmes, Vice President, Rutherford and Chekene Engineers, San Francisco, California

Members

John D. Gillengerten, Deputy Director, Office of Statewide Health and Planning and Development, Sacramento, California

Ronald O. Hamburger, Structural Engineer, Simpson Gumpertz and Heger, San Francisco, California

James R. Harris, President, J. R. Harris and Company, Denver, Colorado

John D. Hooper, Director of Earthquake Engineering, Magnusson Klemencic, Seattle, Washington

E. V. Leyendecker, Research Civil Engineer, U.S. Geological Survey, Denver, Colorado

Technical Subcommittee 2, Design Criteria and Analysis and Advanced Technologies

Chair

John D. Hooper, Director of Earthquake Engineering, Magnusson Klemencic, Seattle, Washington

Members

Mark Aschheim, Professor, Santa Clara University, California

James R. Harris, President, J. R. Harris and Company, Denver, Colorado

Charles Kircher, Principal, Charles Kircher and Associates Consulting Engineers, Palo Alto, California

Finley Charney, Associate Professor, Virginia Polytechnic Institute and State University, Blacksburg

Michael Constantinou, Professor, State University of New York, Buffalo

Martin Johnson, Director ELSR Division, ABS Consulting, Irvine, California

Joe Maffei, Rutherford and Chekene Consulting Engineers, San Francisco, California

Alan Scott, Principal/Division Manager, KPFF Consulting Engineers, St. Louis, Missouri

Corresponding Members

Ian Aiken, Principal, Seismic Isolation Engineering, Piedmont, California

Mohammed Ettouney, Principal, Weidlinger Associates, New York, New York

Subhash Goel, Professor, University of Michigan, Ann Arbor

Husein Hasan, Senior Civil Engineer, Tennessee Valley Authority, Knoxville

Saif Hussain, Managing Principal, SHA Coffman Engineers, Encino, California

Marcelino Iglesias, Code Specialist, New Jersey Division of Codes and Standards, Trenton

Leonard Joseph, Senior Vice President, Thornton-Tomasetti Engineers, New York, New York

Sanj Malushte, Senior Engineering Specialist, Bechtel Corporation, Frederick, Maryland

Kit Miyamoto, President and CEO, Marr Chatter and Miyamoto, West Sacramento, California

Mark Pierepiekarz, MRP Engineering, Newcastle, Washington

Wenshen Pong, Assistant Professor, San Francisco State University, California

Andrei Reinhorn, Professor and Chairman, State University of New York, Buffalo

James Russell, Building Code Consultant, Concord, California

Gary Searer, Senior Engineer, Wiss, Janney, Elstner Associates, Emeryville, California

Sayed Stoman, Chief Engineer, Caldwell Tanks, Peactree City, Georgia

Andrew Taylor, Associate, KPFF Consulting Engineers, Seattle, Washington
 Michael Valley, Associate, Magnusson Klemencic, Seattle, Washington
 Andrew Whittaker, Associate Professor, State University of New York, Buffalo

Technical Subcommittee 3, Mapping, Foundations and Geotechnical Considerations

Chair

C. B. Crouse, Principal Engineer, URS Corporation, Seattle, Washington

Members

Roger Borchardt, Research Engineering Seismologist, U.S. Geological Survey, Menlo Park, California
 E. V. Leyendecker, Research Civil Engineer, U.S. Geological Survey, Denver, Colorado
 Jonathan P. Stewart, Professor, University of California, Los Angeles
 Donald Anderson, Principal Geotechnical Engineer, CH2M Hill, Bellevue, Washington
 Kenneth Campbell, Vice President, ABS Consulting Group, Beaverton, Washington
 Tom Hale, Structural Engineer, OSHPD, Sacramento, California
 Jeffery Kimball, Technical Specialist, National Nuclear Security Administration, Germantown, Maryland
 Nicholas Luco, USGS, Denver, Colorado
 Mark Moore, Senior Associate, Rutherford and Chekene, Oakland, California
 Farhang Ostradan, Chief Soils Engineer, Bechtel Corporation, San Francisco, California
 Maurice Power, Principal Engineer, Geomatrix Consultants, Oakland, California
 Mishac Yegian, Professor, Northeastern University, Boston, Massachusetts

Corresponding Members

Yousef Bozorginia, Associate Director, Pacific Earthquake Engineering Research (PEER), Richmond, California
 Philip Caldwell, Staff Engineer, Square D/ Schneider Electric, Seneca, South Carolina
 Susan Chang, Principal Engineer, Shannon and Wilson, Seattle, Washington
 Paul Cloke, Professor Emeritus, University of Michigan, Prescott, Arizona
 Craig Comartin, President, Comartin-Reis, Stockton, California
 Ricardo Dobry, Professor, Rensselaer Polytechnic Institute, Troy, New York
 Husein Hasan, Senior Civil Engineer, Tennessee Valley Authority, Knoxville
 Tara Hutchinson, Associate Professor, University of California, San Diego
 Jeffery Keaton, Senior Principal Engineering Geologist, MACTEC Engineering and Consulting, Los Angeles, California
 Praveen Malhotra, Senior Research Scientist, FM Global, Norwood, Massachusetts
 Geoffrey Martin, Professor Emeritus, University of Southern California, Los Angeles
 Richard McConnell, Consultant, Springfield, Virginia
 Adrian Rodriguez-Marek, Assistant Professor, Washington State University, Pullman
 Dario Rosidi, Principal Technologist, CH2M Hill, Oakland, California

Technical Subcommittee 4, Concrete Structures

Chair

Neil Hawkins, Professor Emeritus, University of Illinois, Clyde Hill, Washington

Members

S. K. Ghosh, Principal, S. K. Ghosh Associates, Palatine, Illinois
 Sharon L. Wood, Professor of Civil Engineering, University of Texas, Austin
 David Arndt, Associate, KPFF Consulting Engineers, Seattle, Washington
 Ned Cleland, president, Blue Ridge Design, Winchester, Virginia
 W. Gene Corley, Senior Vice President, CTL Group, Skokie, Illinois
 David Gustafson, Vice President of Engineering, Concrete Reinforcing Steel Institute, Schaumburg, Illinois

H.S. Lew, Senior Research Engineer, National Institute of Standards and Technology, Gaithersburg, Maryland
Joe Maffei, Rutherford and Chekene Consulting Engineers, San Francisco, California
Jack Moehle, Professor/Director of Civil Engineering Department, PEER Center, Richmond, California
John Silva, Director Codes and Approvals, Hilti, San Rafael, California
Richard Wollmershauser, Director of Technical Services, HILTI, Tulsa, Oklahoma

Corresponding Members

Husein Hasan, Senior Civil Engineer, Tennessee Valley Authority, Knoxville
Mervyn Kowalsky, Assistant Professor, North Carolina State University, Raleigh
Rene Luft, Principal, Simpson Gumpertz, and Heger, San Francisco, California
Antonio Nanni, Professor, University of Missouri, Rolla

Technical Subcommittee 5, Masonry Structures

Chair

Richard E. Klingner, Professor, University of Texas, Austin

Members

Thomas A. Gangel, Principal, Wallace Engineering Structural Consultants, Tulsa, Oklahoma
Jason J. Thompson, Structural Engineer, National Concrete Masonry Association, Herndon, Virginia
Daniel Abrams, Professor, University of Illinois MAE Center, Urbana
Ronald Barnett, Aercon Florida, Haines City
J. Gregg Borchelt, Vice President, Brick Industry Association, Reston, Virginia
Robert Chittenden, Principal, Chittenden Engineering, Auburn, California
Steve Dill, KPFF Consulting Engineers, Seattle, Washington
David Mclean, Department Chair, Washington State University, Pullman

Corresponding Members

Gregory Kingsley, President and CEO Principal Engineer, KL and A, Golden, Colorado
Robert Lyons, Associate, Brandow and Johnson Associates, Los Angeles, California
Max Porter, Professor, Iowa State University, Ames
Arturo Schultz, Associate Professor, University of Minnesota, Minneapolis
James Tauby, Chief Engineer, Mason Industries, Hauppauge, New York
John Tawresey, KPFF Consulting Engineers, Seattle, Washington
Diane Throop, Consultant, Cincinnati, Ohio
Terence Weigel, Associate Professor, University of Louisville, Kentucky

Technical Subcommittee 6, Steel and Composite Steel and Concrete Structures

Chair

James O. Malley, Senior Principal, Degenkolb Engineers, San Francisco, California

Members

Roberto T. Leon, Professor, School of Civil and Environmental Engineering, Georgia Institute of Technology, Atlanta, Georgia
Bonnie Manley, Regional Director American Iron and Steel Institute, Norfolk, Massachusetts
Michael Cochran, Associate principal, Weidlinger Associates, Inc., Los Angeles, California
Jerome Hajjar, Professor, University of Illinois at Urbana-Champaign, Urbana
C. Mark Saunders, President, Rutherford and Chekene Consulting Engineers, San Francisco, California
W. Lee Shoemaker, Director of Research and Engineering, Metal Building Manufacturers Association, Cleveland, Ohio
Kurt Swensson, President, KSI / Structural Engineers, Atlanta, Georgia
Chia-Ming Uang, Professor, University of California-San Diego, La Jolla, California

Corresponding Members

Michel Bruneau, Professor, Department of Civil, Structural, and Environmental Engineering, State University of New York, Buffalo

Scott Civjan, Assistant Professor, University of Massachusetts, Amherst

Gregory Deierlein, Professor, Stanford University, Stanford, California

Cynthia Duncan, Director of Specifications, American Institute of Steel Construction, Chicago, Illinois

Jeff Ellis, Code Report and Branch Engineering Manager, Simpson Strong-Tie, Brea, California

Subhash Goel, Professor, University of Michigan, Ann Arbor

Husein Hasan, Senior Civil Engineer, TVA, Knoxville, Tennessee

Neil Hawkins, Professor Emeritus, Clyde Hill, Washington

Jay Larson, American Iron and Steel Institute, Bethlehem, Pennsylvania

Terry Lundeen, Principal, Coughlin Porter Lundeen, Seattle, Washington

Robert Lyons, Associate, Brandow and Johnston Associates, Los Angeles, California

Wenshen Pong, Assistant Professor, San Francisco State University, California

Rafael Sabelli, Director of Seismic Design, WALTER P. MOORE, San Francisco, California

Stephen Schneider, Kramer-Gehlen and Associates, Vancouver, Washington

Bahram Shahrooz, Associate Professor, University of Cincinnati, Ohio

Bozidar Stojadinovic, Assistant Professor, University of California, Berkeley

James Thomas, TLC Engineering for Architecture, Cocoa, Florida

Steven Thomas, Division Engineer, Butler Construction, Kansas City, Missouri

Technical Subcommittee 7, Wood Structures***Chair***

Kelly Cobeen, Associate Principal, Wiss, Janney, Elstner Associates, Emeryville, California

Part 1 - Members

J. Daniel Dolan, Professor, Washington State University, Pullman, Washington

Philip Line, Manager, Engineering Research, American Forest and Paper Association, Washington, DC

Philip Brazil, Senior Engineer, Reid Middleton, Everett, Washington

Robert Chittenden, Principal, Chittenden Engineering, Auburn, California

Andre Filiatrault, Deputy Director MCEER, State University of New York, Buffalo

Robert George, Architect, South San Francisco, California

Erol Karacabeyli, Manager Wood Engineering Department, Forintek Canada Corporation, Vancouver, BC

Vladimir Kochkin, Research Engineer, National Association of Home Builders Research, Upper Marlboro, Maryland

James Mahaney, Principal, Wiss, Janney, Elstner Associates, Auburn, California

Gary Mochizuki, Principal Structural Engineer, Structural Solutions, Inc., Walnut Creek, California

Rawn Nelson, Structural Engineer, R.F. Nelson and Associates, Hermosa Beach, California

Steven Pryor, Building Systems R & D Manager, Simpson Strong-Tie, Pleasanton, California

Thomas Skaggs, Manager, Product Evaluation, APA-The Engineered Wood Association, Tacoma, Washington

Corresponding Members

David Adams, Structural Engineer, Tulare, California

Scott Beard, Structural Engineer, City of Tacoma, Washington

Kevin Cheung, Director, Technical Services, Western Wood Products Association, Portland, Oregon

Patrick Edwards, Vice President/Director of Engineering, TP Engineering, Trussville, Alabama

Jeff Ellis, Code Report & Branch engineering Manager, Simpson Strong-Tie, Brea, California

Rick Fine, Structural Engineer, Fine Engineering, Snohomish, Washington

Robert Johnson, President, R.I. Johnson and Associates, Wheaton, Illinois

Jay Larson, American Iron and Steel Institute, Bethlehem, Pennsylvania
Bonnie Manley, Regional Director, American Iron and Steel Institute, Walpole, Massachusetts
Zeno Martin, Engineer, APA-The Engineered Wood Association, Tacoma, Washington
Frank Park, Supervisor of Engineering/Construction Plan Review, County of Guilford, Greensboro, North Carolina
Marjan Popovski, Research Scientist - Building Systems Department, Forintek, Vancouver, BC, Canada
Douglas Rammer, Research Engineer, USDA Forest Products Laboratory, Madison, Wisconsin
Colin Rogers, Professor, McGill University, Montreal, QC, Canada
Richard Silva, Seismic Safety Program Manager, National Park Service, Denver, Colorado
Howard Smith, District Structural Engineer, Division of the State Architect, Department of General Services, Sacramento, California
Charles Spitz, Architect-Planner-Code Consultant, Wall, New Jersey
John van de Lindt, Associate Professor, Department of Civil Engineering, Colorado State University, Fort Collins

Technical Subcommittee 8, Nonstructural Components and Nonbuilding Structures

Chair

J. G. (Greg) Soules, Principal Engineer, Chicago Bridge and Iron, The Woodlands, Texas

Members

John D. Gillengerten, Senior Structural Engineer, Office of Statewide Health and Planning and Development, Sacramento, California
Harold Sprague, Structural Project Engineer, Black and Veatch Special Projects Corporation, Overland Park, Kansas
Robert E. Bachman, Principal, RE Bachman Consulting Engineers, Laguna Niguel, California
Victor Azzi, Consulting Structural Engineer, RMI, Rye, New Hampshire
Philip Caldwell, Staff Engineer, Square D / Schneider Electric, Seneca, South Carolina
Susan Dowty, Structural, Seismic and Code Consultant, S. K. Ghosh Associates, Laguna Niguel, California
James Lake, Fire Protection Engineer, NFPA International, Quincy, Massachusetts
Patrick Lama, Vice President, Mason Industries, Hauppauge, New York
Ronald Haupt, Senior Consultant, Pressure Piping Engineering Associates, Foster City, California
Sanj Malushte, Senior Engineering Specialist, Bechtel Corporation, Frederick, Maryland
John Silva, Director Codes and Approvals, Hilti, San Rafael, California
Jeffery R. Soulages, Facilities Systems Engineering Manager, INTEL, Hillsboro, Oregon

Corresponding Members

David Adams, Structural Engineer, Tulare, California
Scott Ashford, Professor and Chair, Oregon State University, Corvallis
Antonia Braga, Senior Engineer, FM Global, Woodland Hills, California
Martin Eskijian, Supervisor Engineering Branch, California State Land Commission, Long Beach
Husein Hasan, Senior Civil Engineer, TVA, Knoxville, Tennessee
Douglas Honegger, Principal, D.G. Honegger Consulting, Arroyo Grande, California
Francis Jehrio, Engineering Specialist, York International Corporation, York, Pennsylvania
Brian Kehoe, Consultant, Emeryville, California
Theodore Lemoff, Principal Gases Engineer, NFPA International, Quincy, Massachusetts
John Loscheider, Principal, Loscheider Engineering Company, Renton, Washington
Panos G. Papavizas, Manager, Engineering Systems and Processes, Baltimore Aircoil Company, Jessup, Maryland
Rolf Pawski, Landmark Structures, Wheaton, Illinois
Mark Pierepiekarz, MRP Engineering, Newcastle, Washington
Denis Radecki, Senior Structural Engineer, Hamon Custodis, Brazil, Indiana
David Sheppard, Structural Engineer, D.A. Sheppard Consulting Engineer, Sonora, California

Richard Silva, Seismic Safety Program Manager, National Park Service, Denver, Colorado
Anthony Shelton, Mechanical Engineer, Kone, Inc., McKinney, Texas
Charles Spitz, Architect-Planner-Code Consultant, Wall, New Jersey
John Stevenson, Senior Consultant, Stevenson and Associates, Cleveland, Ohio
William Stewart, Architect, Stewart-Schaberg/Architects, Chesterfield, Missouri
Victoria Valentine, Manager of Product Standards, National Fire Sprinkler Association, Patterson, New Jersey
Michael Werner, Deputy public Works Director, Code Enforcement, County of St. Louis, Missouri
Peter Yin, Section Head, Structures, Port of Los Angeles, San Pedro, California

Seismic Design Procedures Review Group

Chair

Charles Kircher, Principal, Charles Kircher and Associates Consulting Engineers, Palo Alto, California

Members

C. B. Crouse, Principal Engineer, URS Corporation, Seattle, Washington
Bruce Ellingwood, Professor of Civil Engineering, Georgia Institute of Technology, Atlanta
Ronald O. Hamburger, Senior Principal, Simpson Gumpertz and Heger, San Francisco, California
James R. Harris, President, J. R. Harris and Company, Denver, Colorado
William Holmes, Vice President, Rutherford and Chekene Engineers, San Francisco, California
John Hooper, Director of Earthquake Engineering, Magnusson Klemencic, Seattle, Washington
Jeffery Kimball, Technical Specialist, National Nuclear Security Administration, Germantown, Maryland
Nicholas Luco, U.S. Geological Survey, Denver, Colorado
Andrew Whittaker, Associate Professor, State University of New York, Buffalo

Issue Team 1, Performance Criteria

Chair

William Holmes, Vice President, Rutherford and Chekene Engineers, San Francisco, California

Members

Robert E. Bachman, Principal, RE Bachman Consulting Engineers, Laguna Niguel, California
Bruce Ellingwood, Professor of Civil Engineering, Georgia Institute of Technology, Atlanta
Charles Kircher, Principal, Charles Kircher and Associates Consulting Engineers, Palo Alto, California
E. V. Leyendecker, Research Civil Engineer, U.S. Geological Survey, Denver, Colorado

Issue Team 2, Design Parameters

Chair

Robert E. Bachman, Principal, RE Bachman Consulting Engineers, Laguna Niguel, California

Vice Chair

John D. Hooper, Director of Earthquake Engineering, Magnusson Klemencic, Seattle, Washington

Members

James R. Harris, President, J. R. Harris and Company, Denver, Colorado
Richard Klingner, Professor, University of Texas, Austin
C. Mark Saunders, President, Rutherford and Chekene Engineers, San Francisco, California
S. K. Ghosh, Principal, S. K. Ghosh and Associates, Palatine, Illinois
Dan Dolan, Professor, Washington State University, Pullman

Issue Team 3, Foundation Design Requirements

Chair

Martin Johnson, Director ELSR Division, ABS Consulting, Irvine, California

Members

J. G. (Greg) Soules, Principal Engineer, Chicago Bridge and Iron, The Woodlands, Texas

John D. Gillengerten, Deputy Director, Office of Statewide Health and Planning and Development, Sacramento, California

Rick Drake, Director of Design Engineering, Fluor-Daniel Engineering, Aliso Viejo California

Marshall Lew, Vice President, MACTEC Engineering and Consulting, Los Angeles, California



FEMA

FEMA P-750
Catalog No. 09349-2